

STUDER reVOX

B739

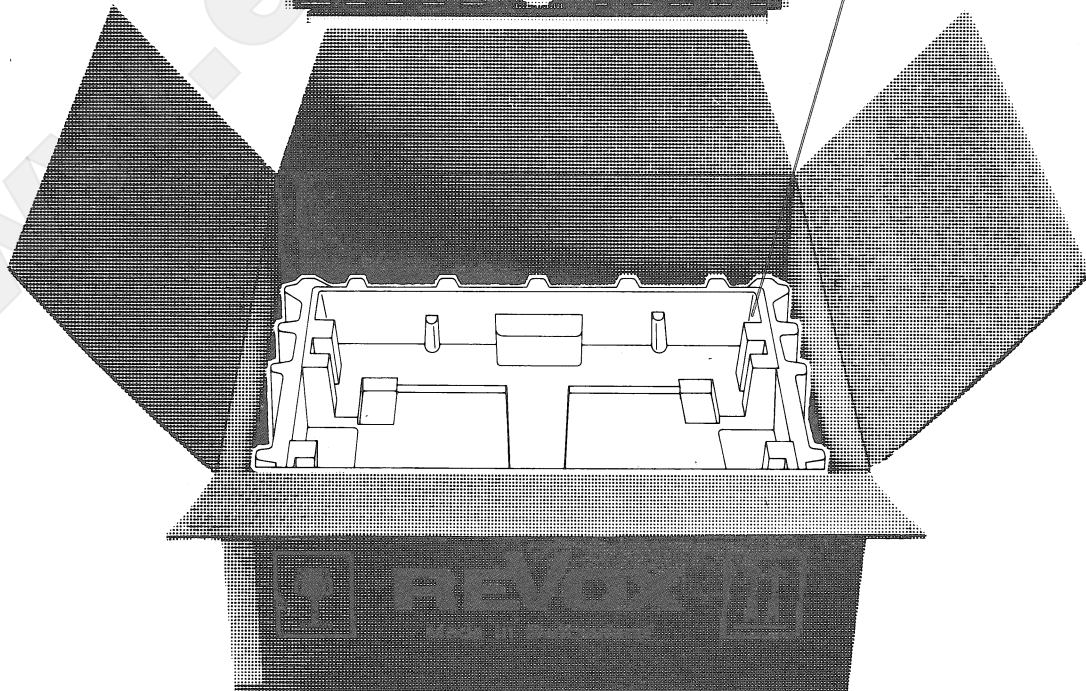

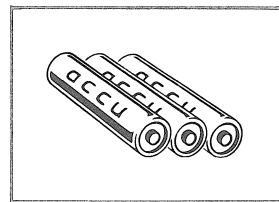
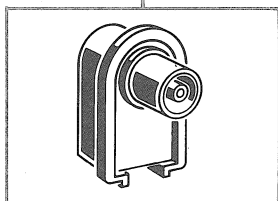
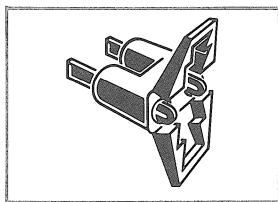
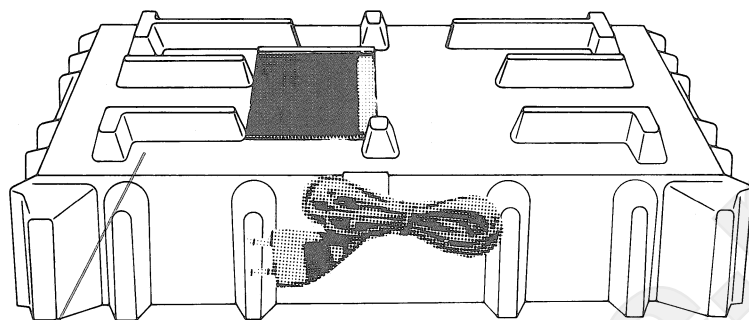

BEDIENUNGSANLEITUNG REVOX B739

VERPACKUNG

Bewahren Sie die Original-Verpackung auf. Bei einem Transport ist diese Spezialverpackung der beste Schutz für Ihr wertvolles Gerät.

WICHTIGE HINWEISE

Schützen Sie Ihr Gerät vor übermässiger Hitze und Feuchtigkeit. Stellen Sie es so auf, dass Lüftungsschlitze nicht verdeckt werden.

Vor dem Öffnen des Gerätes unbedingt den Netzstecker ausziehen. Das Gerät darf nur an Wechselspannungsnetze (50 ... 60 Hz) angeschlossen werden. Die Netzspannung kann am Spannungswähler auf der Rückseite des Gerätes im Bereich 100/120/140 V und 200/220/240 V der örtlichen Stromversorgung angepasst werden.

STATION	FREQUENZ	OBEN1		2			3
STATION	FREQUENZ	UNTEN1		2			3
		4		5			6
		4		5			6
		7		8			9
		7		8			9

Printed in Switzerland
 by WILLI STUDER 18.631.980
 Copyright by WILLI STUDER
 CH-8105 Regensdorf-Zurich

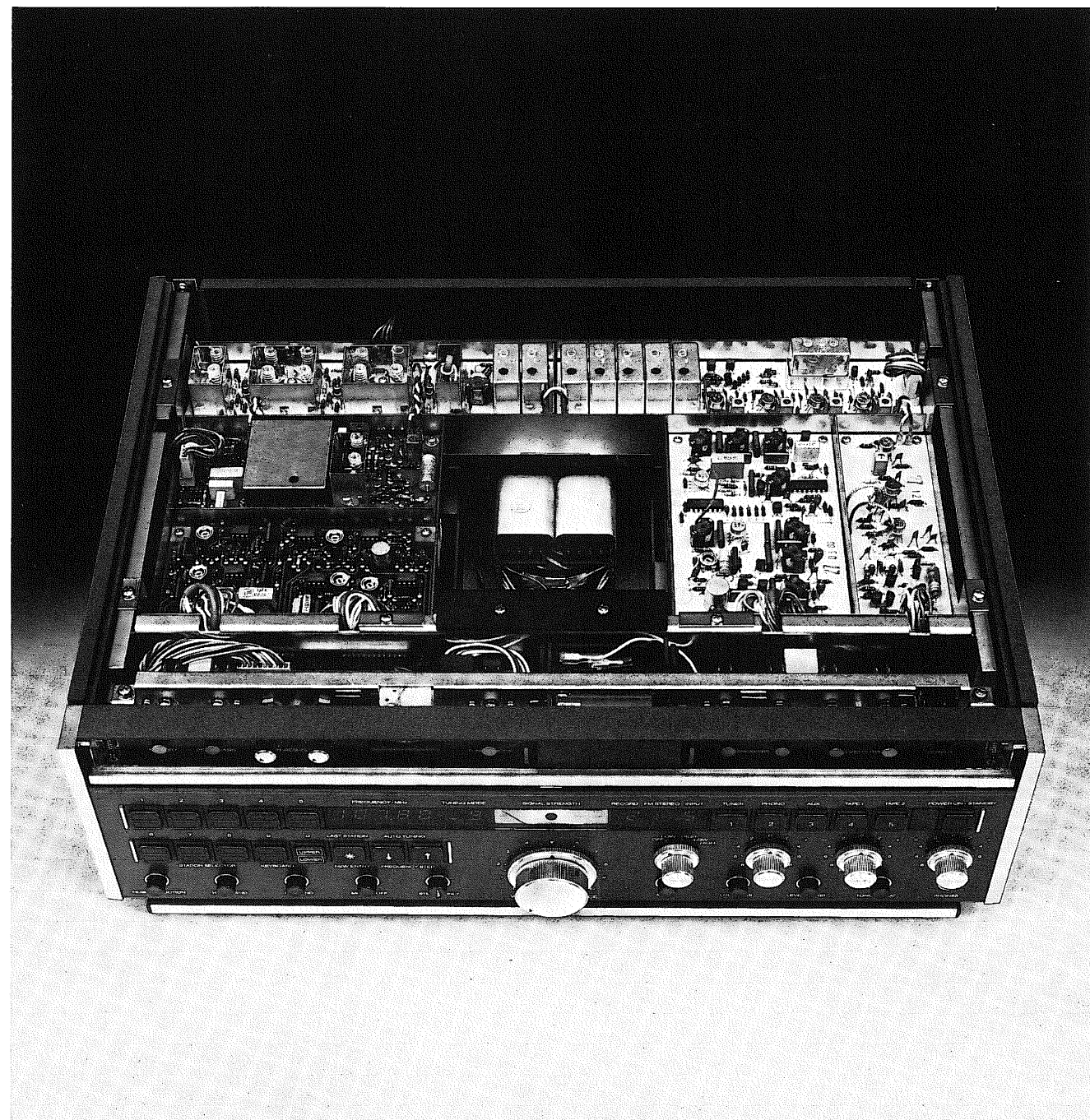

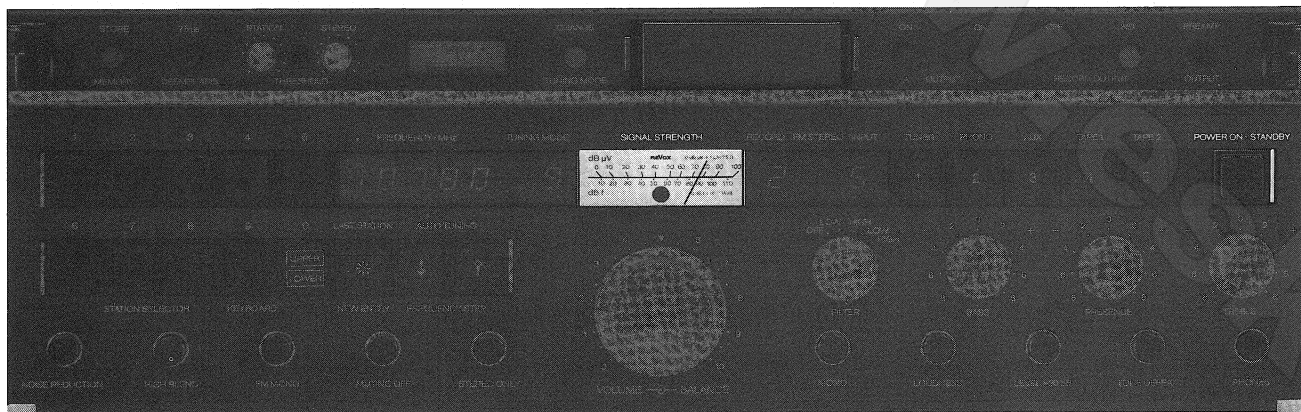

EINSCHALTEN, STROMVERSORGUNG, AKKUS FÜR STATIONSSPEICHERUNG



EMPFANGSTEIL, STATIONSSPEICHERUNG, AUTOMATISCHER SUCHLAUF



EINGANGSUMSCHALTUNG, AUSGANGSWAHL, FRONTPLATTENAUSGÄNGE

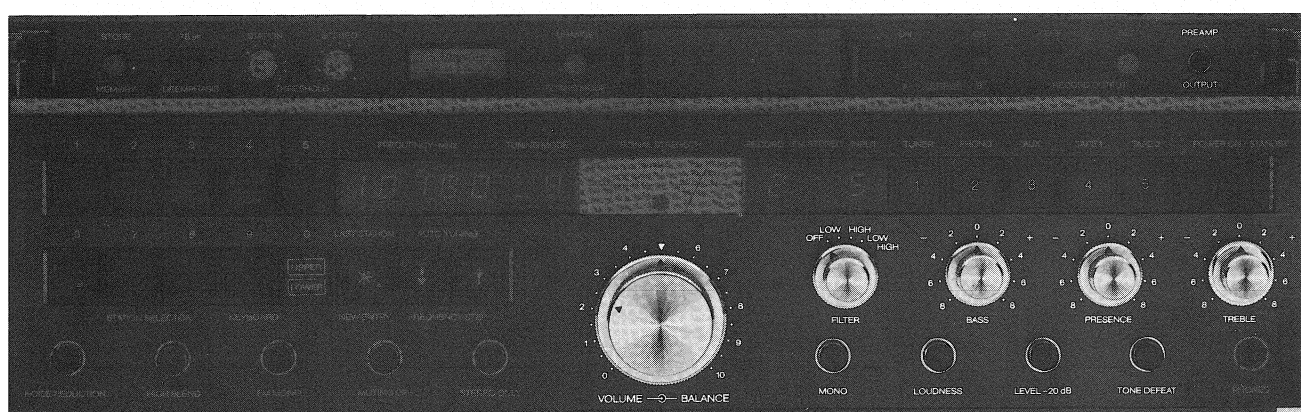

LAUTSTÄRKE, BALANCE, KLANGREGELUNG, FILTER

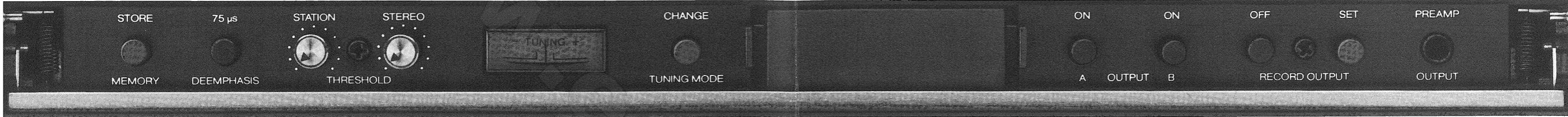

SPEICHERN

NACHENTZERRUNG
75 MIKROSEKUNDEN

SCHALTSCHWELLE
STATION

UMSCHALTSCHWELLE
STEREO

ABSTIMMUNG

WECHSEL
der ABSTIMM-ART

AKKU

LAUTSPRECHER
GRUPPE (A) EIN

AUSGANG

LAUTSPRECHER
GRUPPE (B) EIN

AUS (gelöscht)

AUFNAHME-AUSGANG

PROGRAMMIEREN

VORVERSTÄRKER-
AUSGANG

STORE
MEMORY

75 μs
DEEMPHASIS

STATION
THRESHOLD

STEREO



CHANGE
TUNING MODE

ON
A OUTPUT

ON
B

OFF
RECORD OUTPUT

SET

PREAMP
OUTPUT

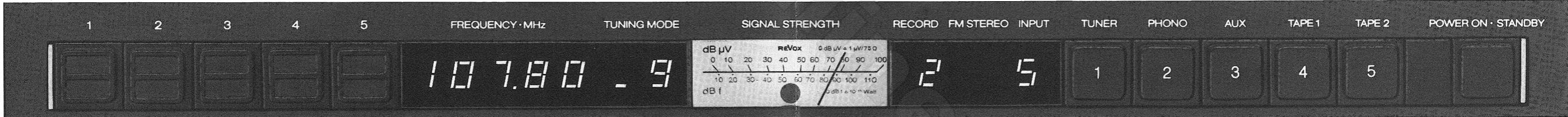

STATIONS-WAHL
TASTENFELD

FREQUENZ/MEGAHERTZ

ABSTIMM-ART

EMPFANGSSIGNAL
STÄRKE

AUFNAHME

STEREO-EMPFANG

EINGANG

EMPFANGSTEIL

PLATTENSPIELER

HILFS-/RESERVE-
EINGANG

TONBANDGERÄT 1

TONBANDGERÄT 2

NETZ EIN

BEREITSCHAFT

1 2 3 4 5

FREQUENCY · MHz

TUNING MODE

SIGNAL STRENGTH

RECORD FM STEREO INPUT TUNER PHONO AUX TAPE 1 TAPE 2 POWER ON · STANDBY

107.80 . 9



RECORD

FM STEREO

INPUT

TUNER

PHONO

AUX

TAPE 1

TAPE 2

POWER ON · STANDBY

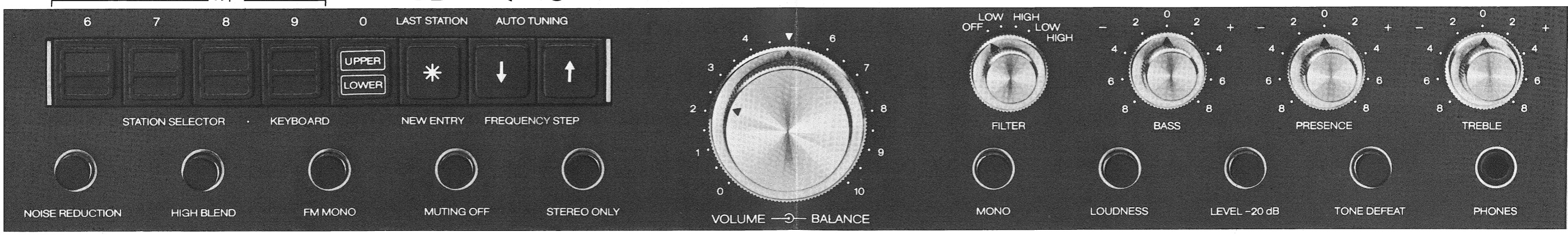

STATIONS-WAHL
TASTENFELD

UNTERE SPEICHERGRUPPE
OBERE

LETZTE STATION
NEUE EINGABE

AUTOM. ABSTIMMUNG
FREQUENZSCHRIFF
(25 kHz)

FILTER

TIEFENREGLER

PRÄSENZREGLER

HÖHENREGLER

6 7 8 9 0

LAST STATION AUTO TUNING

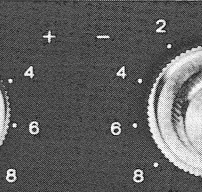
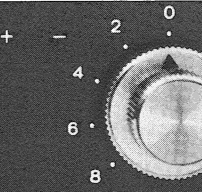
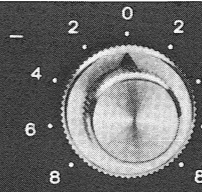
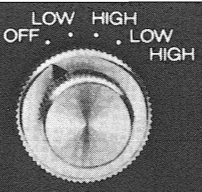
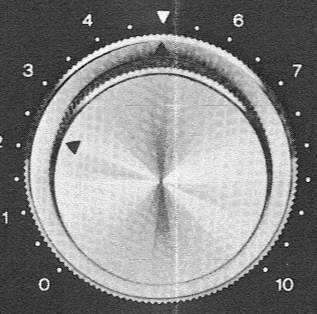

STATION SELECTOR

KEYBOARD

NEW ENTRY

FREQUENCY STEP

VOLUME — BALANCE

FILTER

BASS

PRESENCE

TREBLE

NOISE REDUCTION

HIGH BLEND

FM MONO

MUTING OFF

STEREO ONLY

MONO

LOUDNESS

LEVEL -20 dB

TOPE DEFEAT

PHONES

RAUSCHVERMINDERUNG

KANALTRENNUNG

MONOEMPfang

RAUSCHSPERRE AUS

NUR STEREOSENDER

LAUTSTÄRKE

BALANCE

MONOWIEDERGABE

GEHÖRRICHTIGE
LAUTSTÄRKEREGELUNG

LAUTSTÄRKEABSENKUNG
(linear auf 25%)

KLANGREGELUNG
ÜBERBRÜCKEN

KOPFHÖRER

HINWEIS

Damit Sie den B739 möglichst schnell kennenlernen und mit seiner Bedienung vertraut werden, empfehlen wir Ihnen, die vorliegende Bedienungsanleitung Seite 2 bis 16 Schritt für Schritt zu studieren und die beschriebenen Vorgänge an Ihrem Gerät zu vollziehen.

ANSCHLIESSEN/INBETRIEBNAHME

2

BEDIENUNGSANLEITUNG EMPFANGSTEIL

Automatischer Suchlauf	5
Speichern von Empfangsfrequenzen	7
Abruf gespeicherter Empfangsfrequenzen	8
Eintippen einer bekannten Frequenz	9
Stereoempfang	10
Manueller Suchlauf	12
Rauschverminderung	12

BEDIENUNGSANLEITUNG VERSTÄRKERTEIL

Wahl der Signalquellen/Eingangswahl	13
Tonbandaufnahmen	14
Klangregler	15
Filter	16
Weitere Funktionen der Verstärkerteils	16
Zusätzliche Technische Daten	17

DIVERSES

Organisation des StationsSpeichers	17
Garantiebestimmungen	17
UKW-Antennen	18
Laufzeitverzerrungen durch Mehrwegempfang	19
Belegung der Steckbuchsen	20
REVOX-Verbindungskabel	20
Zusammenschalten einer REVOX-Anlage, Functional Diagram	Einband hinten

ANSCHLIESSEN/INBETRIEBNAHME

Abdeckklappe nach unten klappen

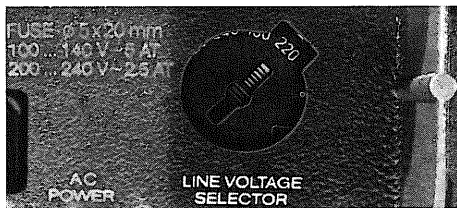
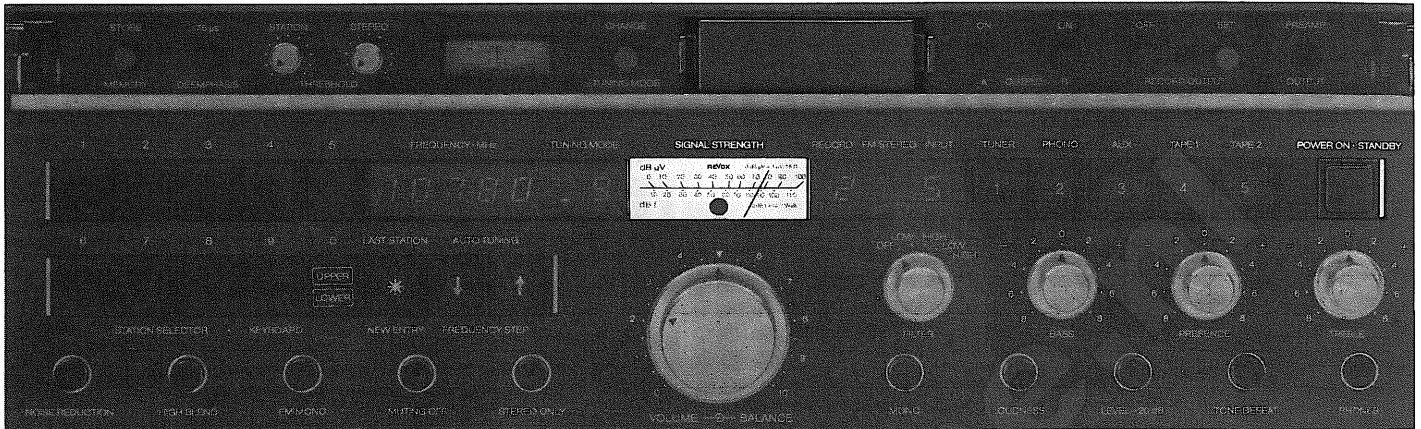

SPANNUNGSWÄHLER KONTROLLIEREN
eventuell auf örtliche Netzspannung einstellen.

Stromversorgung: 100, 120, 140, 200, 220, 240 V ~ \pm 10%, 50 ... 60 Hz
Leistungsaufnahme: 50 W max.



NETZSICHERUNG KONTROLLIEREN
für 100 ... 140 V: 630 mA (träge)
für 200 ... 240 V: 315 mA (träge)

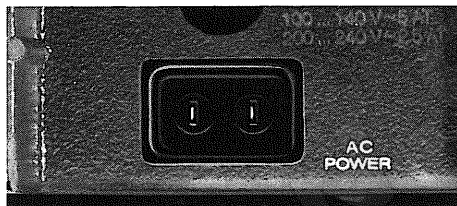

NETZKABEL AM GERÄT ANSCHLIESSEN
Nur das mitgelieferte Netzkabel verwenden

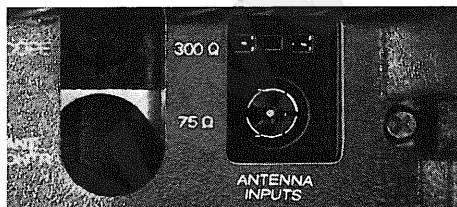

ANTENNE ANSCHLIESSEN

60 ... 75 Ohm mit Koaxialstecker, nach DIN 45325 oder
240 ... 300 Ohm, symmetrisch, Flachstecker, nach DIN 45316

Der Koaxialeingang ist vorzuziehen: Neben der besseren Abschirmung gegen Stör-Einstrahlung fällt wegen dem nicht benötigten Symmetrier-Übertrager (Empfängerweiche) eine Signaldämpfung von ca. 0,5 ... 1,5 dB weg.

Siehe auch Seite 18

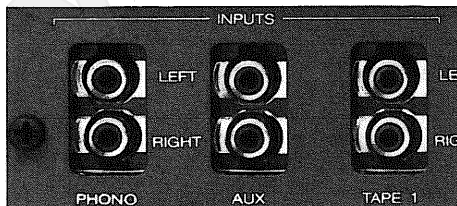

SIGNALQUELLEN ANSCHLIESSEN Siehe auch Seite 20 und Einband hinten.

PHONO: Plattenspieler mit magnetischer Tonzelle

Eingangsempfindlichkeit: 3 mV/47 kOhm, 220 pf (für 2 V Ausgangsspannung). Fremdspannungsabstand > 73 dB (5 mV/1 kHz). Phonoentzerrung (IEC 98, MOD. 4 1976): \pm 0,5 dB, 20 Hz ... 20 kHz

AUX: Hilfs-/Reserve-Eingang (für MW/LW/KW-Radios etc.)

TAPE 1: Tonbandgerät 1

AUX, TAPE: Empfindlichkeit für 2 V: 150 mV/50 kOhm. Fremdspannungsabstand > 90 dB

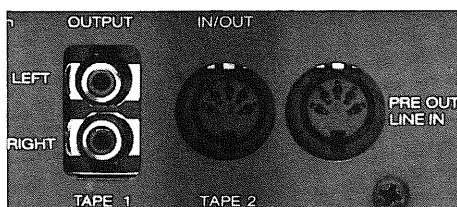

TAPE 2: Tonbandgerät 2 oder Kassettengerät (DIN-Anschluss)

HINWEIS:

In allen nichtbenützten Eingängen die roten Kurzschlussstecker eingesteckt lassen!

Durch die Kurzschlussstecker werden Geräuschspannungsabstände und Übersprechdämpfung verbessert.

Übersprechdämpfung (bei 1 kHz): alle Eingänge grösser als 70 dB

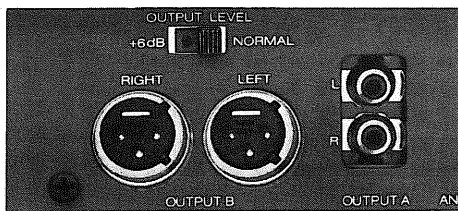

ENDVERSTÄRKER ANSCHLIESSEN

OUTPUT A: Cinch-Anschlüsse

OUTPUT B: XLR-Anschlüsse

Ausgangsspannung: 2 V; Ausgangsimpedanz: 220 Ohm

OUTPUT LEVEL: Umschalten der Ausgangsspannung auf 4 V (+6 dB)

+6 dB entspricht einer Verdoppelung; für unempfindliche Endstufen.



KOPFHÖRER ANSCHLIESSEN

Kopfhörersysteme mit 8 Ohm und mehr sind geeignet.

Der Kopfhörerausgang ist unabhängig von der gewählten Ausgangsgruppe immer in Betrieb.

Stereo-Jack-Stecker: 11,8 V/optimale Last 200 ... 800 Ohm

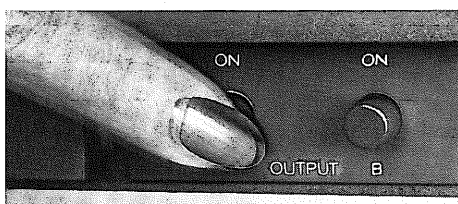

GEWÜNSCHTE AUSGANGSGRUPPE WÄHLEN

Taste A: Cinch-Ausgang

Taste B: XLR-Ausgang

A + B: beide Ausgangsgruppen gleichzeitig

Kopfhörerbetrieb ist auch bei ausgeschalteten Tasten A und B möglich.

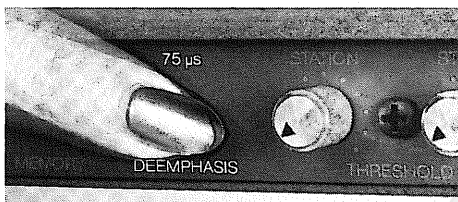

DEEMPHASIS

Für Europa: 50 μ s

Taste ausgeschaltet

Für USA: 75 μ s

Taste gedrückt

Bei eingesetztem Rauschverminderungssystem und gedrückter Taste NOISE REDUCTION ist die Nachentzerrung von 25 μ s wirksam.

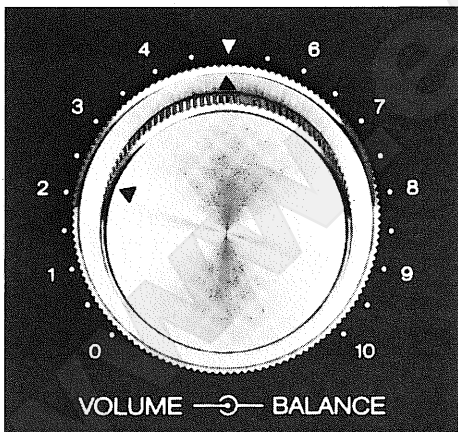

LAUTSTÄRKEREGLER VOLUME

ungefähr auf Stellung 2

BALANCE

in Mittelstellung

Gehörriichtige Lautstärkeregelung: Siehe Seite 16

Balanceregler: zur Kompensation unterschiedlicher Aussteuerung der Kanäle oder unsymmetrischer Aufstellung der Lautsprecher.

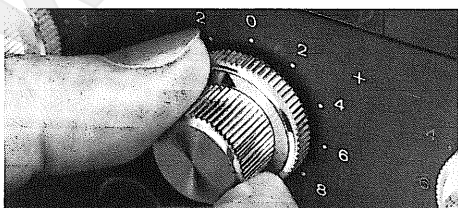

KLANGREGLER IN MITTELSTELLUNG

Weitere Informationen Seite 15



FILTER AUSSCHALTEN (OFF)

Weitere Informationen Seite 16

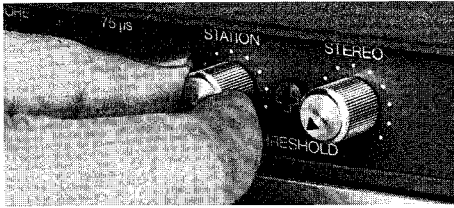

REGLER THRESHOLD STATION UND STEREO AUF MINIMUM DREHEN Pfeil auf Anschlag links

Schaltschwelle STATION: 2... 20 μ V an 75 Ohm
Umschaltswelle STEREO: 5... 500 μ V an 75 Ohm
für Stereo-Empfang.



UNTÉRSTE REIHE RUNDER TASTEN AUSSCHALTEN

Rastende Tasten: Beim Drücken rastet die Taste ein,
nochmaliges Drücken schaltet sie aus.

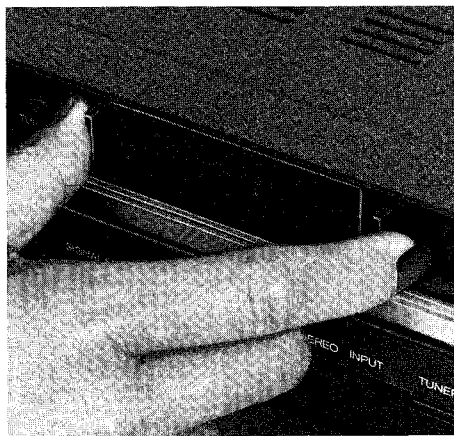

EINSETZEN DER AKKUMULATOREN

Der elektronische Stationspeicher ist auch bei ausgeschaltetem Gerät mit Strom versorgt. Um bei Netzunterbruch ein Löschen des Stationspeichers und damit den Verlust der gespeicherten Empfangsfrequenzen zu verhindern, sollen die beigelegten drei Akkumulatoren (Typ IEC KR 15/51) eingebaut werden.

LASCHEN ZUSAMMENDRÜCKEN UND BATTERIEFACH HERAUSZIEHEN. Papier entfernen.

Akkus einsetzen. Auf Polarität achten; im Boden des Batteriefachs sind die Akkusilhouetten sichtbar.

ACHTUNG:

Es dürfen keine Trockenbatterien (Alkali etc.) eingesetzt werden!

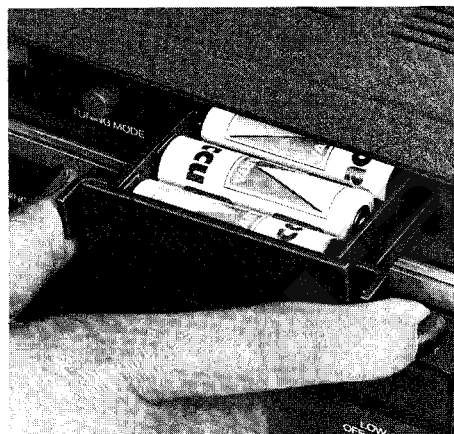

BATTERIEFACH EINSCHIEBEN UND EINRASTEN

LADUNG der Akkus erfolgt bei eingestecktem Netzkabel. Der Receiver kann aus- oder eingeschaltet sein.
LADEZEIT für entladene Akkus: ca. 3 Tage. Wegen des geringen Ladestroms ist Überladen nicht möglich.
NETZUNTERBRUCH: Vollgeladene Akkus erhalten den Speicherinhalt für ca. 1 Woche.

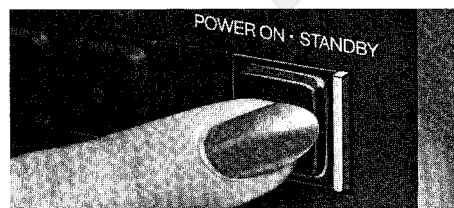

NETZSTECKER IN STECKDOSE EINSTECKEN NETZSCHALTER POWER BETÄTIGEN

Die Taste ist rastend; nochmaliges Drücken schaltet den Receiver aus.

DER RECEIVER IST NACH 3 SEKUNDEN BETRIEBSBEREIT

Abstimm-Instrument SIGNAL STRENGTH:

Mit dem Einschalten wird das Messinstrument beleuchtet.
Beim ersten Einschalten können die Zahlen-Anzeigen beliebige Betriebszustände anzeigen.

Bei späterem Wiedereinschalten wird der zuletzt benützte Stationspeicher angezeigt; gleichzeitig werden die zuletzt benützten Eingangskanäle wieder zugeschaltet und angezeigt.



BEDIENUNGSANLEITUNG EMPFANGSTEIL

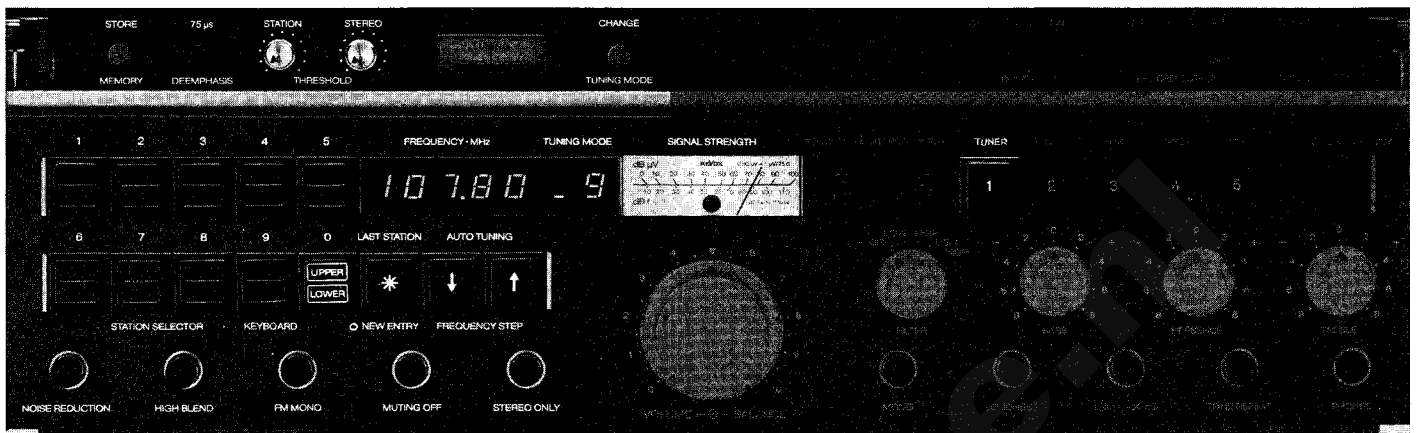

HINWEIS

Die Abbildungen links zeigen die zu betätigenden Bedienelemente. Die Abbildungen rechts zeigen die nach dem Betätigen der Bedienelemente angezeigten Betriebszustände. Alle in dieser Bedienungsanleitung vorkommenden Empfangsfrequenzen (Anzeige FREQUENCY · MHz) sind Beispiele; verlangen Sie von Ihrem Fachhändler eine Frequenztafel Ihrer Region.

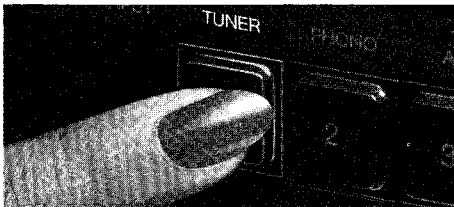

Taste TUNER antippen. Die Anzeige INPUT zeigt «1». Dies bedeutet, dass der Empfangsteil auf die Verstärkerstufe geschaltet ist.

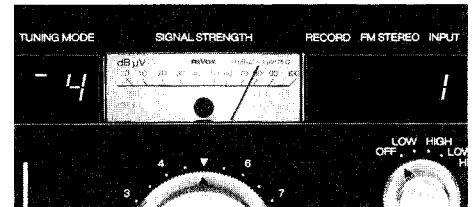

AUTOMATISCHER SUCHLAUF

Mit dem automatischen Suchlauf wird der gesamte Empfangsbereich von 87,5 bis 107,95 MHz in 100 kHz-Schritten abgetastet. Vorhandene Sender mit ausreichender Signalstärke werden exakt abgestimmt. Die Abstimmung der Sender erfolgt im 50 kHz-Raster (z.Bsp. 89,850 MHz)

ACHTUNG:

Die Anzeige TUNING MODE zeigt nach dem Einschalten des Receivers immer eine Zahl (1 ... 9). Falls, verursacht durch später beschriebene Manipulationen, ein «F» (Frequenz-eingabe-Modus) aufleuchtet, ist durch Betätigen der Taste CHANGE TUNING MODE wieder auf den Stations- und Suchlauf-Modus umzuschalten.

BEISPIEL FÜR DAS SUCHEINER STATION

Der Suchvorgang beginnt bei der angezeigten Frequenz oder, wenn die Frequenzanzeige dunkel ist, bei 87,50 MHz (vorwärts) bzw. 107,95 MHz (rückwärts).

Annahme:
Die Frequenz 98,50 MHz wird angezeigt.

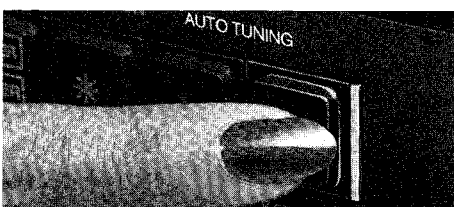

AUTO TUNING ↑ antippen
Suchlauf vorwärts
Frequenzanzeige läuft

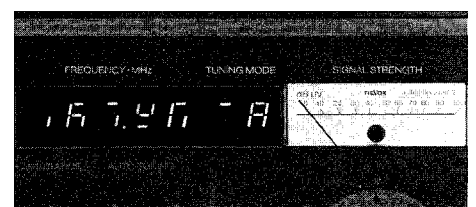
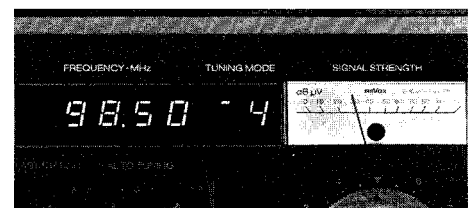

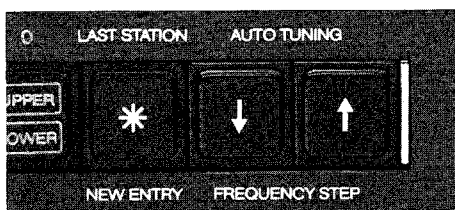

FREQUENZANZEIGE STEHT
Ein Sender mit 98,80 MHz (Beispiel!) wird empfangen und ist quarzgenau abgestimmt.

Genauigkeit der Quarzreferenz:
 $\pm 0.0025\%$

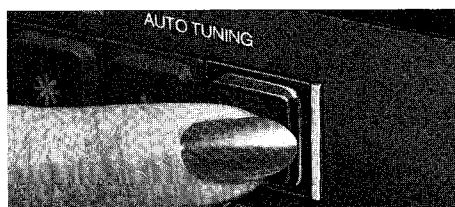
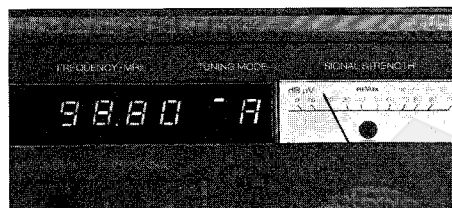

AUTO TUNING ↑
Suchlauf vorwärts

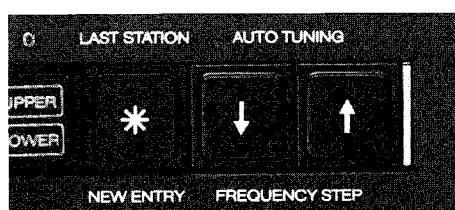
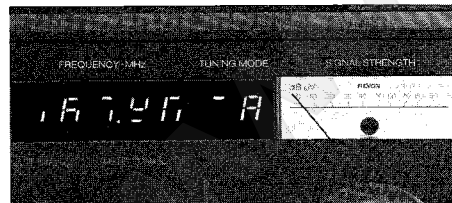

Ein Sender mit 99,10 MHz (Beispiel!) wird empfangen.

Anzeige der Signalstärke SIGNAL STRENGTH
0...100 dB μ V (0 dB μ V \triangleq 1 μ V/75 Ohm)
10...110 dBf (0 dBf \triangleq 10⁻¹⁵ W)

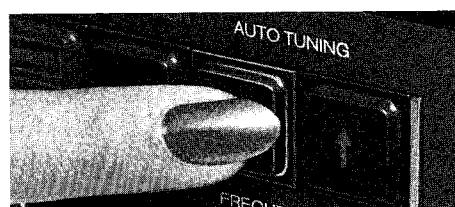
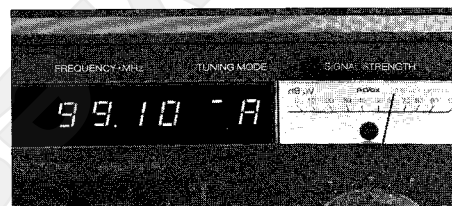

AUTO TUNING ↓
Suchlauf rückwärts

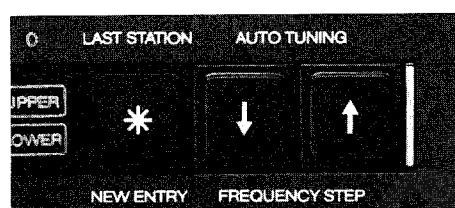
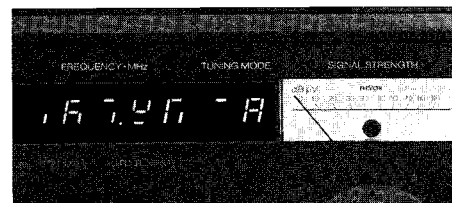

Der Sender mit 98,80 MHz wird wieder empfangen.

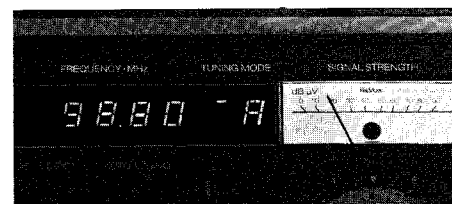

Durch dauerndes Betätigen der Tasten AUTO TUNING lässt sich die Frequenzanzeige mit erhöhter Geschwindigkeit vorwärts oder rückwärts verstellen.

Dabei werden aber keine Stationen gesucht. Nach dem Loslassen wird wieder der normale Suchlauf aufgenommen bis eine Station gefunden ist.

Weitere technische Daten des Empfangsteils:

Spiegelfrequenzdämpfung:	106 dB; $\Delta f = 2 \times f_{ZF}$
Zwischenfrequenzdämpfung:	110 dB; f_{ZF}
Nebenwellendämpfung:	106 dB; $\Delta f = f_{ZF}/2$
Übernahmeverhältnis:	0,8 dB, gemessen mit 40 kHz Hub, 30 dB Signal-/Rauschabstand und 1 mV an 75 Ohm Antennenspannung
Trennschärfe:	80 dB, Nutzsignal 100 μ V an 75 Ohm, Störsignal 1 mV an 75 Ohm moduliert mit 40 kHz Hub
AM-Unterdrückung:	70 dB, bezogen auf 75 kHz Hub, 30% AM 400 Hz und 1 mV an 75 Ohm Antennenspannung
Frequenzgang:	30 Hz ... 15 kHz \pm 1 dB gemessen mit 40 kHz Hub und 1 mV an 75 Ohm Antennenspannung
NF-Verzerrungen	0,075%, gemessen mit 40 kHz Hub 1 kHz, Mono und Stereo L = R, 1 mV an 75 Ohm Antennenspannung

**SPEICHERN
VON EMPFANGSFREQUENZEN**

Jede in der Anzeige FREQUENCY · MHz angezeigte Frequenz kann in einen der 18 Stationsspeicher überschrieben werden. Die Nummern dieser Speicher werden in der Anzeige TUNING MODE angezeigt. Ein Leuchtbalken vor der Zahl identifiziert die Speichergruppe: Balken $\bar{\quad}$ (oben) für Speichergruppe 1 ... 9 OBEN, Balken $_$ (unten) für Speichergruppe 1 ... 9 UNTEN.

Die Speicher sind wie folgt nummeriert:

OBEN (UPPER): $\bar{1}$, $\bar{2}$, $\bar{3}$, $\bar{4}$, $\bar{5}$, $\bar{6}$, $\bar{7}$, $\bar{8}$, $\bar{9}$

UNTEN (LOWER): $_1$, $_2$, $_3$, $_4$, $_5$, $_6$, $_7$, $_8$, $_9$ (Siehe auch Seite 17)

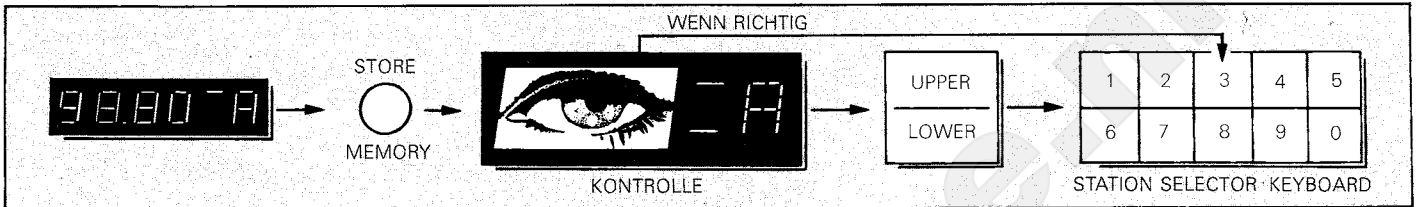

VORGEHEN BEIM SPEICHERN

BEISPIEL:

Die letzte mit dem automatischen Suchlauf gefundene Frequenz soll in den Speicher 4 OBEN ($\bar{4}$) überschrieben werden.

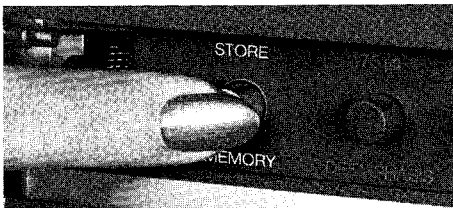

STORE MEMORY antippen

$\langle A \rangle$ blinkt

Das Blinken endet nach ca. 20 Sekunden, wenn keine Stationstaste betätigt wird.

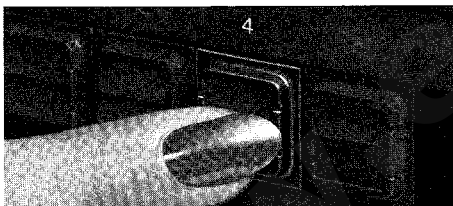

SPEICHERGRUPPE KONTROLLIEREN
STATION SELECTOR $\langle 4 \rangle$

Die Frequenz 98,80 MHz ist im Speicher $\bar{4}$ (4 OBEN) gespeichert.

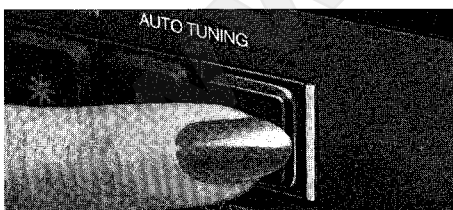
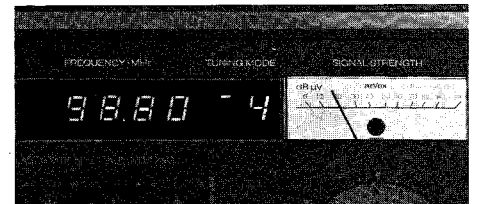

Mit dem automatischen Suchlauf wird eine weitere Station gesucht und in Speicher 2 UNTEN ($_2$) gespeichert

AUTO TUNING \uparrow

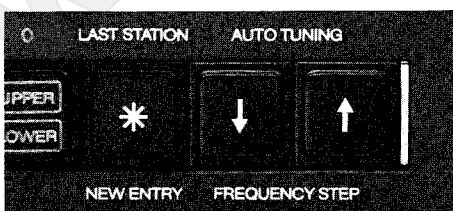
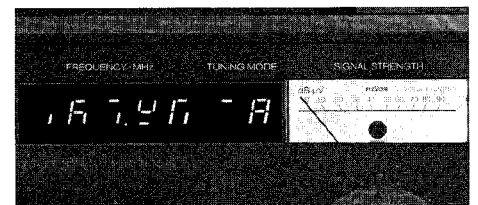

99,10 MHz

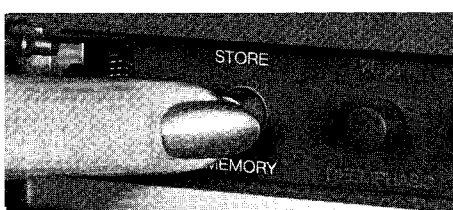
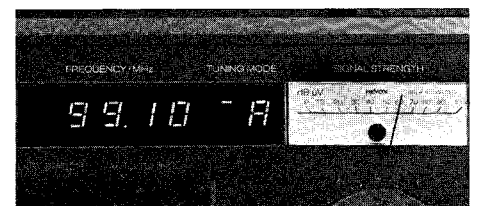

STORE MEMORY

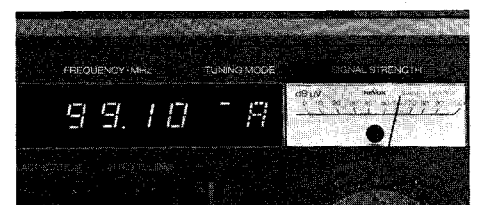

SPEICHERGRUPPE KONTROLLIEREN

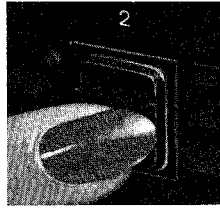
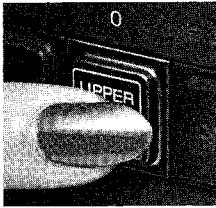

Vorwahl der Speichergruppe UNTEN (LOWER) mit Taste UPPER/LOWER

STATION SELECTOR <2>

Die Frequenz 99,10 MHz ist im Speicher _2 (2 UNTEN) gespeichert

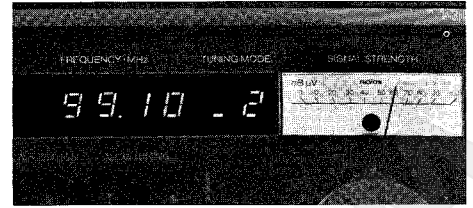

Auf diese Weise können jeder Taste 1 ... 9 des STATION SELECTOR * KEYBOARD zwei Speicherplätze (OBEN und UNTEN) zugeordnet und diese mit beliebigen Empfangsfrequenzen belegt werden. Auch Sender, die zur Zeit nicht senden, lassen sich speichern.

Bereits belegte Speicherplätze müssen bei Eingabe einer neuen Empfangsfrequenz nicht gelöscht werden.

LÖSCHEN DER SPEICHER:

Es ist möglich jeden beliebigen Stationspeicher zu löschen und eine sogenannte Leerstelle einzugeben:

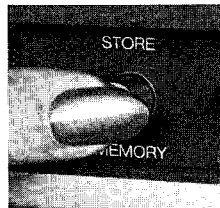
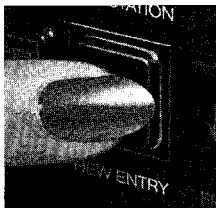

Mit CHANGE TUNING MODE auf Modus <F> umschalten; NEW ENTRY und STORE MEMORY antippen

SPEICHERGRUPPE KONTROLLIEREN

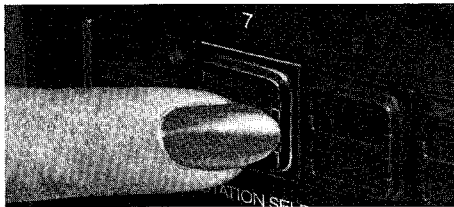
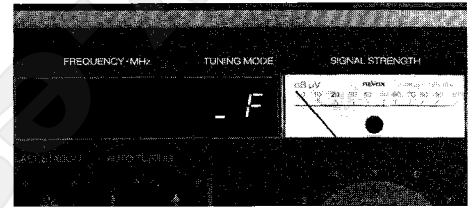

STATION SELECTOR <7>

Speicherplatz _7 (7 UNTEN) ist leer

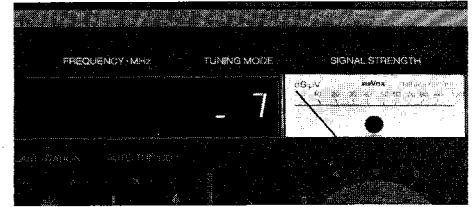

ABRUF GESPEICHERTER EMPFANGSFREQUENZEN

Die in Speicher 4 OBEN (= 4) gespeicherte Frequenz soll wieder empfangen werden ...

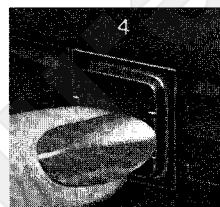
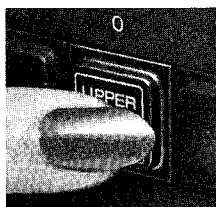

UPPER/LOWER (Kontrolle) und STATION SELECTOR <4>

98,80 MHz wird empfangen

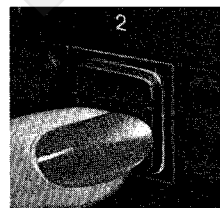
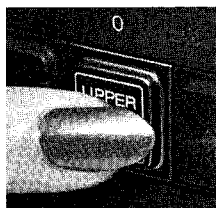

... oder die Station aus Speicher 2 UNTEN (_2)

UPPER/LOWER muss immer vor der Zahl (Speicher- nummer) gedrückt werden. Der Leucht-Balken blinkt während 20 Sekunden oder bis zum Eintasten der Speicher- nummer.

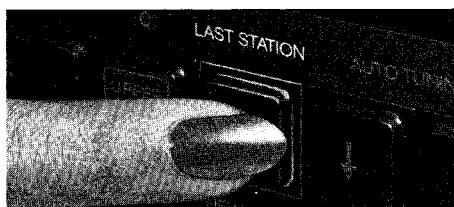
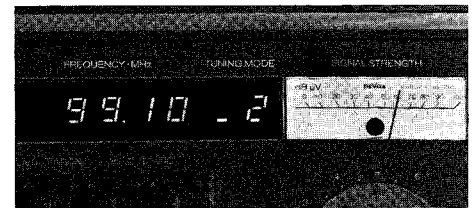

Taste LAST STATION: Diese Taste erlaubt es, jeweils die letzte mit dem automatischen Suchlauf gefundene Empfangsfrequenz wieder zu empfangen und mit dem Suchlauf fortzufahren.

Diese letzte Frequenz bleibt auch beim Ausschalten des Receivers gespeichert. Mit LAST STATION kann eine aufgefundene Frequenz bequem mit anderen, bereits gespeicherten, verglichen werden.

Ordnen der gespeicherten Frequenzen:

Eine im Speicher (A) gespeicherte Frequenz kann direkt in einen anderen Speicher (B) überschrieben werden; dabei geht allerdings eine eventuell im Speicher (B) vorhandene Frequenz verloren, Vorgehen: Frequenz (A) abrufen, STORE MEMORY antippen und neuen Speicherplatz wählen.

UNBEABSICHTIGTES LÖSCHEN:

Frequenzen und Speicherplätze notieren! Siehe Tabelle auf Titelblatt

EINTIPPEN EINER BEKANNTEN SENDEFREQUENZ

Eine beliebige, beispielsweise aus dem Programmheft bekannte, Sendefrequenz kann direkt eingetippt werden. Dazu muss auf Frequenz-Eingabe (TUNING MODE <F>) umgeschaltet werden.

Beispiel: Die Sendefrequenz ist 98,50 MHz

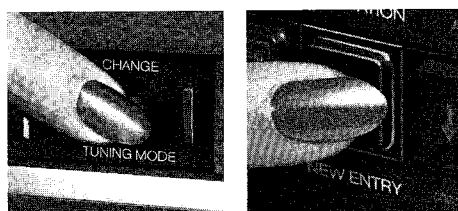

CHANGE TUNING MODE und NEW ENTRY antippen

Beim Antippen von NEW ENTRY wird die Frequenzanzeige dunkel; der Empfangsteil ist stummgeschaltet.

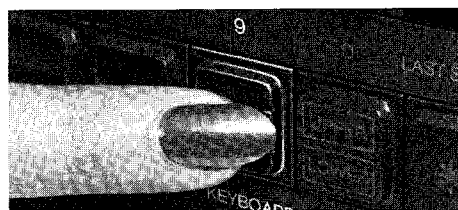

9

Der Dezimalpunkt erscheint automatisch

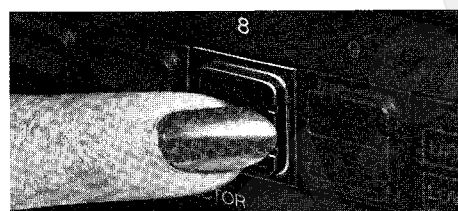
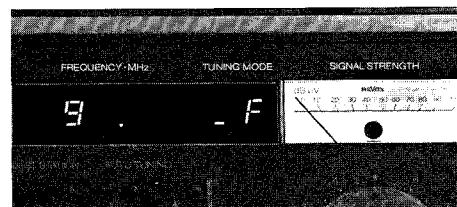

8

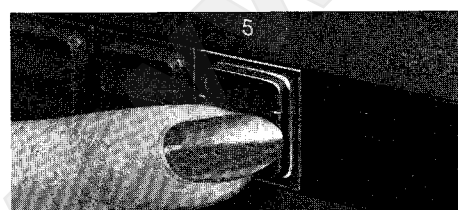
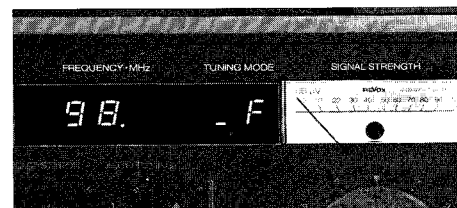

5

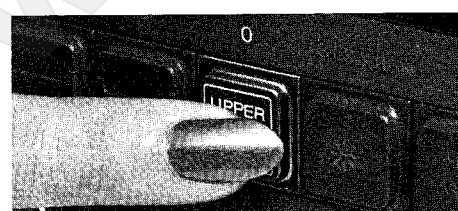
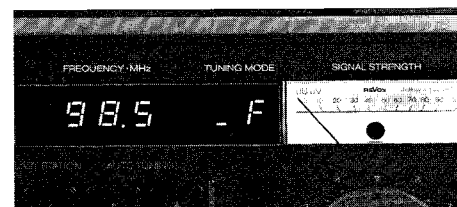

0

Bei Sendern, die im 25 kHz-Kanalraaster liegen, wird bis zur zweitletzten Ziffer eingetastet.

Beispiel 89,125 MHz: 89,12

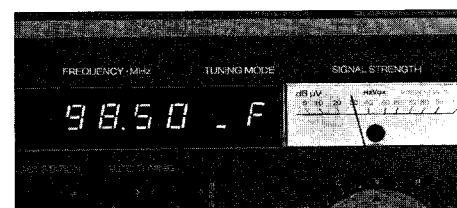

Nach dem Antippen der letzten Zahl schaltet der Tuner auf Empfang.

Der Zeiger des Instruments SIGNAL STRENGTH zeigt Vorhandensein und Stärke des Empfangssignals an.

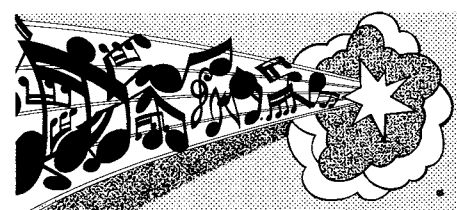

Bei Übereinstimmung der eingestellten mit der empfangenen Frequenz steht der Zeiger des Instruments TUNING im ausgesparten Mittelfeld.

Abweichungen: 20 kHz pro mm (0,04 inches) Zeiger-Ausschlag

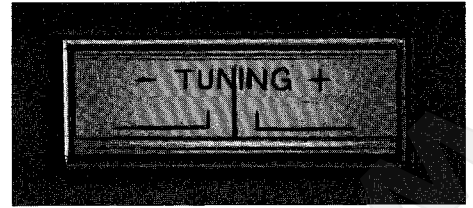

Fehler beim Eintasten:

Bei Eingaben, die ausserhalb des Empfangsbereichs oder nicht im 25 kHz-Kanalraster liegen, blinkt jeweils die zuletzt eingegebene Zahl. Beispiel: 87,40 MHz.

Eintasten der gültigen Zahl bringt die blinkende Zahl zum Verschwinden.

Korrekturen:

Bei Fehlern muss NEW ENTRY angetippt und die Eingabe neu begonnen werden.

Blinkende Frequenzanzeige:

Stummschaltung MUTING ist aktiv.

Gründe: kein Sender, zu schwaches Signal, Schaltschwelle THRESHOLD STATION zu hoch eingestellt oder Mono-Empfang mit gedrückter Taste STEREO ONLY.

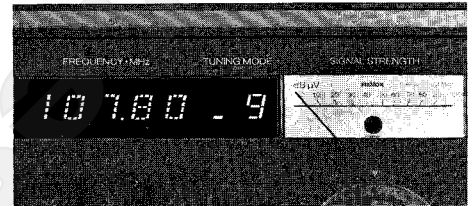
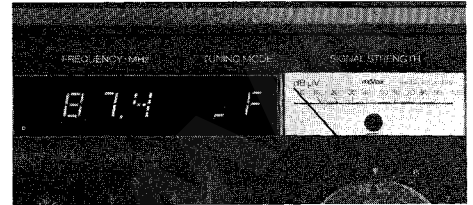

Aufheben des Blinkens:



STEREO ONLY auslösen

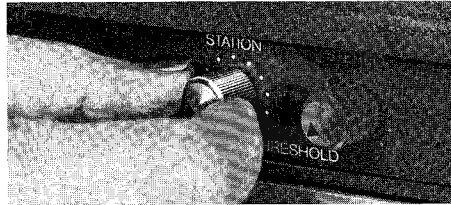

oder THRESHOLD STATION an Anschlag links

Schaltschwelle: 2 ... 20 µV an 75 Ohm

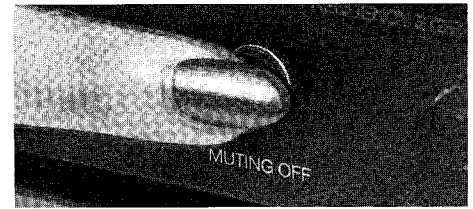

oder MUTING OFF drücken

Grenzempfindlichkeit 0,7 µV gemessen am 75 Ohm-Eingang für S/N = 26 dB bezogen auf 40 kHz Hub.

STEREO-EMPFANG

Eintippen einer weiteren Frequenz, beispielsweise ein Stereosender mit 102,40 MHz

Auf Abstimm-Art <F> umschalten

NEW ENTRY

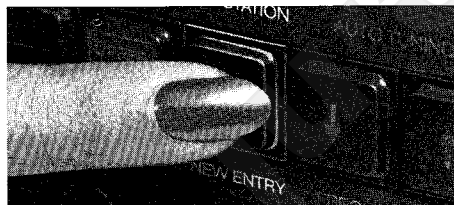

STATION SELECTOR
1, 0, 2, 4, 0

Die neue Frequenz wird empfangen.

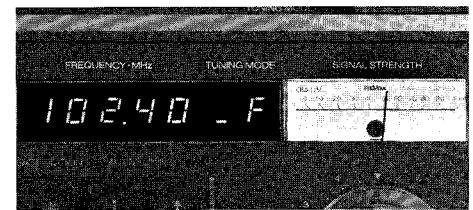

Dazu leuchtet die Stereo-Anzeige FM STEREO auf.

Für sauberen, rauschfreien Stereo-Empfang wird, systembedingt, ein ca. 20 dB (10x) höheres Empfangssignal benötigt als für gleich rauschfreien Mono-Empfang. Verrauschter Stereo-Empfang deutet meistens auf ein ungenügend starkes Empfangssignal hin.

Nutzbare Empfindlichkeit:

Mono: 2 µV; Stereo: 20 µV
gemessen am 75-Ohm-Eingang für einen Signal-/Rauschabstand von 46 dB bezogen auf 40 kHz Hub

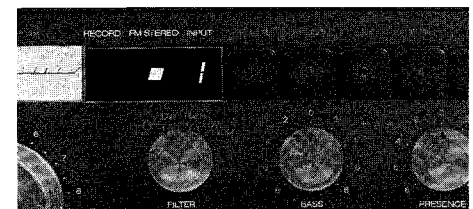

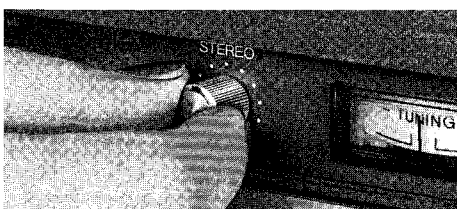

THRESHOLD STEREO

Damit lässt sich die Umschaltsschwelle Mono/Stereo so einstellen, dass nur Stereosender genügender Qualität stereophon empfangen werden.

Umschaltsschwelle 5 ... 500 μ V an 75 Ohm



HIGH BLEND

Bei schwachen, leicht verrauschten, Stereosendern wird das Empfangsrauschen vermindert.

Die Übersprechdämpfung zwischen den Stereokanälen wird reduziert. Damit wird, bei gleichbleibendem Übertragungsbereich, das Empfangsrauschen um 7 dB reduziert (bei 50 μ V an 75 Ohm)
Übersprechdämpfung (Taste HIGH BLEND ausgelöst): 42 dB bei 1 kHz, 40 kHz Hub und 1 mV an 75 Ohm Antennenspannung. Übersprechdämpfung (Taste HIGH BLEND gedrückt): 10 dB



FM MONO

Kanaltrennung wird aufgehoben. Bei stark verrauschten Stereosendern wird das Empfangsrauschen vermindert.

Diese Taste hat keinen Einfluss auf die Stereowiedergabe des Verstärkerteils.



STEREO ONLY

Nur Stereosender werden empfangen, Monosender sind stummgeschaltet (Blinken der Frequenzanzeige)
Einstellen der Empfangsschwelle mit THRESHOLD STEREO

Schwache Stereosender, deren Empfangssignal unter der eingestellten Schaltschwelle TRESHOLD STATION liegen, werden auch stummgeschaltet.

Pilotton- und Hilfsträgerdämpfung:

70 dB, (inkl. Oberwellen) 15 kHz ... 300 kHz
linear, bezogen auf 75 kHz Hub gemessen mit
1 mV an 75 Ohm Antennenspannung

Mit dem automatischen Suchlauf und gedrückter Taste STEREO ONLY lassen sich bequem alle Stereosender mit einstellbarer, minimaler Signalstärke feststellen:



STEREO ONLY drücken

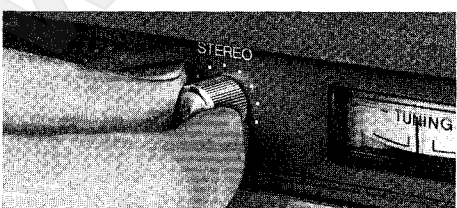

TRESHOLD STEREO einstellen

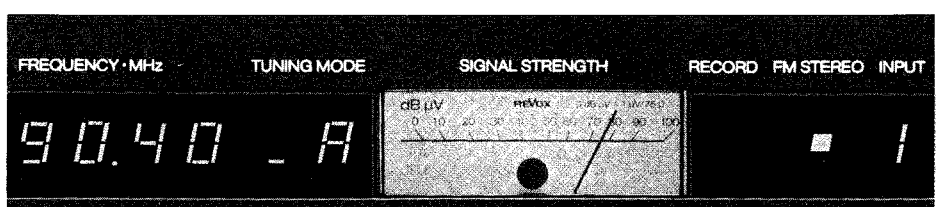
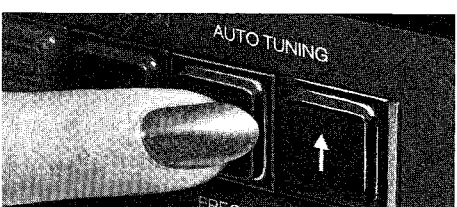

MANUELLER SUCHLAUF

Der ganze Empfangsbereich kann in 25 kHz-Schritten von Hand abgetastet werden. Dies ist besonders praktisch, wenn Stationen, deren Frequenz nur ungefähr bekannt ist, eingestellt werden sollen (oder um mit dem automatischen Suchlauf gefundene Stationen im 25 kHz-Raster – beispielsweise 89,125 MHz – exakt abzustimmen).

Beispiel: Es soll eine Station knapp unter 90 MHz exakt eingestellt werden:

90,00 MHz eintasten

Abstimm-Art (F), NEW ENTRY, 9000

Die Anzeige blinkt, da kein Sender empfangen wird.

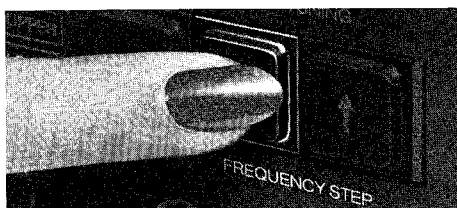
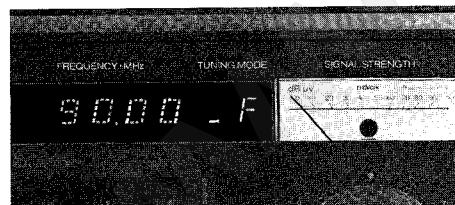

FREQUENCY STEP ↓

Das Instrument SIGNAL STRENGTH zeigt schwaches Signal an

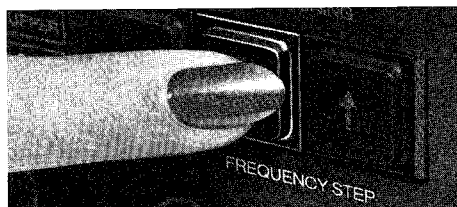
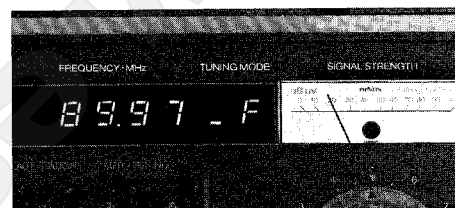

FREQUENCY STEP ↓

Der Zeigerausschlag SIGNAL STRENGTH wird grösser

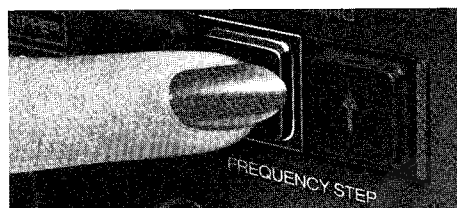
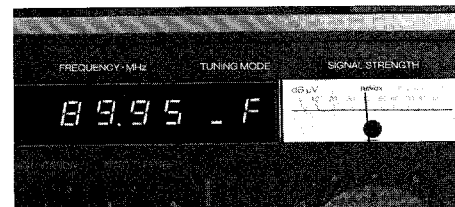

FREQUENCY STEP ↓

.....usw. Wie bei einem Empfänger mit Drehknopf kann die Sendefrequenz unter Beobachtung der Abstimminstrumente TUNING und SIGNAL STRENGTH exakt eingestellt werden.

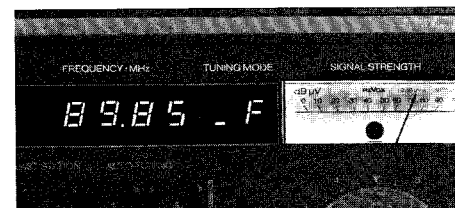

Der Zeiger des Instruments TUNING muss im ausgesparten Mittelfeld stehen.

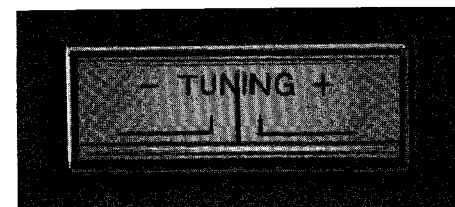

Dauerndes Betätigen der FREQUENCY STEP – Tasten bewirkt Schnellauf wie beim automatischen Suchlauf. Stoppt sofort beim Loslassen.

RAUSCHVERMINDERUNG

nur bei eingeschobenem DOLBY® -Rauschunterdrückungssystem wirksam

Einbau ohne Abgleicharbeiten nach Entfernen der linken Seitenwand und des Blindprints

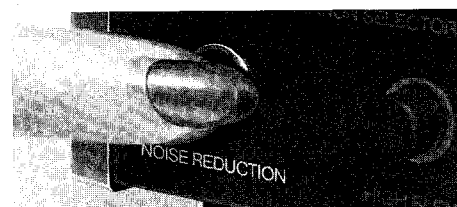

NOISE REDUCTION

Die Lampe im Zentrum des Instruments SIGNAL STRENGTH leuchtet.

Diese Taste sollte nur bei dolbysierten Sendungen gedrückt werden, da sonst unerwünschte Frequenzgangfehler auftreten.



BEDIENUNGSANLEITUNG VERSTÄRKERTEIL



WAHL DER SIGNALQUELLEN/ EINGANGSWAHL

Die Eingangswahltasten 1 ... 5 haben eine Doppelfunktion: Durchschalten des Empfangsteils und der Audio-Eingänge auf den Verstärker oder auf die Tonbandausgänge. Die gewählten Signalquellen bleiben beim Ausschalten gespeichert.

VERSTÄRKERTEIL:

Die Anzeige INPUT zeigt die abzuhörende Signalquelle.

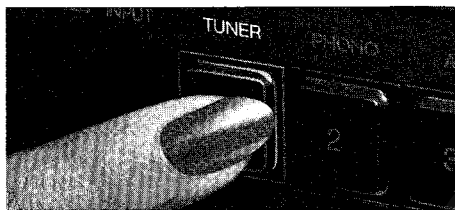

TUNER Empfangsteil

NF-Ausgang Tuner:
15 kHz Hub/400 Hz ergibt 70 W an 8 Ohm
am Ausgang SPEAKERS A, B
Fremdspannungsabstand:
75 dB, 30 Hz ... 15 kHz linear, gemessen bei
1 mV an 75 Ohm, Antennenspannung bezogen auf
75 kHz Hub.

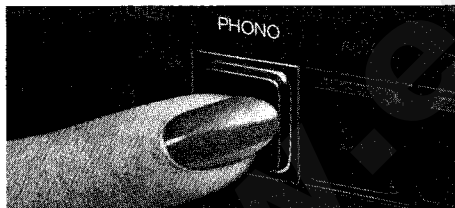
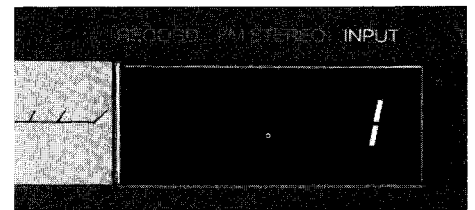

PHONO Plattenspieler

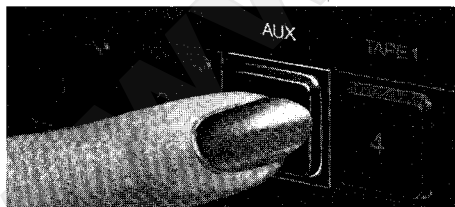
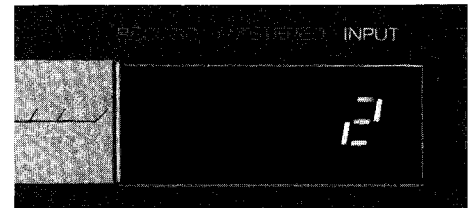

AUX Hilfeingang für MW/LW/KW-Radios etc.

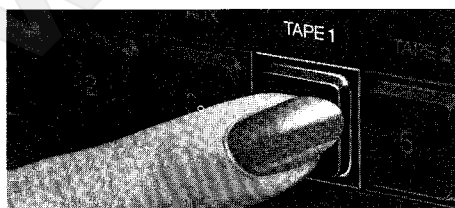
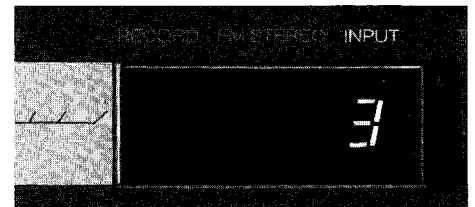

TAPE 1 Tonband 1

Wiedergabe

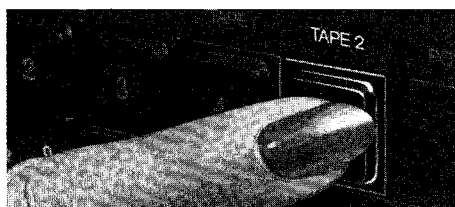
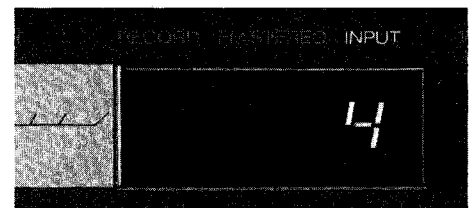

TAPE 2 Tonband 2

Wiedergabe

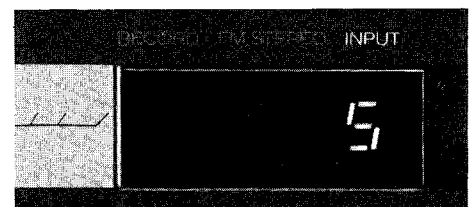

TONBANDAUFNAHMEN

Die Anzeige RECORD zeigt die Signalquelle (1 ... 5), die über die beiden Tonbandausgänge TAPE 1 OUTPUT (Cinch) und TAPE 2 OUT (DIN) auf die Tonbandgeräte geschaltet ist. Die Wahl der Aufnahme-Signalquelle erfolgt unabhängig des abgehörten Einganges (Anzeige INPUT).

Beispiel: Ab Empfangsteil soll eine Tonbandaufnahme gemacht werden.

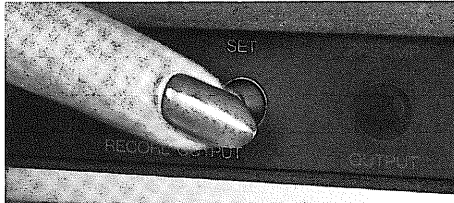

RECORD OUTPUT SET

In der Anzeige RECORD blinkt der untere Balken oder die zuletzt angezeigte Zahl

Wird innerhalb 20 Sekunden keine weitere Taste betätigt, hört das Blinken auf.

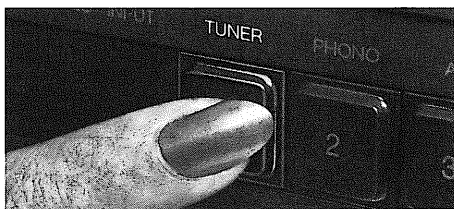

TUNER

In der Anzeige RECORD leuchtet die Zahl 1

Jetzt kann beispielsweise ein UKW-Programm auf Tonband 1 aufgenommen werden, während ein Programm vom Tonbandgerät 2 abgehört wird.



Ausnahmen: Eingang TAPE 1 (4) wird nur auf Tonbandausgang TAPE 2, Eingang TAPE 2 (5) wird nur auf Tonbandausgang TAPE 1 durchgeschaltet (Rückkopplungsmöglichkeit). Während dem automatischen Suchlauf des Empfangsteils ist ein Umschalten nicht möglich.

Ausgangsspannungen:
TAPE 1 (Cinch): 135 mV/R_L min. 47 kOhm, TAPE 2 (DIN): 5,5 mV/R_L 10 kOhm
NF-Ausgangsspannung Tuner: 75 kHz Hub/400 Hz ergibt 0,7 V an TAPE 1.

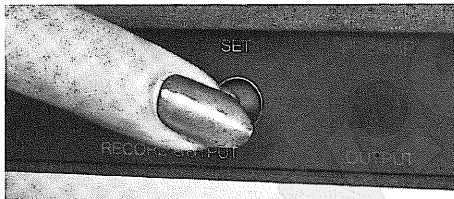

Löschen (Stummschalten) der Tonbandausgänge:

RECORD OUTPUT SET

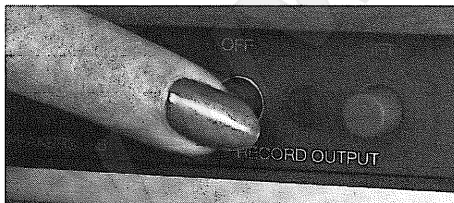

RECORD OUTPUT OFF

Die TAPE-Ausgänge können bei Nichtgebrauch stummgeschaltet werden



WEITERE AUSGÄNGE: PREAMP OUTPUT

Jack-Anschluss (Stereo)
Vorverstärker-Ausgang

Ausgangsspannung 0,85 V/R_L min. = 47 kOhm

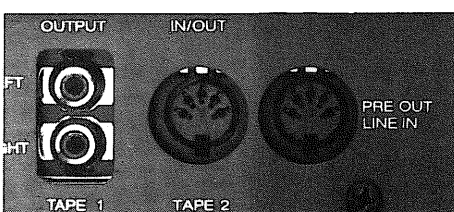

PRE OUT DIN-Anschluss (Stereo)

Ausgangsspannung 0,85 V/R_L min. = 10 kOhm

LINE IN Ausgangsvorverstärker-Eingang

1 V/50 kOhm

Achtung:
Beim Einstecken eines DIN-Steckers in diese Buchse wird die Verbindung Vorverstärker-Ausgangsvorverstärker aufgetrennt. An die Trennstellen (Vorverstärker-Ausgang oder Ausgangsvorverstärker-Eingang) können Filter, Equalizer etc. eingeschleift werden.

KLANGREGLER / FILTER



KLANGREGELUNG

Die Klangregler wirken auf beide Kanäle gemeinsam

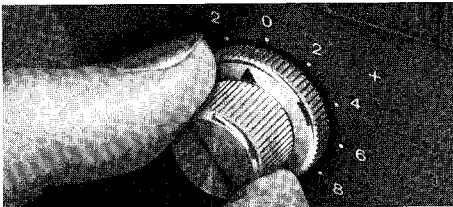

BASS Bassregler

± 8 dB bei 120 Hz

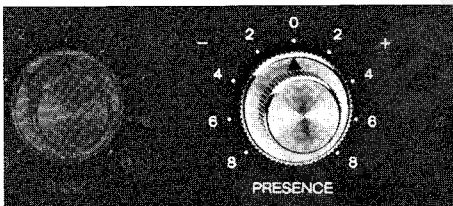

PRESENCE Präsenzregler (mittlerer Tonbereich)

± 8 dB bei 3 kHz

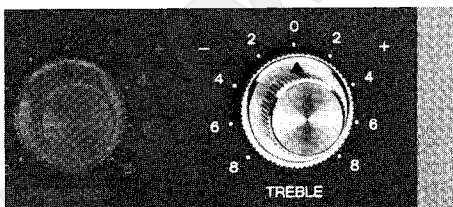

TREBLE Höhenregler

± 8 dB bei 8 kHz

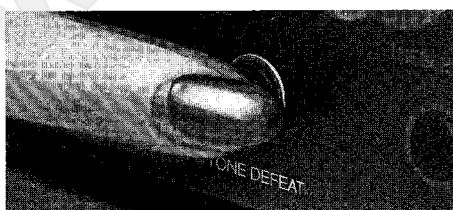

TONE DEFEAT

Die Klangregler werden überbrückt,
linearer Frequenzgang

Die Filter LOW/HIGH werden nicht überbrückt.

FILTER

Die Filter wirken auf beide Kanäle gemeinsam
Stellung LOW: Rumpelfilter, Absenkung tiefer Frequenzen
Stellung HIGH: Höhenfilter, Rauschfilter, Absenkung hoher Frequenzen
Stellung LOW/HIGH: Rumpelfilter und Höhenfilter wirksam



LOW

50 Hz, -3 dB (12 dB/Oktave)

HIGH

8 kHz, -3 dB (12 dB/Oktave)

WEITERE FUNKTIONEN DES VERSTÄRKERTEILS

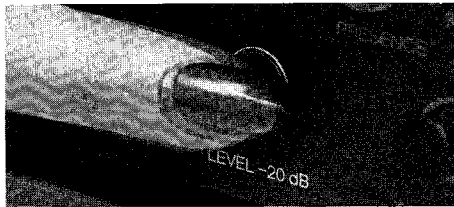

LEVEL -20 dB

Lautstärkereduktion um 20 dB. Die Lautstärke wird auf 25% der eingestellten Lautstärke linear reduziert.

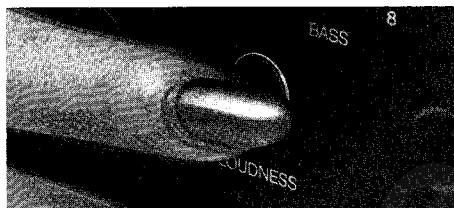

LOUDNESS

Gehörriichtige Lautstärkeregelung

bei -40 dB (ca. Stellung «4»): 100 Hz + 5 dB,
10 kHz + 6 dB

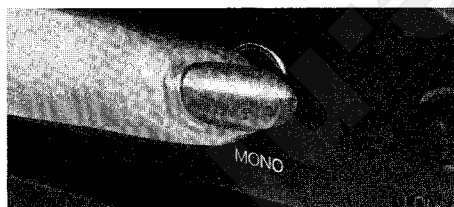

MONO

Monaurale Wiedergabe.

Linker und rechter Kanal des Verstärkerteils werden zusammengeschaltet. Die Tonbandausgänge werden davon nicht berührt.

Es kann also eine Signalquelle (beispielsweise AUX) monaural abgehört und gleichzeitig eine Stereosendung auf Tonband aufgezeichnet werden.

**ZUSÄTZLICHE
TECHNISCHE DATEN**

Harmonische Verzerrungen (1 kHz):	<0.02% bei 2 V Ausgangsspannung
Frequenzgang:	+ 0/-0.7 dB, 20 Hz ... 20 kHz
Bestückung:	100 Transistoren, 77 Dioden, 19 Abstimm-Doppeldioden, 45 IC, 1 Mikrocomputer 4K x 8 Bit, 3 Brückengleichrichter, 9 Sieben-Segment-Anzeigen
Gewicht (Masse):	ca. 13 kg
Abmessungen (B x H x T):	452 x 151 x 350 mm

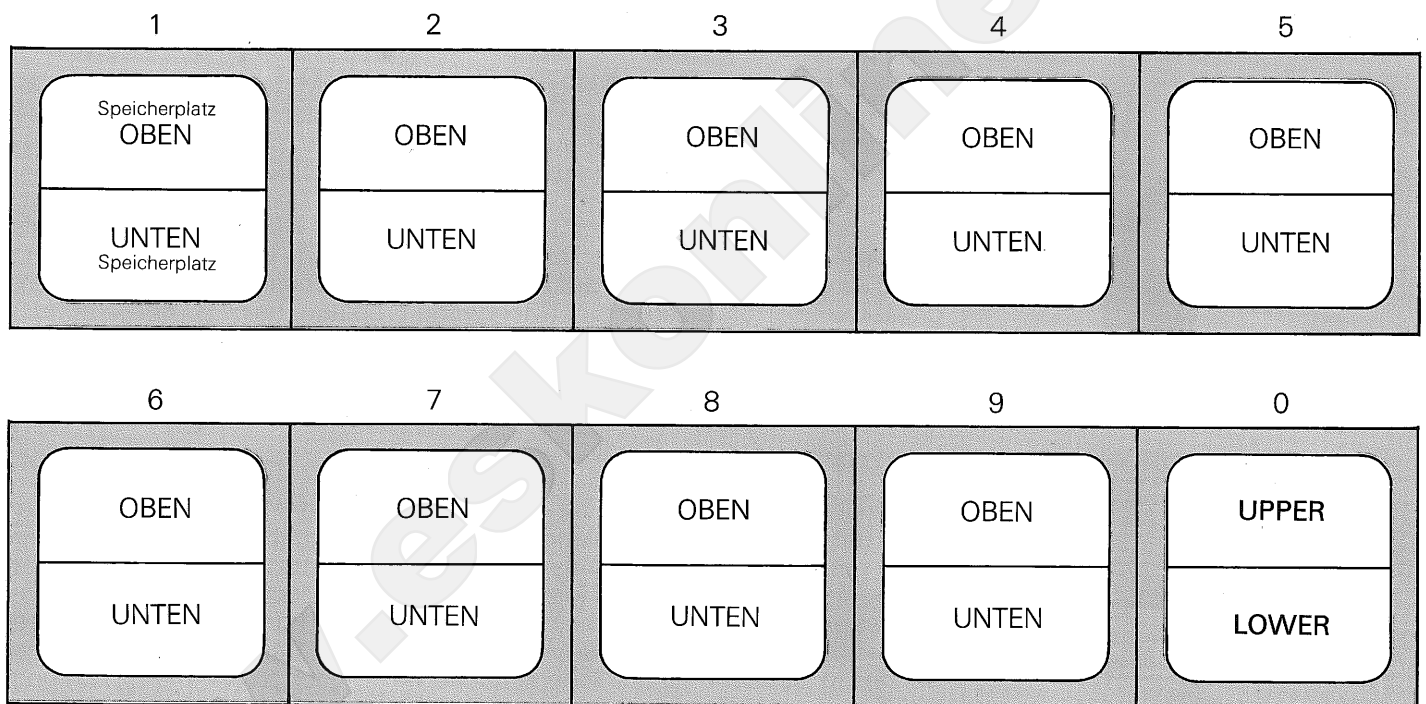

ORGANISATION DER STATIONSSPEICHER

VORWAHL

GARANTIE

Den Geräten, welche in Belgien, Bundesrepublik Deutschland, Österreich und Frankreich verkauft werden, liegt eine spezielle Garantieforderungskarte bei. Entweder befindet sich die Karte in der Verpackung oder in einer Plastiktasche an der Verpackungs-Aussenseite. Sollte die Karte fehlen, wenden Sie sich an Ihr REVOX-Fachgeschäft oder an Ihre REVOX-Landesvertretung.

Füllen Sie Ihre Garantieforderungskarte aus, und senden Sie diese an die REVOX-Vertretung des Verkaufslandes.

Für in der Schweiz gekaufte Geräte gibt der Fachhändler die Garantiebescheinigung ab. Bitte beachten Sie, dass die Garantie nur im Verkaufsland gültig ist. Ausserdem machen wir Sie darauf aufmerksam, dass die Garantie erlischt, wenn am Gerät unsachgemässe Eingriffe oder nicht fachmännische Reparaturen vorgenommen worden sind.

UKW-ANTENNEN

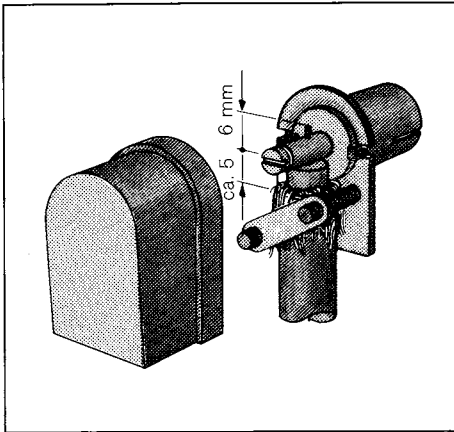

Um den hohen Qualitätsstandard des B780 optimal nutzen zu können, muss durch den Anschluss einer leistungsfähigen Antennenanlage eine ausreichend grosse Eingangsspannung erzielt werden.

Den Idealfall stellt eine drehbare Aussenantenne mit guter Richtcharakteristik und möglichst hohem Antennengewinn dar. Mit der (als Option erhältlichen) Antennenrotorsteuerung lässt sich für jede programmierte Station die Antennenstellung speichern. Vielfach steht eine Gemeinschafts-Antennenanlage zur Verfügung, die UKW-Signale ausreichender Qualität liefert.

Besteht keine Möglichkeit, den B780 an eine Aussen- oder Gemeinschaftsantenne anzuschliessen, kann eine gute Zimmerantenne angeschlossen werden. Allerdings können Zimmerantennen nur Behelfsantennen sein, da sie wegen ihrer kleinen Abmessungen geringe Antennengewinne haben und die ankommenden Wellen durch die moderne Stahl-Beton-Bauweise stark gedämpft werden. Auch ist der Störpegel innerhalb des Hauses meist grösser als ausserhalb. Doch lässt sich, bis einige Kilometer vom Sender entfernt, bei geeigneter Aufstellung auch mit einer Zimmerantenne ein brauchbarer Empfang erzielen.

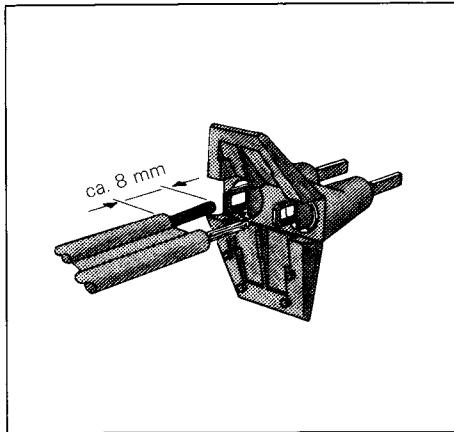

Im UKW-Bereich mit Wellenlängen von ungefähr 3 Metern ist die Wellenausbreitung ähnlich der Ausbreitung von Licht. Die besten Empfangsergebnisse sind demnach bei Direktsicht auf die Sendeantenne zu erwarten. Mit geeigneten Antennen ist Empfang auch hinter dem optischen Horizont möglich.

Meterwellen werden an festen Gegenständen, deren Ausdehnung grösser als die Wellenlänge ist, reflektiert. Treffen solche reflektierte Wellen zusammen mit direkt empfangenen Wellen auf die Antenne, entstehen im Empfänger unangenehme Laufzeitverzerrungen (Mehrwege-Empfang, beim Fernsehempfang als Geisterbilder bekannt). Laufzeitverzerrungen können durch Einsatz und präzise Ausrichtung guter Richtantennen eliminiert werden.

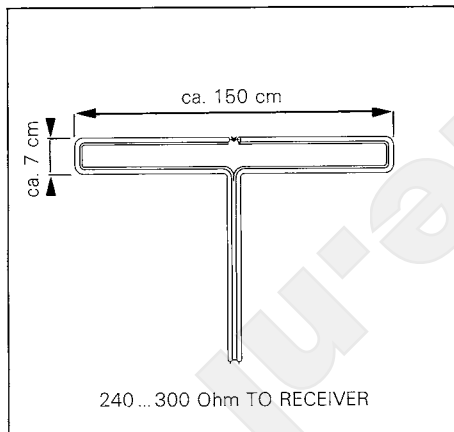

Falls keine andere Antenne zur Verfügung steht, oder für Versuchszwecke, kann mit wenig Arbeitsaufwand aus 240-Ohm-Flachkabel eine Behelfsantenne gebaut werden. Allerdings muss nochmals daran erinnert werden, dass solche Antennen immer den letzten Ausweg darstellen sollen, wenn ein Anschluss an eine Aussenantenne nicht möglich ist. Sie kommen normalerweise nur bei überdurchschnittlichen Feldstärken und mit Beschränkung auf nahe Sender in Betracht. Eine solche Antenne muss quer zur Empfangsrichtung montiert werden.

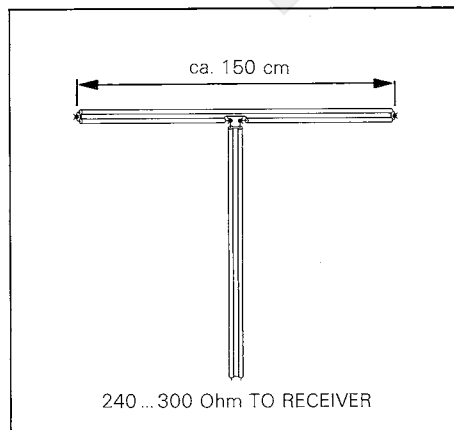

MESSUNG DER LAFZEITVERZERRUNGEN MIT DEM OSZILLOSKOP

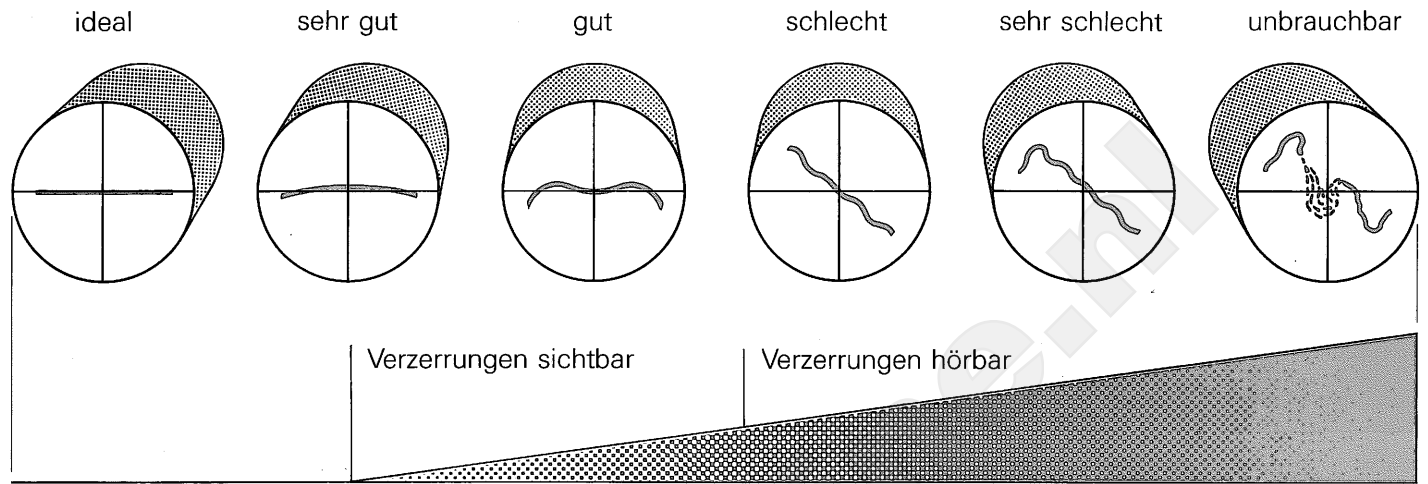

MESSUNG VON HUB UND SIGNALSTÄRKE

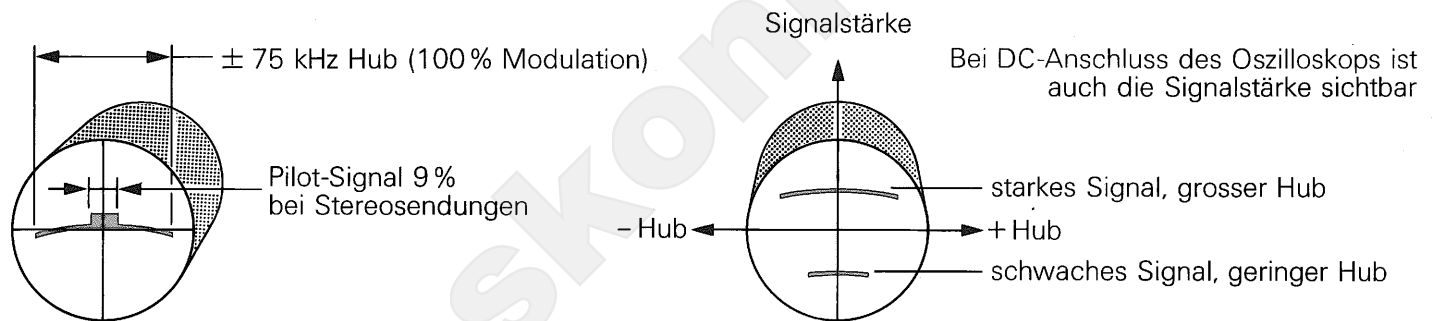

ENTSTEHUNG VON MEHRWEGE-EMPFANG, MESSANORDNUNG

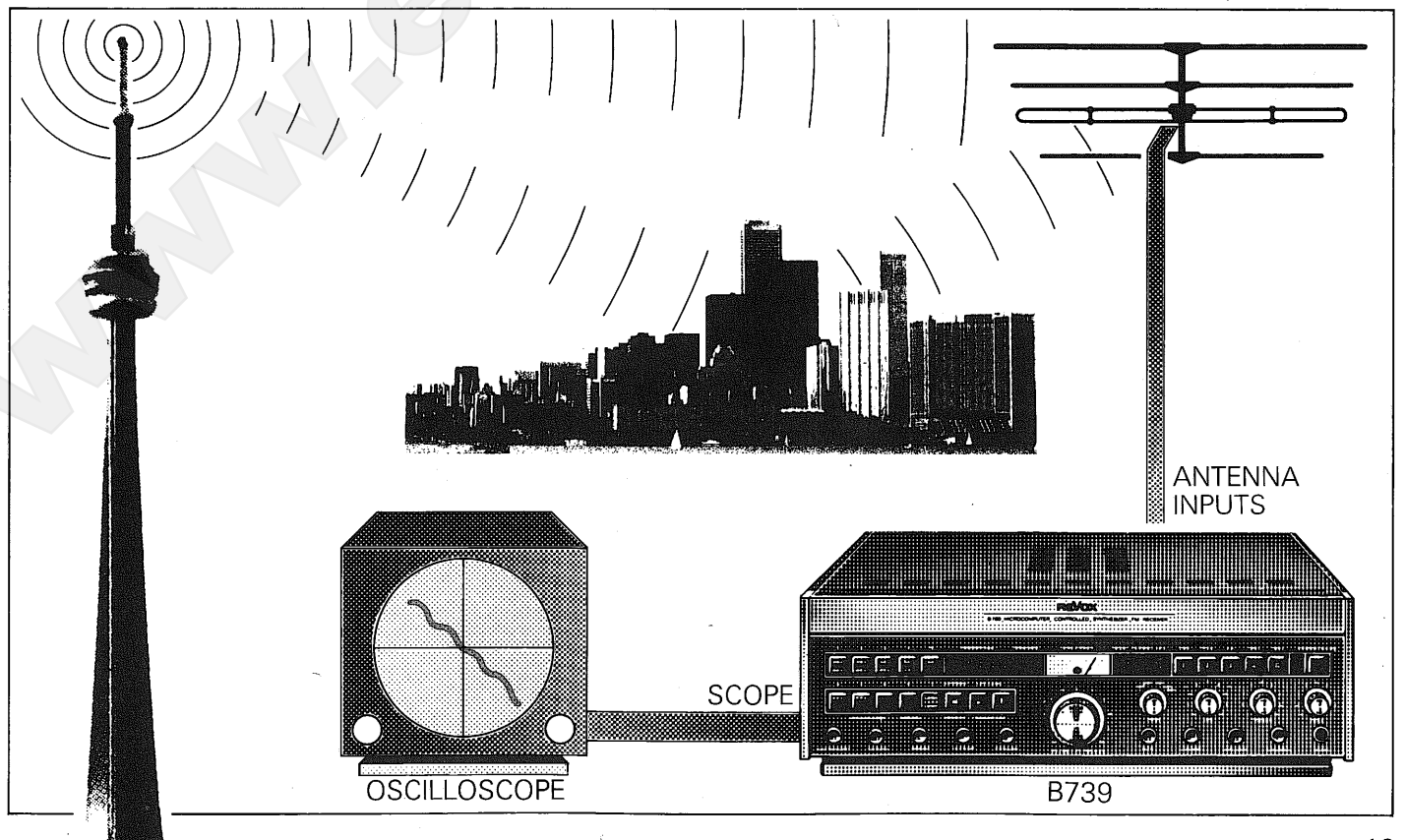

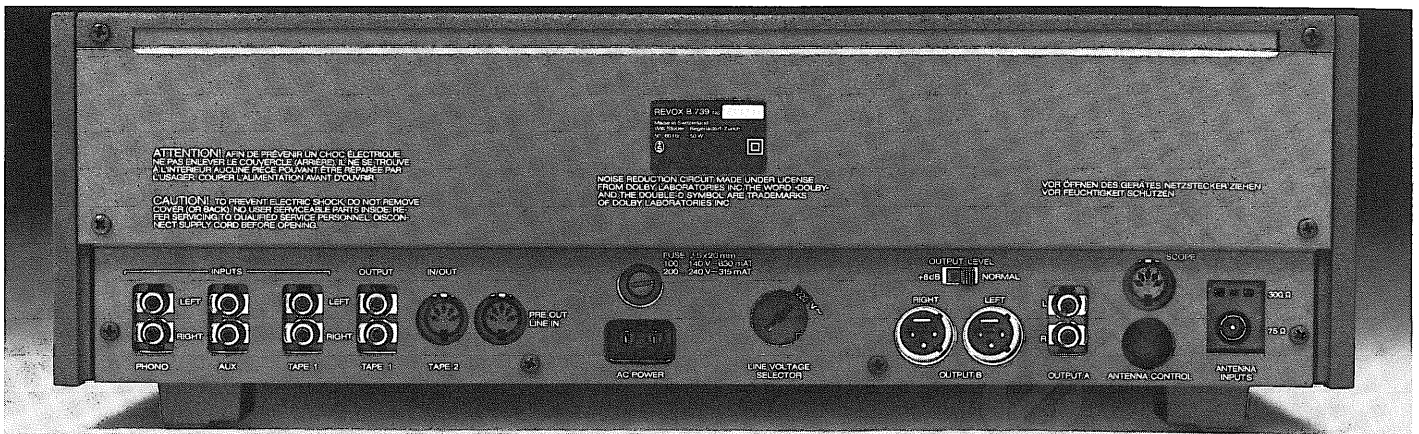

STECKERBELEGUNGEN

JACK PREAMP OUT
0,85 V/R_L min. 47 kOhm

JACK PHONES
11,8 V / optimale Last 200 ... 800 Ohm



XLR

OUTPUT A
2 V/220 Ohm

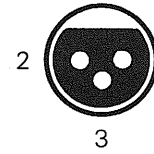

1 Gehäuse
2 Masse (0V)
3 Signal

DIN TAPE 2 IN/OUT

IN: 150 mV/50 kOhm
OUT: 5,5 mV/R_L min. 10 kOhm

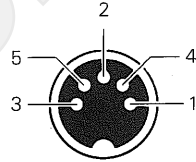

1 Ausgang links
2 Masse, Abschirmung
3 Eingang links
4 Ausgang rechts
5 Eingang rechts

DIN PRE OUT/LINE IN

OUT: 0,85 V/R_L min. 10 kOhm
IN: 1 V/50 kOhm

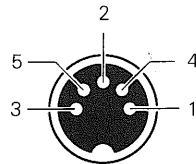

1 PRE links
2 Masse, Abschirmung
3 LINE links
4 PRE rechts
5 LINE rechts

DIN SCOPE

Oszilloskopausgang:
vertikal (Y): 50 mV an 75 Ohm HF \pm 1V
horizontal (X): 75 kHz Hub \pm 2,8 V_{SS}
Buchse nach DIN 41524

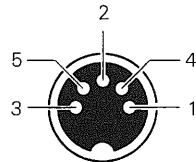

1 X Achse
2 Masse
3 Y Achse
4 Fernschaltung
5 Fernschaltung Option

VERBINDUNGSKABEL

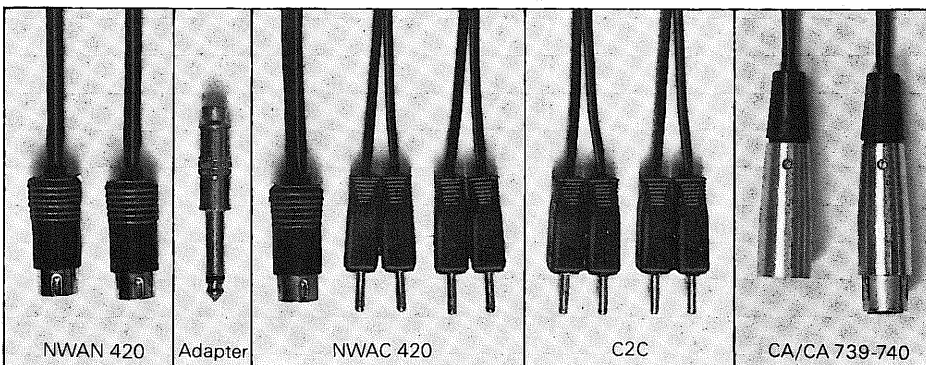

- NWAN 420, 2m, beidseitig 5 Pol DIN Aufnahme/Wiedergabe Stereo Art. Nr. 33092
- Adapter Cinch-Kupplung/Jackstecker Art. Nr. 33405
- NWAC 420, 2m, 2 x Doppelcinch-DIN Aufnahme/Wiedergabe stereo Art. Nr. 33082
- C2C 210, 1m, beidseitig Doppelcinch 2-Kanal-Verbindung, Art. Nr. 33041
- C2C 220, 2m, beidseitig Doppelcinch 2 Kanalverbindung, Art. Nr. 33042
- CA/CA 739-740 1m, beidseitig Cannon (XLR) 1 Kanalverbindung Art. Nr. 33211

MODE D'EMPLOI REVOX B739

EMBALLAGE

Veillez conserver l'emballage original.
En cas de transport, il est la meilleure protection de votre appareil.

AVIS IMPORTANTS

Protégez votre appareil d'un excès de chaleur et d'humidité. Placez-le de manière à ne pas obstruer les fentes d'aération. Il est impératif de retirer la fiche secteur avant toute intervention à l'intérieur de l'appareil. Ce dernier ne doit être alimenté qu'en courant alternatif (50 ... 60 Hz). La tension peut être adaptée au réseau local, 100/120/140 volts et 200/220/240 volts, par un sélecteur de tension.

STATION	FRÉQUENCE	HAUT1		2			3
STATION	FRÉQUENCE	BAS1		2			3
		4		5			6
		4		5			6
		7		8			9
		7		8			9

Printed in Switzerland
by WILLI STUDER 18.631.980
Copyright by WILLI STUDER
CH-8105 Regensdorf-Zurich

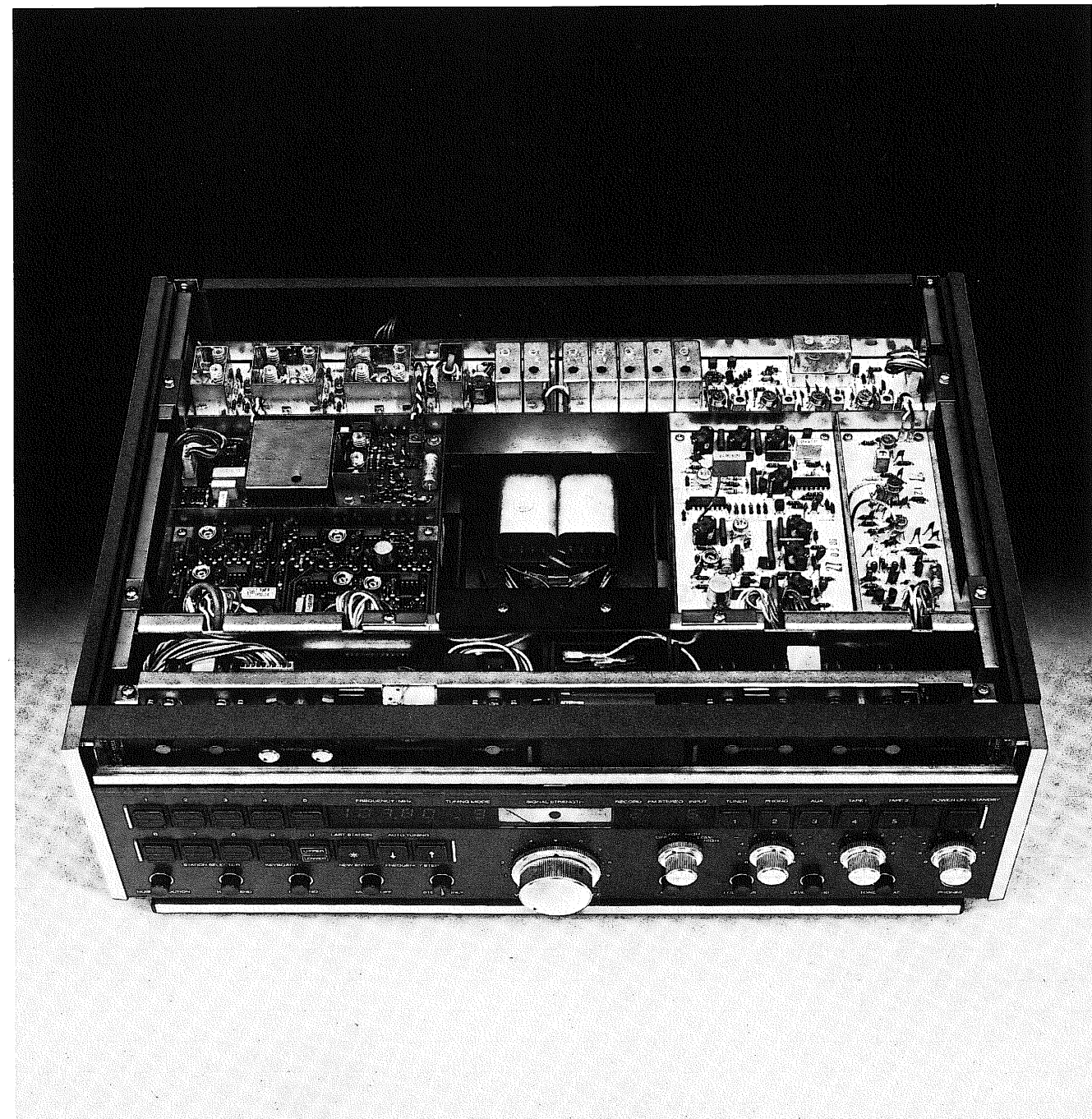

Veillez déplier la page

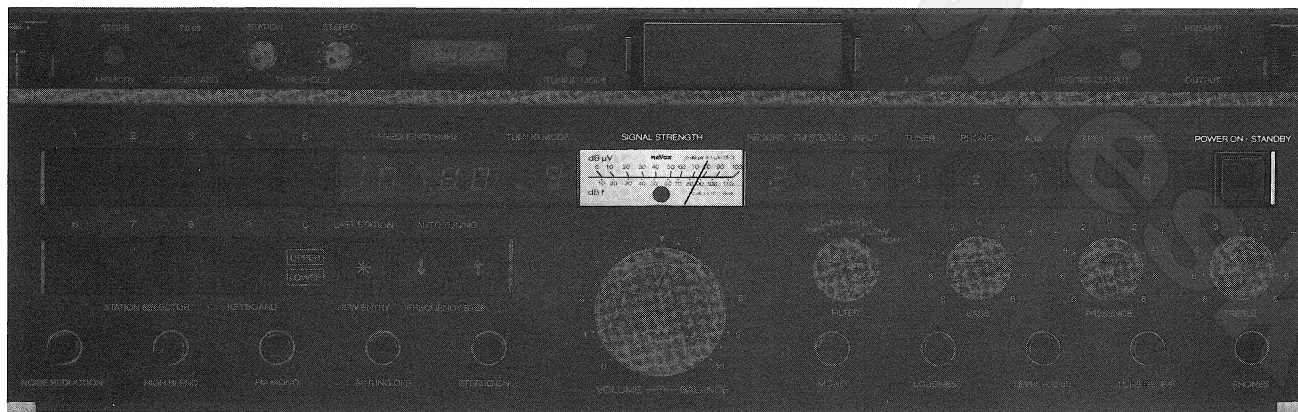

ENCLANCHEMENT, ALIMENTATION, ACCUMULATEURS POUR LA MÉMOIRE DES STATIONS



RÉCEPTEUR, MÉMOIRE DES STATIONS, RECHERCHE AUTOMATIQUE



SÉLECTION DES ENTRÉES, CHOIX DES SORTIES, SORTIE FRONTALE

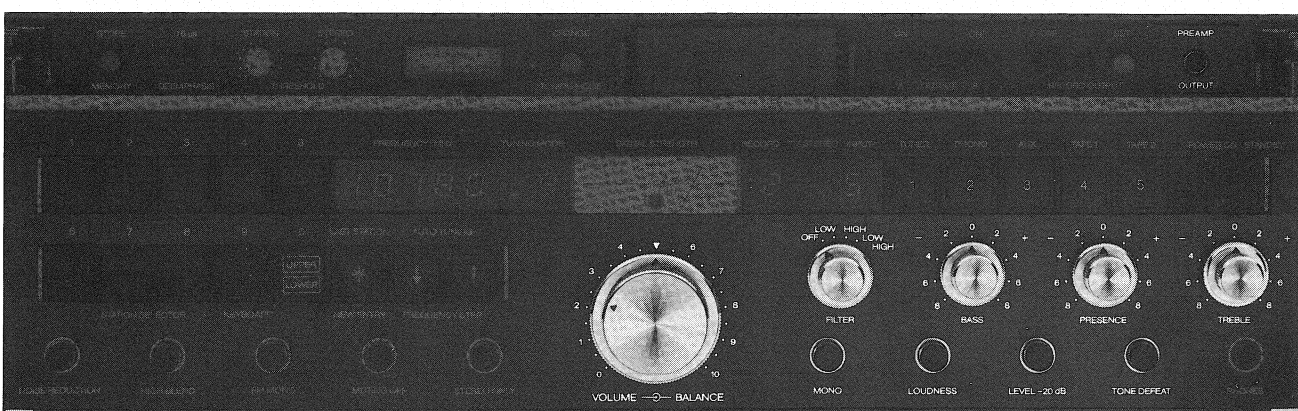

VOLUME, BALANCE, CONTRÔLE DE TONALITÉ, FILTRES

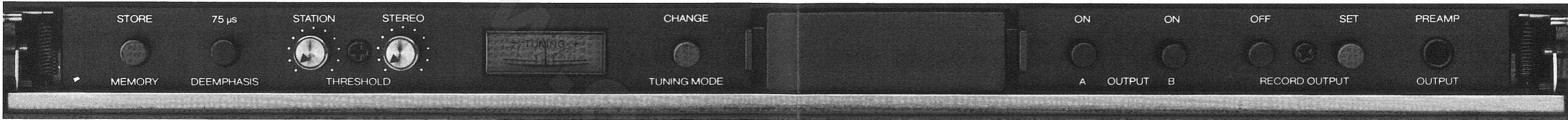

MISE EN MÉMOIRE

DÉSACCENTUATION DE 75 MICRO-SECONDES

SEUIL D'ÉCOUTE POUR TOUTES LES STATIONS

SEUIL D'ÉCOUTE POUR LES STATIONS STÉRÉO

CENTRAGE DES STATIONS

CHANGEMENT DU MODE D'ACCORD DES STATIONS

ACCUMULATEURS

HAUT-PARLEURS GROUPE A

SORTIE

HAUT-PARLEURS GROUPE B

ANNULATION

SORTIE D'ENREGISTREMENT

PROGRAMMATION

SORTIE DU PREAMPLIFICATEUR

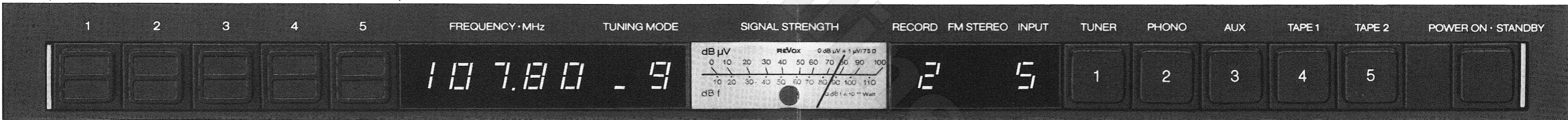

TOUCHES DE SÉLECTION DE STATION

FRÉQUENCE EN MEGAHERTZ

MODE D'ACCORD

INTENSITÉ DU SIGNAL DE RÉCEPTION

ENREGISTREMENT

RÉCEPTION STÉRÉO

ENTRÉE

RÉCEPTEUR

TABLE DE LECTURE

ENTRÉE AUXILIAIRE

MAGNÉTOPHONE 1

MAGNÉTOPHONE 2

ENCLENCHEMENT

DÉCLENCHEMENT

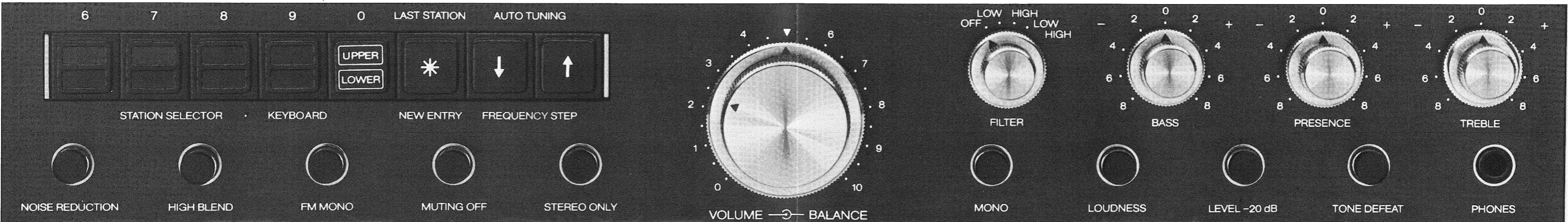

TOUCHES DE SÉLECTION DE STATION

HAUT GROUPE DE BAS MÉMOIRE

DERNIÈRE STATION NOUVELLE ENTRÉE

RECHERCHE AUTOMATIQUE

PAS DE 25 kHz

FILTRES

GRAVE

PRÉSENCE (MÉDIUM)

AIGU

RÉDUCTEUR DE BRUIT

SÉPARATION DES CANAUX

RÉCEPTION MONO

DÉCLENCHEMENT DE L'ACCORD SILENCIEUX

UNIQUEMENT LES STATIONS STÉRÉO

VOLUME

BALANCE

ÉCOUTE MONO

CORRECTION PHYSIOLOGIQUE

ATTÉNUATION DU VOLUME (25%, linéaire)

DÉCONNEXION DU CONTRÔLE DE TONALITÉ

CASQUE

AVIS

Pour vous familiariser rapidement avec les différents organes de commande du B739, nous vous conseillons de lire les pages 2 à 16 de ce mode d'emploi, en étudiant pas à pas les descriptions et en effectuant les manipulations correspondantes sur votre appareil.

RACCORDEMENT/MISE EN SERVICE

2

MODE D'EMPLOI DE L'ÉLÉMENT RÉCEPTEUR

Recherche automatique	5
Mise en mémoire des fréquences de réception	7
Appel des fréquences de réception mémorisées	8
Composition d'une fréquence connue	9
Réception stéréo	10
Recherche manuelle	12
Réduction de bruit	12

MODE D'EMPLOI DE L'ÉLÉMENT AMPLIFICATEUR

Choix des sources/sélection d'entrée	13
Enregistrement	14
Contrôle de tonalité	15
Filtres	16
Fonctions supplémentaires de l'amplificateur	16
Caractéristiques techniques	17

DIVERS

Organisation de la mémoire des stations	17
Garantie	17
Antenne OUC (FM)	18
Distorsions dues aux réceptions multiples	19
Détail des prises de raccordement	20
Câbles de raccordement REVOX	20
Interconnexions d'une installation REVOX, diagramme de fonctionnement	20

dépliant dernière page

RACCORDEMENT/MISE EN SERVICE

Abaissez le cache escamotable

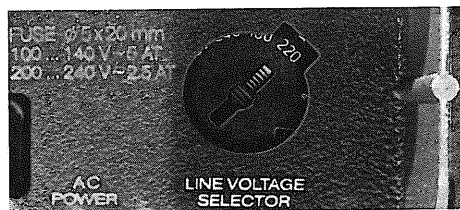

VÉRIFIEZ LA POSITION DU SÉLECTEUR DE TENSION

Alimentation: 100, 120, 140, 200, 220, 240 V \pm 10%, 50 ... 60 Hz
 Consommation: 50 W max.

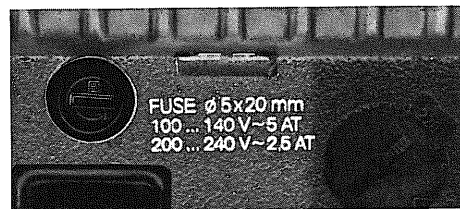

VÉRIFIEZ LE FUSIBLE SECTEUR

pour 100 ... 140 V: 630 mA (retardé)
 pour 200 ... 240 V: 315 mA (retardé)

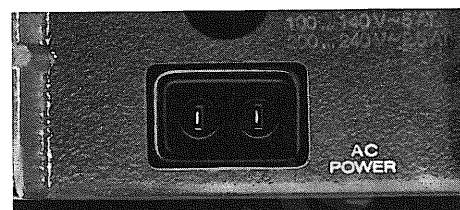

RACCORDEZ LE CÂBLE SECTEUR

Utilisez uniquement le câble livré avec l'appareil



RACCORDEZ L'ANTENNE

60 ... 75 ohms avec fiche coaxiale, selon DIN 45325 ou
 240 ... 300 ohms, symétrique, fiche plate, selon DIN 45316

Offrant un meilleur blindage contre les parasites, l'entrée coaxiale ne nécessite pas l'emploi d'un translateur qui amortit le signal d'environ 0,5 à 1,5 dB.

D'autres informations à la page 18.

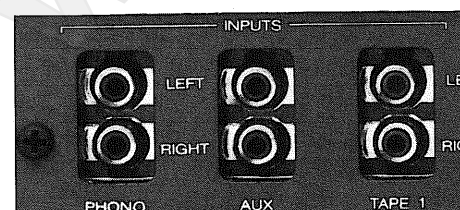

RACCORDEZ LES SOURCES voir également la page 20 et dépliant

PHONO: table de lecture avec phonocapteur magnétique

Sensibilité: 3 mV/47 kohms, 220 pF (pour une tension de sortie de 2 V). Rapport signal/bruit > 73 dB (5 mV/1 kHz). Correction phono (IEC 98, MOD. 4 1976) \pm 0,5 dB, 20 Hz à 20 kHz.

AUX: entrée de réserve (pour radio GO/PO/OC etc.)

TAPE 1: magnétophone 1

AUX, TAPE: sensibilité pour 2 V: 150 mV/50 kohms. Rapport signal/bruit > 90 dB

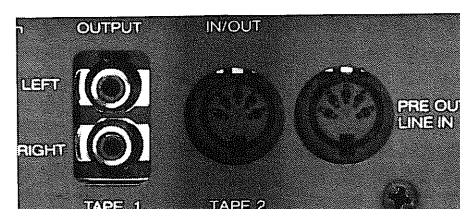

TAPE 2: magnétophone 2 ou magnétophone à cassettes (Raccord DIN)

AVIS:

Laissez les fiches «bouchon» rouges branchées aux prises d'entrées non utilisées!

Ces fiches améliorent le rapport signal/bruit et le recul de diaphonie.

Amortissement de la diaphonie (à 1 kHz): supérieur à 70 dB pour toutes les entrées.

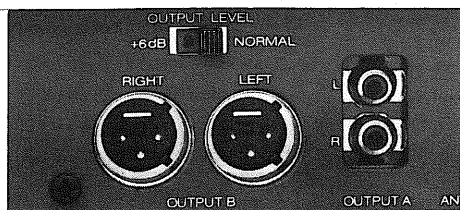

RACCORDEMENT DES AMPLIFICATEURS DE PUISSANCE

OUTPUT A: prises cinch
OUTPUT B: connecteur XLR

Tension de sortie: 2 V; impédance de sortie: 220 ohms

OUTPUT LEVEL: Commutation de la tension de sortie à 4 V.

+6 dB correspond à un redoublement; pour connecter des amplificateurs de puissance insensible



RACCORDEMENT DU CASQUE

Pour les casques d'une impédance de 8 ohms ou plus.

La sortie casque est permanente et indépendante de la sortie de l'amplificateur de puissance choisi.

Fiche Jack stéréo: 11,8 V/charge optimale 200 ... 800 ohms

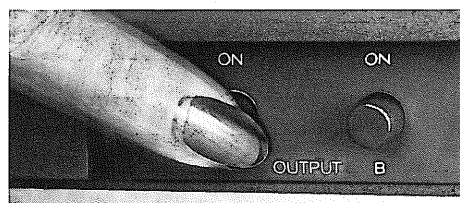

CHOIX DE LA SORTIE DE L'AMPLIFICATEUR DE PUISSANCE

Touche A: sorties cinch

Touche B: sorties XLR

A + B: les deux groupes de sortie simultanément

L'écoute au casque est possible même si les touches A et B sont déclenchées.

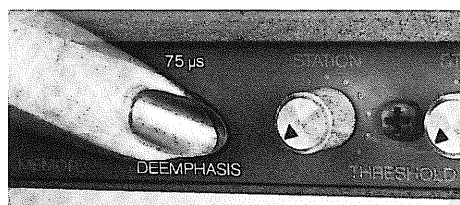

DÉSACCENTUATION

pour l'Europe: 50 μs touche relâchée

pour les USA: 75 μs touche enfoncée

Si l'appareil est équipé d'un système réducteur de bruit, la touche NOISE REDUCTION enfoncée détermine une désaccentuation de 25 μs.

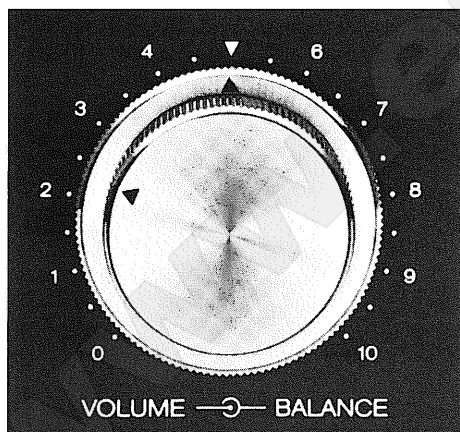

VOLUME D'ÉCOUTE

sur la position 2 environ

BALANCE

en position médiane

Réglage physiologique du volume: voir page 16

Réglage de la balance: pour compenser une éventuelle asymétrie des canaux ou de la disposition des enceintes acoustiques.

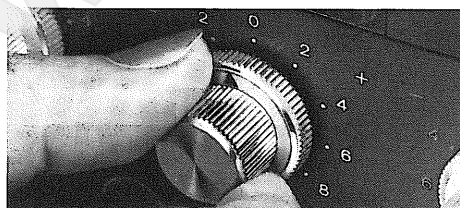

CONTRÔLES DE TONALITÉ EN POSITION MÉDIANE

D'autres informations à la page 15



FILTRES DÉCLENCHÉS (OFF)

D'autres informations à la page 16

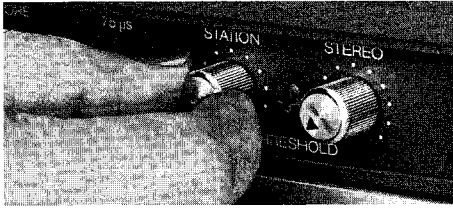

TOURNEZ LES RÉGLAGES AU MINIMUM, JUSQU'À LA BUTÉE GAUCHE

Seuil d'écoute STATION: 2 à 20 μ V à 75 ohms
Seuil d'écoute STÉRÉO: 5 à 500 μ V à 75 ohms pour la réception stéréo



DÉCLENCHÉZ LES TOUCHES RONDES INFÉRIEURES

Touche à encliquetage.
Une deuxième pression libère la touche.



MISE EN PLACE DES ACCUMULATEURS

La mémoire électronique des stations reste sous tension même lorsque l'appareil est déclenché. Toutefois pour éviter l'effacement de la mémoire et par là de perdre les fréquences présélectionnées en cas de coupure du secteur, il est nécessaire de placer les trois accumulateurs (type IEC KR 15/51) livrés avec l'appareil.

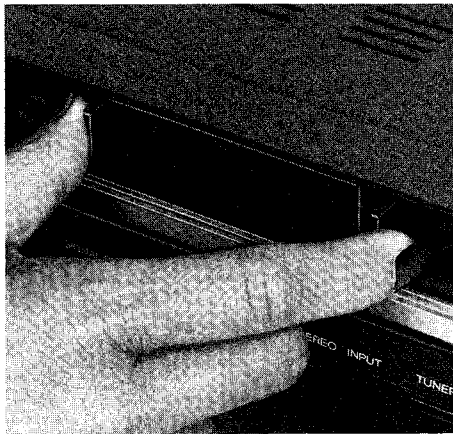

PRESSEZ LES LANGUETTES ET SORTEZ LE COMPARTIMENT À ACCUMULATEURS

Placez les accumulateurs en respectant la polarité indiquée au fond du compartiment.

ATTENTION:

N'utilisez en aucun cas de batteries sèches (alcalines, etc.)!

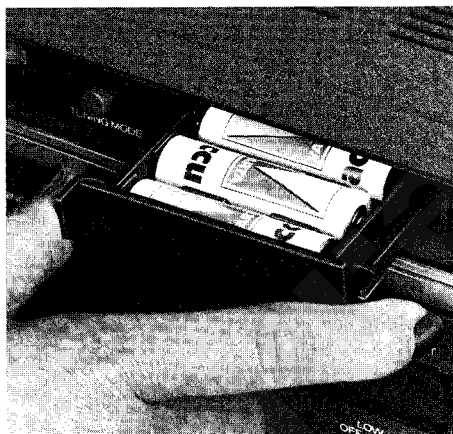

REPOUSSEZ LE COMPARTIMENT JUSQU'À LA BUTÉE

La CHARGE des accumulateurs s'effectue dès que l'appareil, enclenché ou non, est raccordé au secteur. La DURÉE DE CHARGE pour des accumulateurs déchargés est d'environ 3 jours. Le faible courant de charge élimine tout risque de surcharge. Une COUPURE DE SECTEUR est sans effet sur la mémoire pendant une semaine environ avec des accumulateurs chargés.

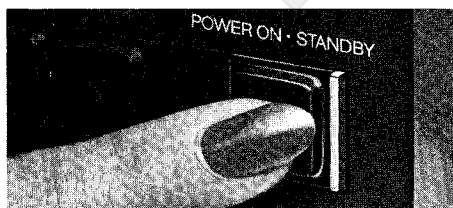

RACCORDEZ LA FICHE SECTEUR ET PRESSEZ LA TOUCHE POWER

Une deuxième pression sur la touche déclenche l'appareil.

3 SECONDES APRÈS L'ENCLÈCHEMENT L'ENSEMBLE RÉCEPTEUR EST PRÊT À FONCTIONNER.

Indicateur du signal reçu SIGNAL STRENGTH:

s'allume à l'enclenchement de l'appareil.
Lors du premier enclenchement les chiffres indiquent une fonction quelconque.

Par la suite, à l'enclenchement, c'est la dernière station ainsi que la dernière source écoutée qui apparaît.



MODE D'EMPLOI DE L'ÉLÉMENT RÉCEPTEUR

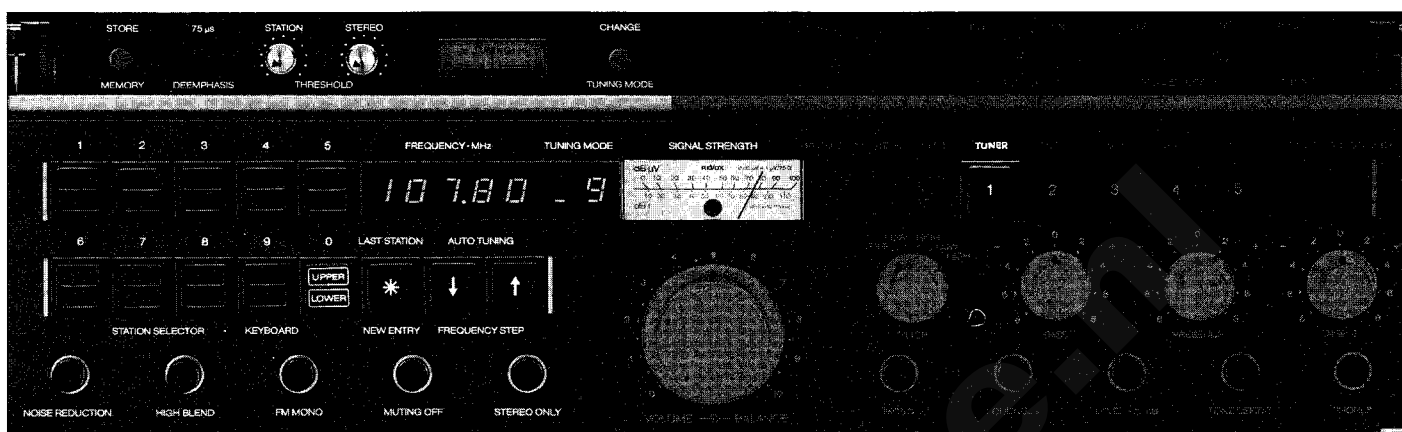

REMARQUE

Les illustrations de gauche montrent l'action sur l'organe de commande.

Les illustrations de droite montrent l'état annoncé après l'action sur l'organe de commande.

Toutes les fréquences de réception (indicateur FREQUENCY · MHz) de ce mode d'emploi ne sont que des exemples; demandez à votre détaillant une table des fréquences de réception concernant votre région.

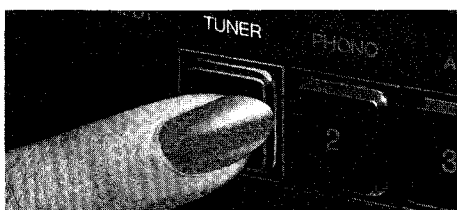

Appuyez sur la touche TUNER. L'indicateur INPUT annonce «1». Cela signifie que la partie réception est raccordée à l'amplificateur.



RECHERCHE AUTOMATIQUE

En mode de recherche automatique toute la bande de réception de 87,5 à 107,95 MHz est balayée par bonds de 100 kHz. Lorsque le récepteur perçoit un signal d'intensité suffisante, l'accord s'effectue alors par pas de 50 kHz (par ex. 89,850 MHz).

ATTENTION:

Après l'enclenchement de l'ensemble récepteur, l'indicateur TUNING MODE affiche toujours un chiffre (1 ... 9). Si par une manipulation décrite plus loin, un «F» (mode de composition de la fréquence) apparaissait, il faut simplement appuyer sur la touche CHANGE TUNING MODE pour remettre l'appareil en mode présélection de stations et recherche automatique.

EXEMPLE DE RECHERCHE D'UNE STATION

Le processus de recherche entre en action dès qu'une des touches AUTO TUNING est sollicitée, qu'une fréquence soit déjà affichée ou non, en avant (87,50 MHz) ou en arrière (107,95 MHz).

Supposons que la fréquence de 98,50 MHz soit affichée.

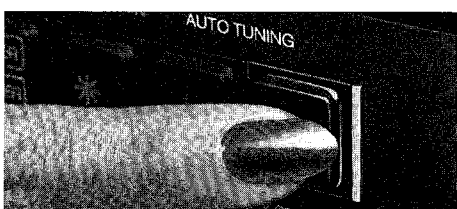

Appuyez sur la touche AUTO TUNING ↑ pour faire avancer la recherche.

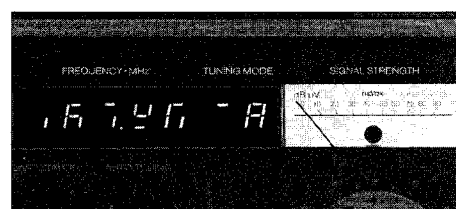
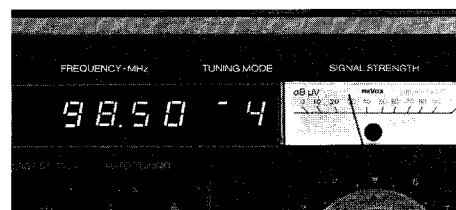

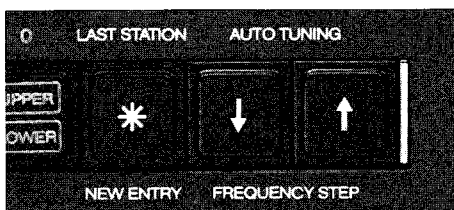

L'AVANCE AUTOMATIQUE S'ARRÊTE

Un émetteur de 98,80 MHz (exemple) est reçu, sur lequel l'appareil s'est accordé à la précision du quartz.

Précision de la référence à quartz:
± 0,0025%

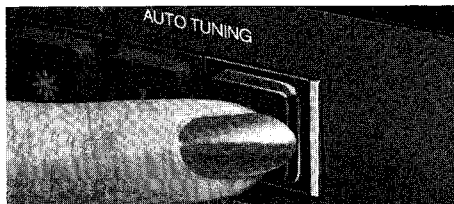
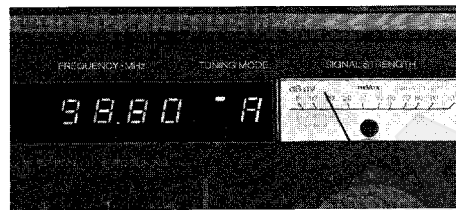

AUTO TUNING ↑
Avance de la recherche

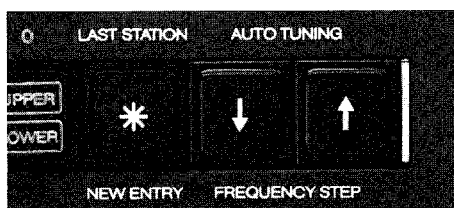
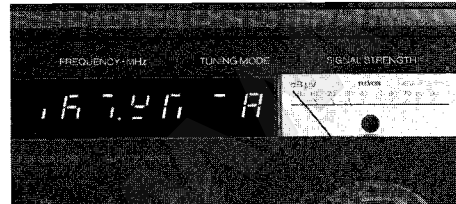

Un émetteur de 99,10 MHz (exemple) est reçu.

Indicateur d'intensité du signal SIGNAL STRENGTH
0 ... 100 dB μ V (0 dB μ V \triangleq 1 μ V/75 ohms)
10 ... 110 dBf (0 dBf \triangleq 10⁻¹⁵ watt)

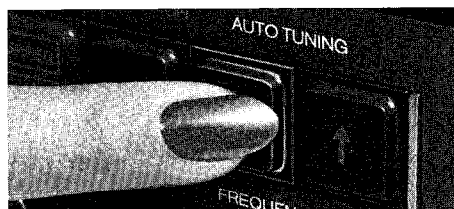
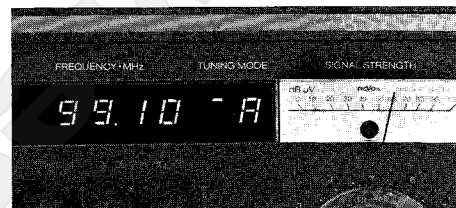

AUTO TUNING ↓
Retour de la recherche

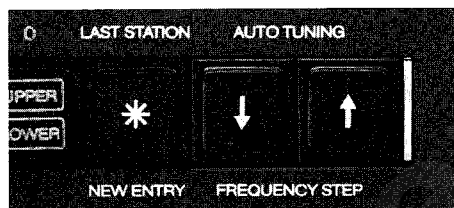
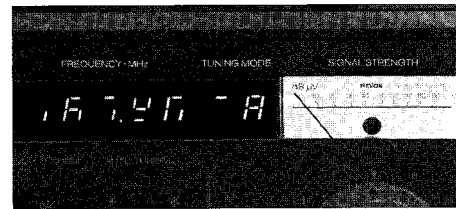

L'émetteur de 98,80 MHz est de nouveau reçu.

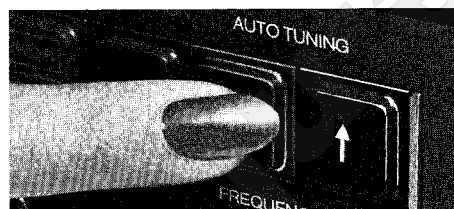
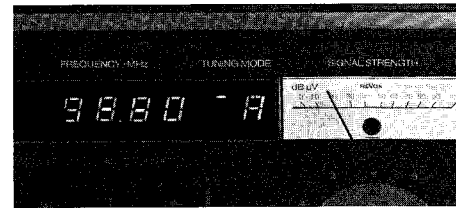

L'appui continu sur l'une des touches AUTO TUNING provoque le défilement rapide des fréquences, dans un sens ou dans l'autre.

Dans ce cas, la recherche ne s'effectue pas. Sitôt la touche libérée, la recherche automatique s'effectue jusqu'à l'apparition d'un émetteur.

Autres caractéristiques techniques de l'élément récepteur:

Réjection image:	106 dB; $\Delta f = 2 \times f_{FI}$
Réjection de la fréquence intermédiaire:	110 dB; f_{FI}
Affaiblissement de l'intermodulation:	106 dB; $\Delta f = f_{FI}/2$
Rapport de capture:	0,8 dB, mesuré avec une excursion de 40 kHz, un rapport signal/bruit de 30 dB et 1 mV de tension d'antenne 75 ohms
Sélectivité:	80 dB, signal utile 100 μ V/75 ohms, signal perturbateur 1 mV/75 ohms modulé avec 40 kHz d'excursion
Réjection de la modulation d'amplitude:	70 dB, se rapportant à 75 kHz d'excursion, à 30% de modulation d'amplitude à 400 Hz et à 1 mV de tension d'antenne 75 ohms
Bande passante:	30 Hz ... 15 kHz \pm 1 dB, mesurée avec 40 kHz d'excursion et 1 mV de tension d'antenne 75 ohms
Distorsion BF:	0,075%, mesurée à 1 kHz avec 40 kHz d'excursion, mono et stéréo G = D, 1 mV de tension d'antenne 75 ohms

MISE EN MÉMOIRE DES FRÉQUENCES DE RÉCEPTION

Chaque fréquence apparaissant dans l'indicateur FREQUENCY · MHz peut être mise dans l'une des 18 mémoires de station. A chaque mémoire correspond un chiffre qui apparaît dans l'indicateur TUNING MODE. Un trait lumineux avant ce chiffre identifie le groupe des mémoires: trait $\bar{\quad}$ (en haut): groupe 1 ... 9 DU HAUT, trait $\underline{\quad}$ (en bas): groupe 1 ... 9 DU BAS.

Les mémoires sont numérotées comme suit:

en haut (UPPER): $\bar{1}$, $\bar{2}$, $\bar{3}$, $\bar{4}$, $\bar{5}$, $\bar{6}$, $\bar{7}$, $\bar{8}$, $\bar{9}$

en bas (LOWER): $\underline{1}$, $\underline{2}$, $\underline{3}$, $\underline{4}$, $\underline{5}$, $\underline{6}$, $\underline{7}$, $\underline{8}$, $\underline{9}$ (voir également la page 17)

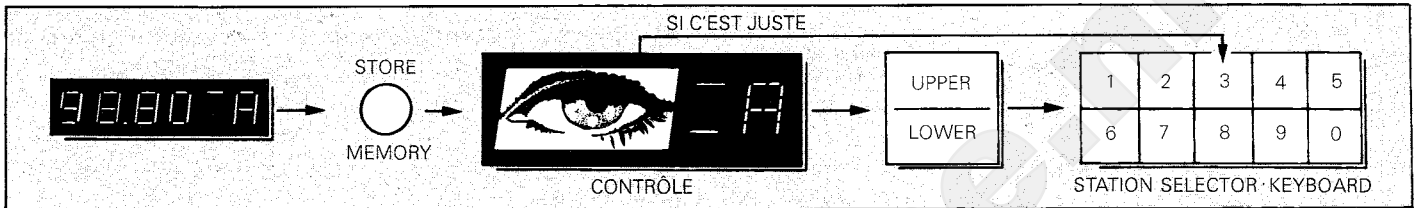

MARCHE À SUIVRE POUR LA MISE EN MÉMOIRE

EXEMPLE:

Introduction dans la mémoire 4 DU HAUT ($\bar{4}$), de la dernière station trouvée par la recherche automatique.

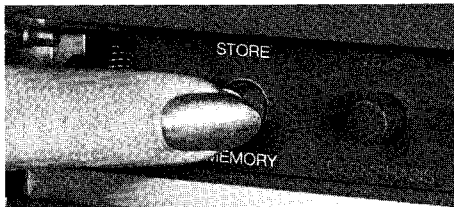

Appuyez sur STORE MEMORY

Le «A» clignote

Si aucune touche de station n'est sollicitée, le clignotement s'arrête au bout de 20 secondes environ.

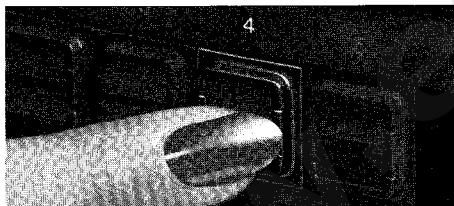
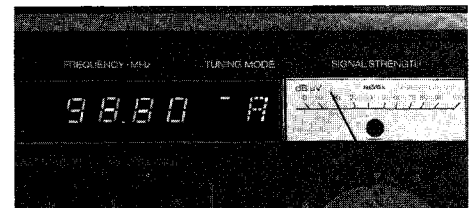

CONTRÔLEZ LE GROUPE DE MÉMOIRE

STATION SELECTOR «4»

La fréquence 98,80 MHz est maintenant inscrite dans la mémoire $\bar{4}$ (DU HAUT).

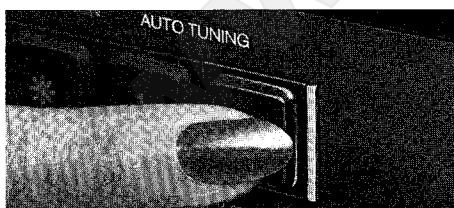

À l'aide de la recherche automatique une autre station est trouvée, puis inscrite dans la mémoire 2 DU BAS ($\underline{2}$).

AUTO TUNING ↑

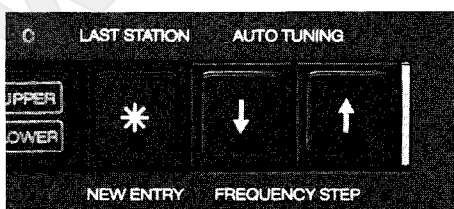
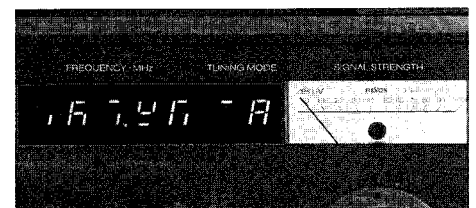

99,10 MHz

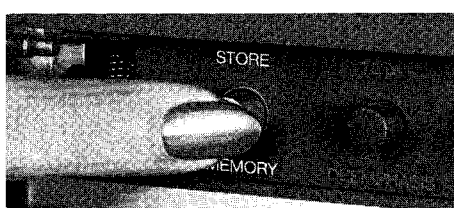
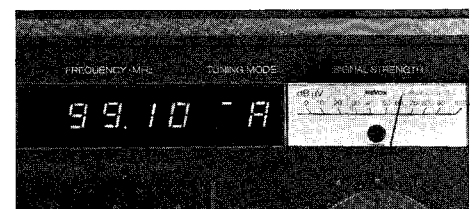

STORE MEMORY

CONTRÔLE DU GROUPE DE MÉMOIRE

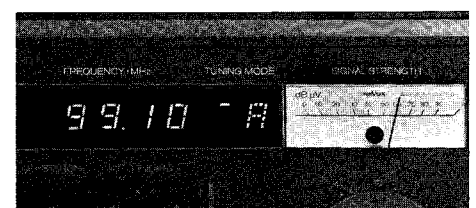

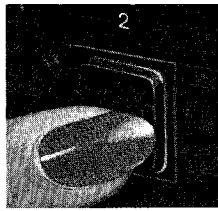
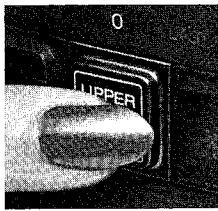

Choix du groupe de mémoire DU BAS (LOWER) avec la touche UPPER/LOWER STATION SELECTOR (2)

La fréquence de 99,10 MHz est maintenant inscrite dans la mémoire _2 (2 DU BAS).

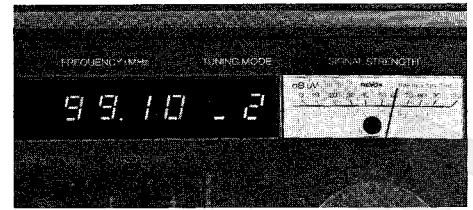

Ainsi à toutes les touches 1... 9 du STATION SELECTOR - KEYBOARD correspondent 2 mémoires (EN HAUT et EN BAS) qui peuvent contenir n'importe quelle fréquence. Même une station qui n'émet pas continuellement peut être mémorisée. La mise en mémoire s'effectue sans effacement préalable d'une touche éventuellement déjà occupée.

EFFACEMENT DE LA MÉMOIRE:

Il est possible d'effacer le contenu de chacune des mémoires de station en y introduisant une donnée neutre:

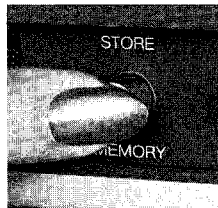
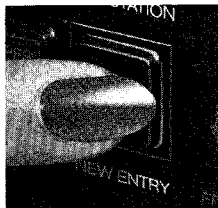

Appuyer sur la touche CHANGE TUNING MODE pour obtenir le mode (F); puis appuyez successivement sur les touches NEW ENTRY et STORE MEMORY

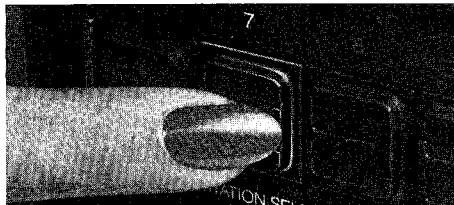
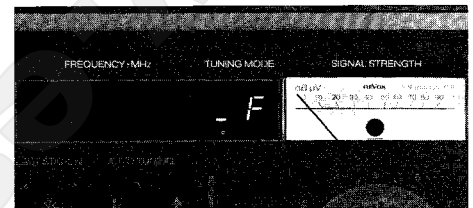

CONTRÔLEZ LE GROUPE DE MÉMOIRE

STATION SELECTOR (7)

Ainsi la mémoire _7 (7 EN BAS) est vide.

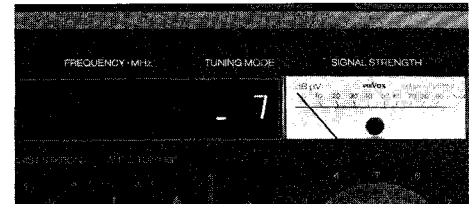

APPEL D'UNE FRÉQUENCE DE STATION MÉMORISÉE

Si l'on veut recevoir la station dont la fréquence est mémorisée dans la mémoire 4 EN HAUT (↑4)...

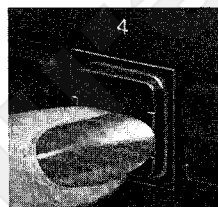
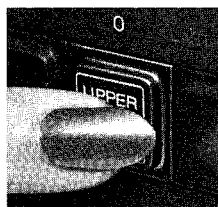

UPPER/LOWER (contrôle) et STATION SELECTOR (4)

La fréquence de 98,80 MHz est reçue

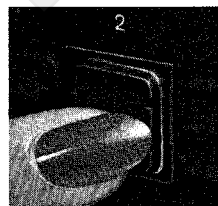
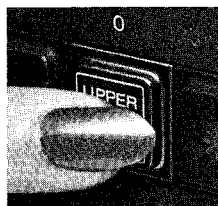
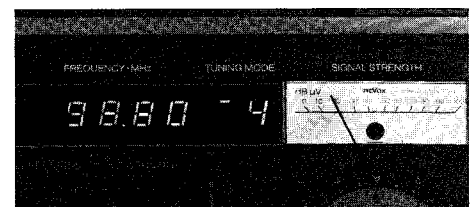

...ou la station de la mémoire 2 EN BAS (↓2)

Pour changer de groupe, la touche UPPER/LOWER doit toujours être pressée avant la touche de station. Le trait lumineux clignote pendant 20 secondes environ, ou jusqu'à ce qu'une touche de station soit sollicitée.

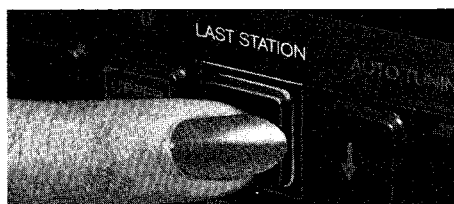
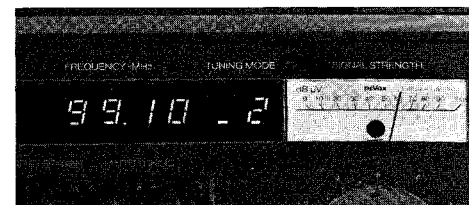

Touche LAST STATION: une pression sur cette touche permet de revenir la dernière fréquence de réception trouvée en recherche automatique et de continuer la recherche.

Cette dernière fréquence reste en mémoire même si l'appareil est déclenché. La touche LAST STATION permet en outre la comparaison entre deux fréquences de réception différentes pour un même programme.

Déplacement de fréquences mémorisées: la fréquence mémorisée contenue dans la mémoire (A) peut être directement déplacée dans la mémoire (B); ce qui va entraîner dans ce cas l'effacement du contenu éventuel de la mémoire (B). Marche à suivre: appelez la fréquence (A), appuyez sur STORE MEMORY et pressez sur la nouvelle touche de station (B).

EFFACEMENT INVOLONTAIRE:

Notez les fréquences mémorisées ainsi que leur place! Veuillez vous référer à la table en première page.

COMPOSITION D'UNE FRÉQUENCE D'ÉMISSION CONNUE

Relevée dans un journal de programme par exemple, une fréquence d'émission peut être directement composée. Pour cela il faut changer le mode d'accord (TUNING MODE «F»).

Exemple: La fréquence d'émission est 98,50 MHz

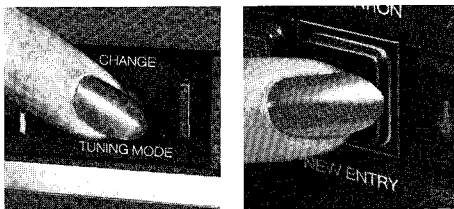

Appuyez successivement sur CHANGE TUNING MODE et NEW ENTRY.

En appuyant sur NEW ENTRY, l'indicateur de fréquence s'éteint et le récepteur est mis sous silence.

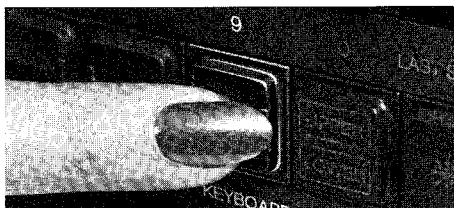
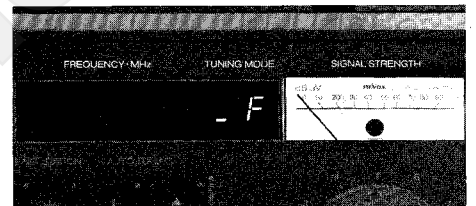

9

Le point décimal s'allume automatiquement.

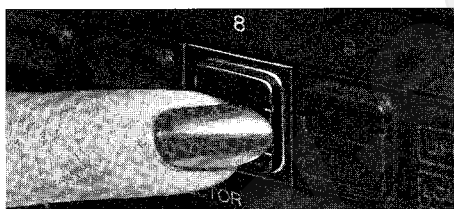

8

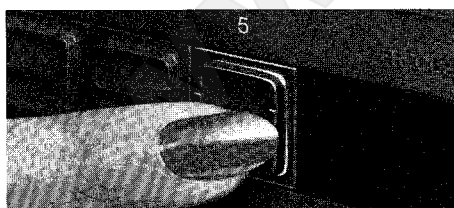
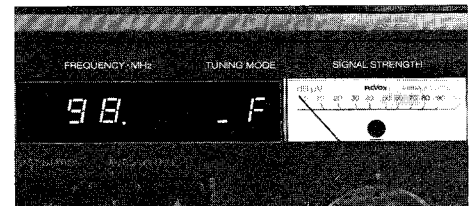

5

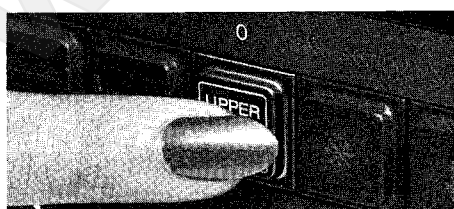
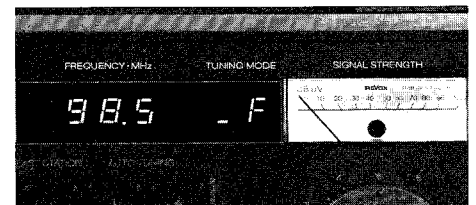

0

Pour les émetteurs avec un pas de 25 kHz, on composera la fréquence jusqu'au deuxième chiffre après la virgule seulement. Exemple 89,125 MHz: 89,12

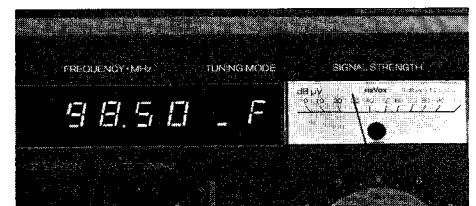

Après la composition du dernier chiffre, le récepteur est en fonction.

L'aiguille de l'instrument SIGNAL STRENGTH indique l'intensité du signal reçu.



Lorsque l'accord avec la fréquence de réception est correct, l'aiguille de l'instrument TUNING est au milieu.

Déviations: 20 kHz par mm

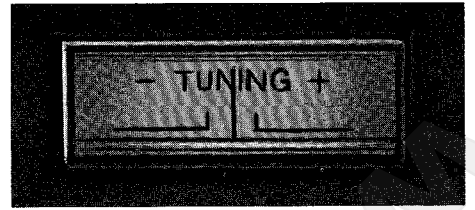

Erreur de composition:

La composition d'une fréquence hors de la gamme de réception ou hors d'un pas de 25 kHz est annoncée comme erreur par le clignotement du dernier chiffre composé. Exemple: 87,40 MHz.

La composition du chiffre correct arrête le clignotement.

Correction:

Lors d'une erreur il est nécessaire d'appuyer sur la touche NEW ENTRY avant de composer une nouvelle fréquence.

Clignotement de l'indicateur de fréquence:

Le circuit de silence MUTING est activé.

Raisons: absence d'émission, signal trop faible, seuil de commutation THRESHOLD STATION trop élevé ou émission en monophonie avec la touche STEREO ONLY enfoncée.

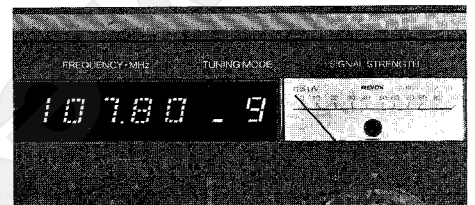
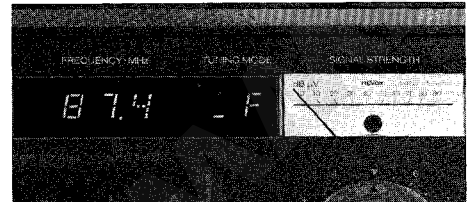

Arrêt du clignotement:

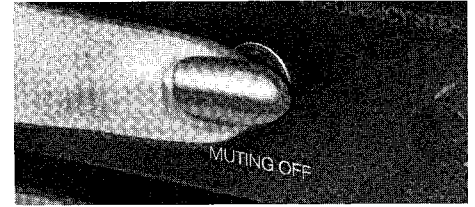
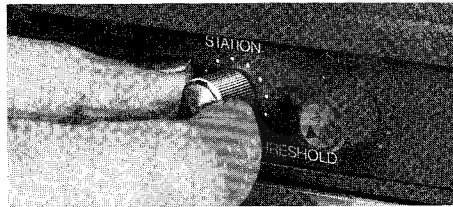
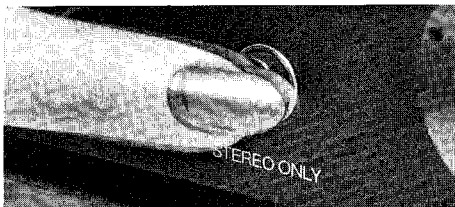

Libérez la touche STEREO ONLY ou tournez le bouton THRESHOLD STATION à la butée gauche ou appuyez sur MUTING OFF

Seuil de commutation: 2 ... 20 µV à 75 ohms

Sensibilité limite: 0,7 µV mesurée à l'entrée 75 ohms pour un rapport signal/bruit de 26 dB avec excursion de 40 kHz.

RÉCEPTION STÉRÉO

Composez une nouvelle fréquence, par exemple un émetteur stéréo de 102,40 MHz.

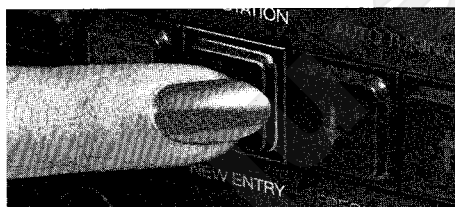

Commutez le mode d'accord <F>
NEW ENTRY

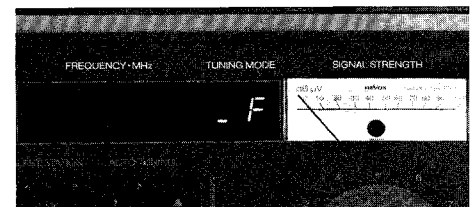

STATION SELECTOR
1, 0, 2, 4, 0

La nouvelle fréquence est reçue.

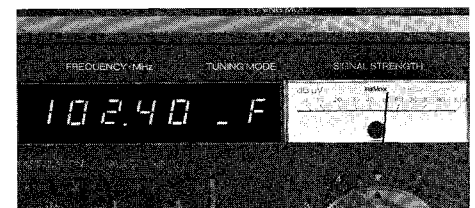

L'indicateur stéréo FM STEREO s'allume.

La réception stéréophonique acceptable nécessite un signal d'antenne plus élevé de 20 dB (soit 10 fois) qu'une réception monaurale. Si la réception stéréo est accompagnée d'un souffle, le signal d'entrée est trop faible.

Sensibilité effective:

Mono: 2 µV; stéréo: 20 µV
mesurées à l'entrée 75 ohms pour un rapport signal/bruit de 46 dB avec excursion de 40 kHz

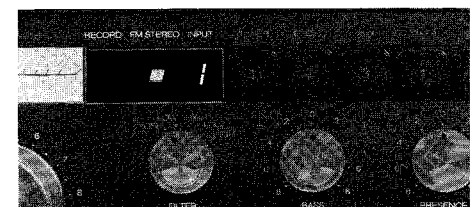

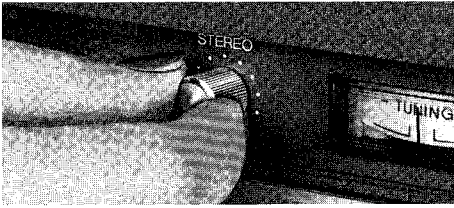

THRESHOLD STEREO

Détermine le seuil de commutation mono/stéréo de manière à n'écouter en stéréophonie que les stations stéréo reçues dans de bonnes conditions.

Seuil de commutation: 5 ... 500 μ V à 75 ohms



HIGH BLEND

Permet d'éliminer le souffle lors d'écoute des stations stéréo faibles.

Dans ce cas la séparation des canaux stéréo sera légèrement réduite. Sans modification de la bande passante, le souffle de réception est atténué de 7 dB (pour 50 μ V à 75 ohms). Amortissement de la diaphonie (touche HIGH BLEND libérée): 42 dB à 1 kHz, 40 kHz d'excursion et 1 mV de tension d'antenne à 75 ohms. Amortissement de la diaphonie (touche HIGH BLEND enfoncée): 10 dB.

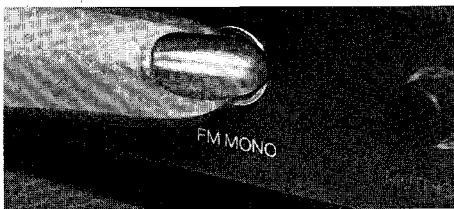

FM MONO

Annule la séparation des canaux. Permet d'éliminer le souffle important lors de mauvaises conditions de réception de stations stéréo.

Cette touche n'influence pas la reproduction stéréo de l'élément amplificateur.



STEREO ONLY

Seules les stations stéréo sont reçues. Les stations mono sont mises sous silence (clignotement de l'indicateur de fréquence).

Réglez le seuil de commutation avec THRESHOLD STEREO

Les stations stéréo faibles dont le signal de réception est en-dessous du seuil de commutation THRESHOLD STATION, sont également mises sous silence.

Réjection du signal pilote et de la sous-porteuse:

70 dB, (harmoniques comprises)

15 kHz ... 300 kHz linéaire se rapportant à une excursion de 75 kHz mesurée avec 1 mV de tension d'antenne 75 ohms

En recherche automatique avec la touche STEREO ONLY enfoncée, il est facile de fixer l'intensité minimum des stations stéréo:

Appuyez sur la touche STEREO ONLY

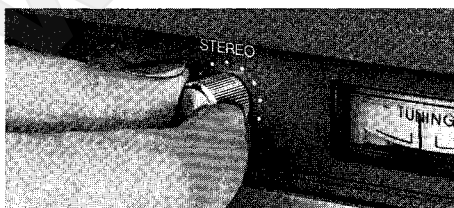

Réglez le THRESHOLD STEREO

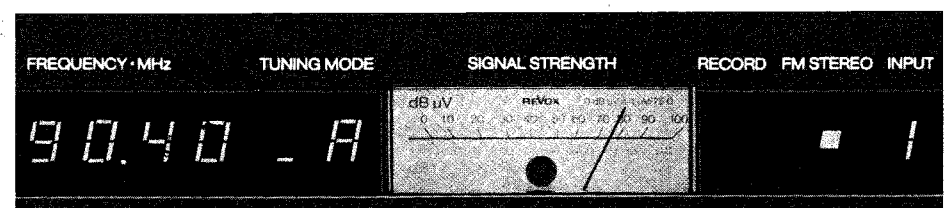
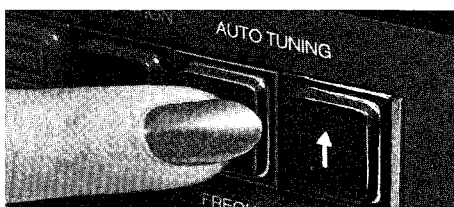

RECHERCHE MANUELLE

Toute la gamme de réception peut être explorée manuellement par pas de 25 kHz. Ceci est particulièrement intéressant lorsque la fréquence d'une station n'est que partiellement connue (ou qu'une station trouvée par la recherche automatique doit être accordée sur un pas de 25 kHz).

Exemple: une station juste au-dessous de 90 MHz doit être accordée:

Composez 90,00 MHz
Mode d'accord (F), NEW ENTRY, 9000

Aucun émetteur n'est reçu et l'indicateur clignote.

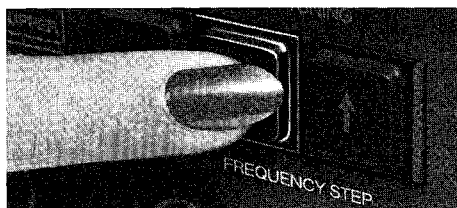
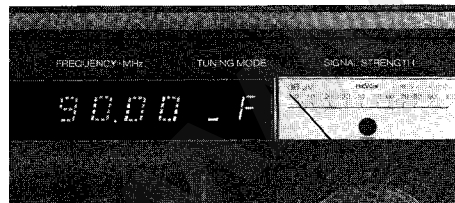

FREQUENCY STEP ↓

L'aiguille de l'instrument SIGNAL STRENGTH indique un signal faible

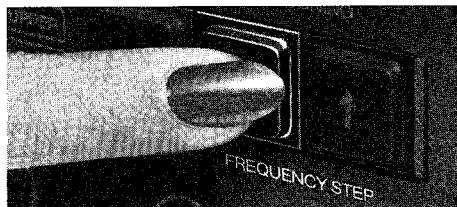
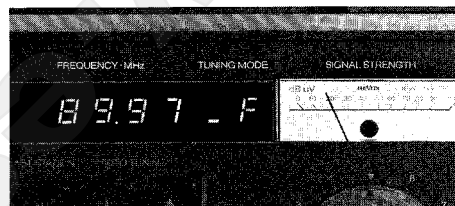

FREQUENCY STEP ↓

L'aiguille de l'instrument SIGNAL STRENGTH indique un signal toujours plus important

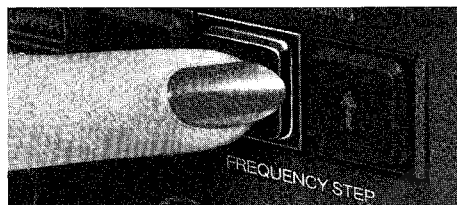
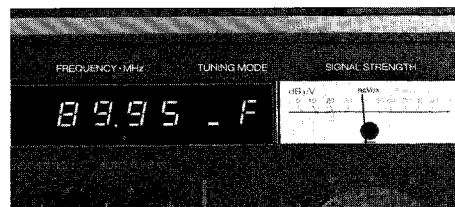

FREQUENCY STEP ↓

etc. Comme pour un récepteur avec bouton d'accord, la fréquence d'émission peut être exactement ajustée à l'aide des instruments TUNING et SIGNAL STRENGTH.

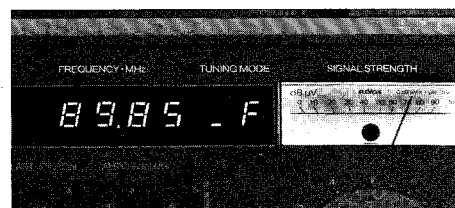

L'aiguille de l'instrument TUNING doit se trouver au centre.

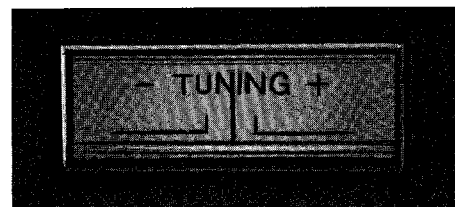

Une pression continue sur une des touches FREQUENCY STEP provoque l'avance rapide comme en recherche automatique. Le relâchement de la touche provoque l'arrêt immédiat.

RÉDUCTION DE BRUIT

Seulement si l'appareil est équipé du circuit réducteur de bruit DOLBY®

Montage sans réglage, après la dépose de la paroi gauche et du circuit de substitution.

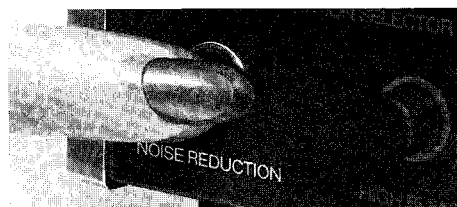

NOISE REDUCTION

La lampe au milieu de l'instrument SIGNAL STRENGTH s'allume.

Cette touche ne doit être enfoncée qu'à l'écoute d'émissions dolbylisées, sans quoi il s'en suivrait une modification de la bande passante.

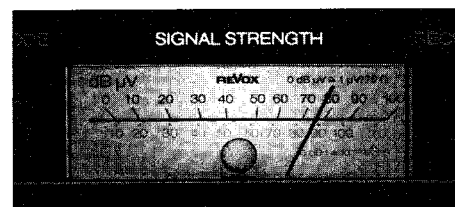

MODE D'EMPLOI DE L'ÉLÉMENT AMPLIFICATEUR



CHOIX DES SOURCES/ SÉLECTION D'ENTRÉE

Les touches de sélection d'entrée 1 ... 5 ont une fonction double: commuter l'élément récepteur ou les entrées à l'élément amplificateur et/ou aux sorties magnétophones. Au déclenchement de l'ensemble récepteur, les sources de modulation choisies restent en mémoire.

ÉLÉMENT AMPLIFICATEUR

L'indicateur INPUT affiche la source de modulation.

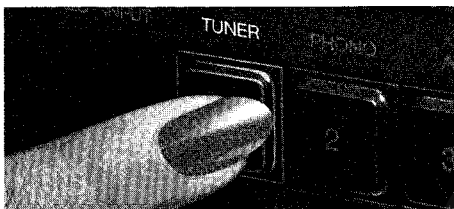

TUNER élément récepteur

Sortie BF Tuner:
15 kHz d'excursion/400 Hz: 70 watts/8 ohms à la sortie SPEAKER A/B
Recul du bruit de fond:
75 dB, 30 Hz ... 15 kHz linéaire, mesuré avec
1 mV de tension d'antenne 60 ohms, en fonction
d'une excursion de 75 kHz

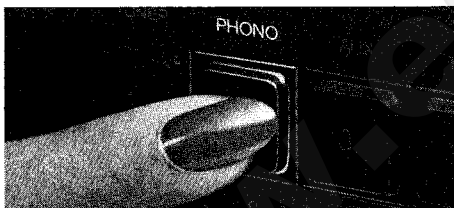
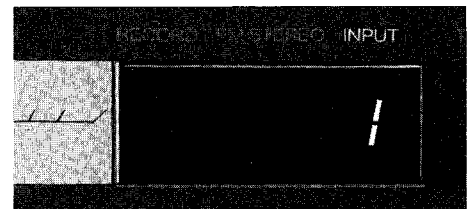

PHONO table de lecture

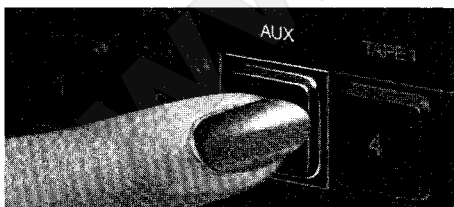
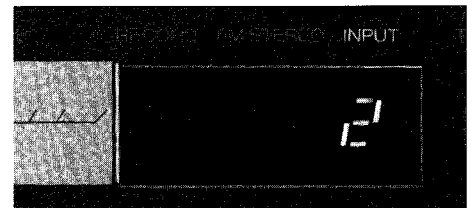

AUX entrée auxiliaire pour radio GO,
PO, OC, etc.

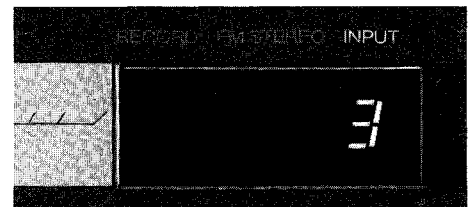

TAPE 1 magnétophone 1
lecture

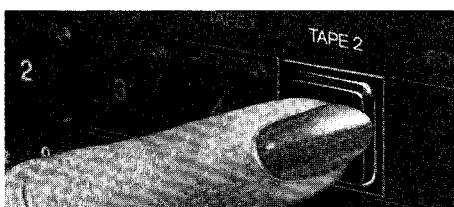
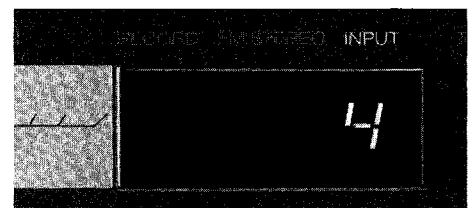

TAPE 2 magnétophone 2
lecture

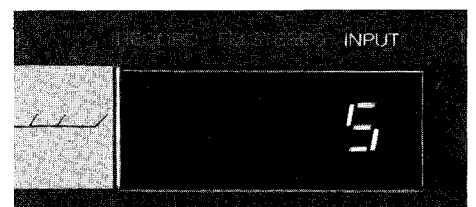

ENREGISTREMENT

L'indicateur RECORD affiche la source de modulation (1 ... 5) qui est commutée aux sorties magnétophone TAPE 1 OUTPUT (CINCH) et TAPE 2 OUT (DIN). Le choix de l'une de ces sources de modulation est indépendant du choix de l'entrée écoutée (indicateur INPUT).

Exemple: enregistrement à partir de l'élément récepteur.

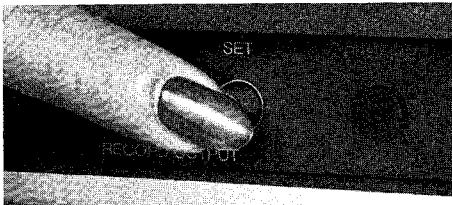

RECORD OUTPUT SET

Dans l'indicateur RECORD apparaît un trait clignotant ou le chiffre de la dernière source enregistrée.

Si après 20 secondes aucune autre touche n'est sollicitée, le trait clignotant disparaît.

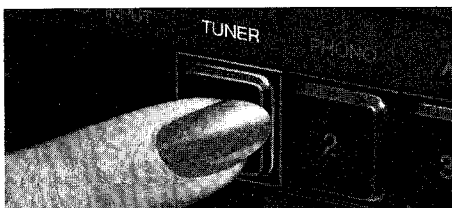
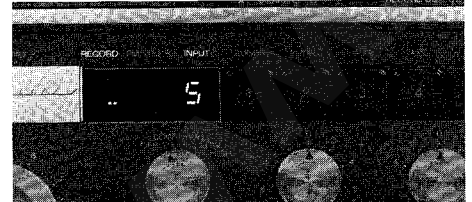

TUNER

Dans l'indicateur RECORD le chiffre 1 s'allume.

Bien qu'un programme FM s'enregistre sur le magnétophone 1, il est possible d'écouter simultanément une autre source, par exemple le magnétophone 2.

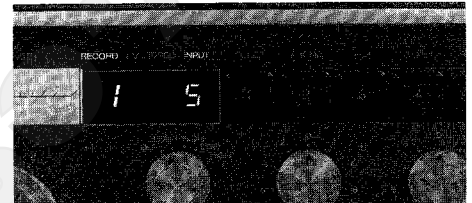

Exceptions:

l'entrée TAPE 1 (4) ne peut être commutée qu'à la sortie TAPE 2 et l'entrée TAPE 2 (5) qu'à la sortie TAPE 1 (pour éviter des accrochages). Pendant la recherche automatique, aucune commutation ne peut être effectuée.

Tensions de sortie:
TAPE 1 (Cinch): 135 mV/R_L min. 47 kohms, TAPE 2 (DIN): 5.5 mV/R_L 10 kohms.
Sortie BF T: 75 kHz d'excursion/400 Hz donne 0.7 V sur TAPE 1

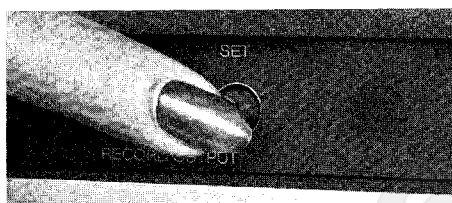

Coupure (mise sous silence) des sorties magnétophones

RECORD OUTPUT SET

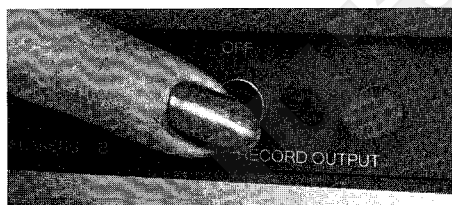

RECORD OUTPUT OFF

Les sorties TAPE non utilisées peuvent être coupées.

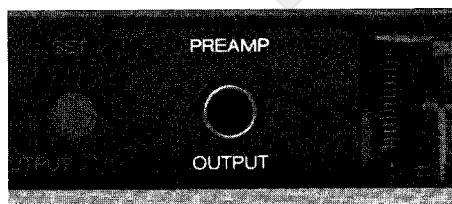
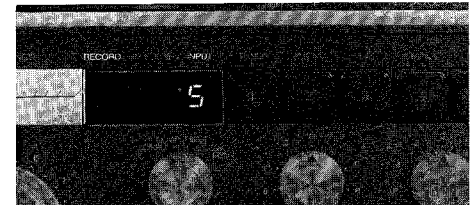
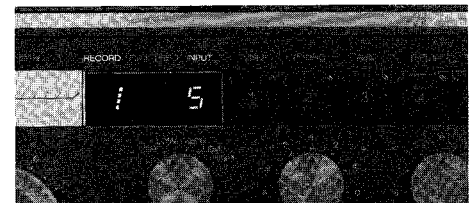

AUTRES SORTIES

PREAMP OUTPUT

Raccordement Jack (stéréo)

Sortie préamplificateur

Tension de sortie 0.85 V/R_L min. = 47 kohms

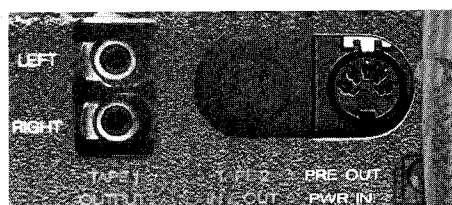

PRE OUT

Raccordement DIN (stéréo)

Tension de sortie 0.85 V/R_L min. = 10 kohms

PWR IN

Entrée amplificateur de puissance

1 V/50 kohms

Attention:
Le fait d'enfoncer une fiche DIN dans cette prise interrompt la liaison entre le préamplificateur et l'amplificateur de puissance. Ceci permet d'insérer par cette prise un filtre ou un égaliseur, etc.

CONTRÔLE DE TONALITÉ/FILTRES



RÉGLAGE DE LA TONALITÉ

Ces réglages agissent sur les deux canaux.

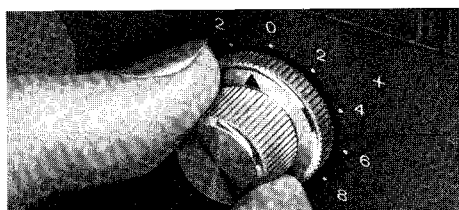

BASS Réglage des graves

± 8 dB à 120 Hz

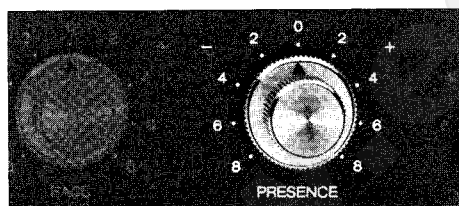

PRESENCE Réglage des médiums

± 8 dB à 3 kHz

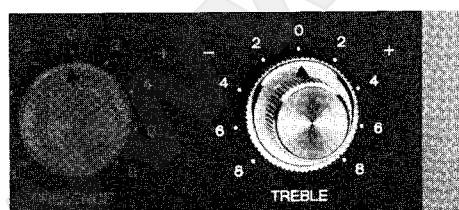

TREBLE Réglage des aigus

± 8 dB à 8 kHz

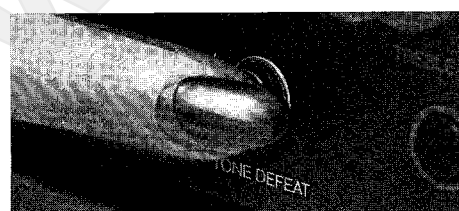

TON DEFEAT

Déconnecte les réglages de tonalité et produit ainsi une reproduction linéaire.

Pour autant qu'ils soient enclenchés, les filtres LOW/HIGH sont toujours en service.

FILTRES

Les filtres agissent sur les deux canaux
Position LOW: filtre grave, atténue les très basses fréquences (ronflements)
Position HIGH: filtre aigu, atténue les très hautes fréquences (souffle)
Position LOW/HIGH: les deux filtres sont actifs



LOW

50 Hz, -3 dB (12 dB/octave)

HIGH

8 kHz, -3 dB (12 dB/octave)

AUTRES ORGANES DE COMMANDE DE L'AMPLIFICATEUR

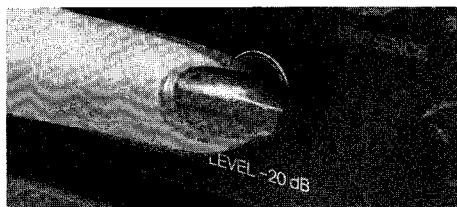

LEVEL -20 dB

Réduction linéaire du volume de -20 dB correspondant à un volume réduit à 25%.

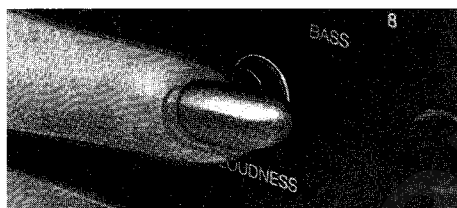

LOUDNESS

Correction physiologique du volume

à -40 dB (position 4 env.): 100 Hz + 5 dB et 10 kHz + 6 dB

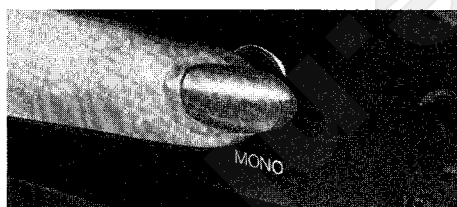

MONO

Reproduction monaurale.

Les canaux gauche et droit de l'élément amplificateur sont mélangés, sauf sur les sorties magnétophone.

Il est ainsi possible d'écouter en monophonie une modulation provenant de l'entrée AUX par exemple et d'enregistrer simultanément une émission en stéréophonie.

**CARACTÉRISTIQUES TECHNIQUES
COMPLÉMENTAIRES**

Distorsion harmonique (1 kHz):	inférieure à 0,02% à 2 V (tension de sortie)
Réponse en fréquence:	+ 0/-0,7 dB, 20 Hz ... 20 kHz
Composants:	100 transistors, 77 diodes, 19 doubles diodes varicap, 45 IC, 1 micro-ordinateur 4K x 8 Bit, 3 redresseurs en pont, 9 indicateurs à 7 segments
Poids:	env. 13 kg
Dimensions (L x H x P):	452 x 151 x 350 mm

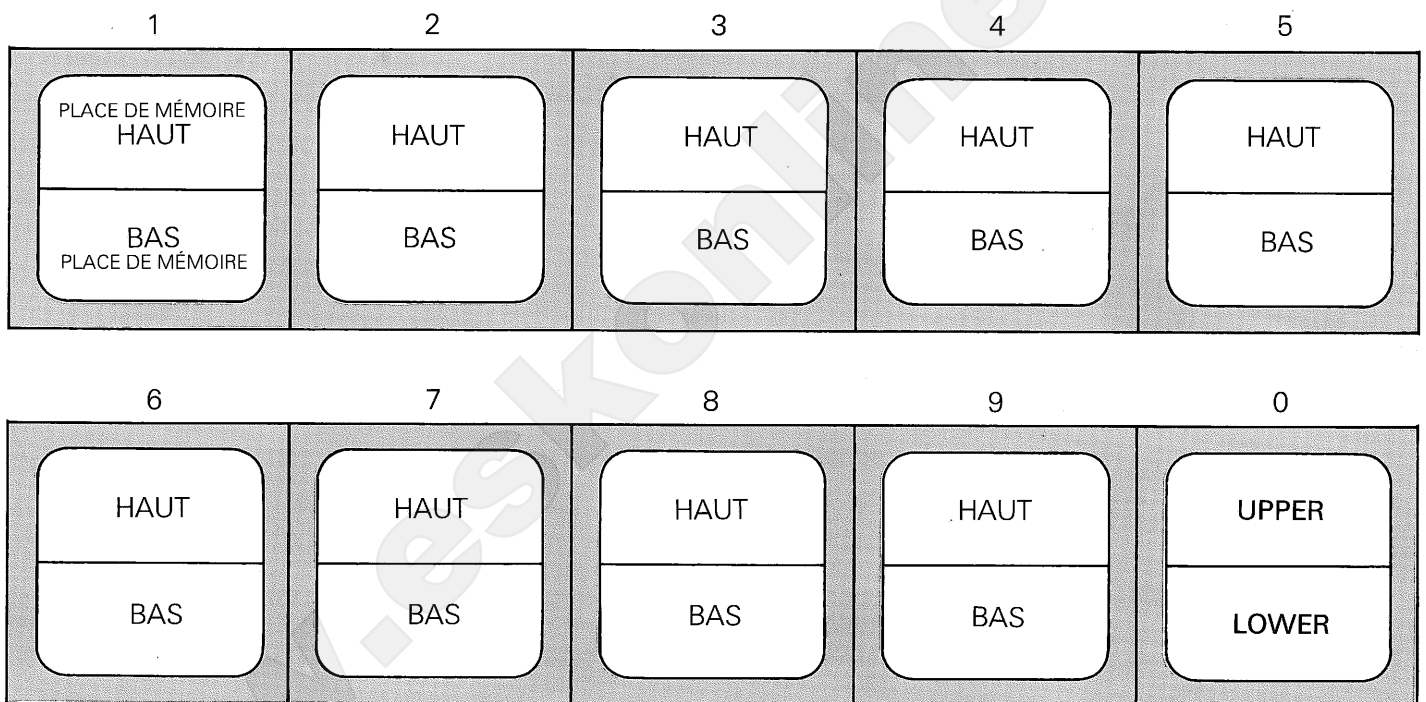

ORGANISATION DES MÉMOIRES DE STATION

PRÉSÉLECTION

GARANTIE

Une carte de garantie spéciale accompagne les appareils vendus en Belgique, République fédérale d'Allemagne, Autriche et France. Elle se trouve soit à l'intérieur de l'emballage, soit à l'extérieur dans une pochette en plastique. Si cette carte devait manquer, veuillez vous adresser à votre fournisseur REVOX ou à l'agence officielle REVOX de votre pays.

Remplissez correctement cette carte de garantie et envoyez-la à l'agence officielle REVOX du pays d'achat.

Pour les appareils achetés en Suisse, l'attestation de garantie est délivrée par le fournisseur REVOX autorisé. Nous vous rappelons que la garantie n'est valable que dans le pays où a lieu l'achat et qu'elle cesse automatiquement en cas d'intervention ou de réparation pratiquée sur l'appareil par un tiers non autorisé.

ANTENNES OUC (FM)

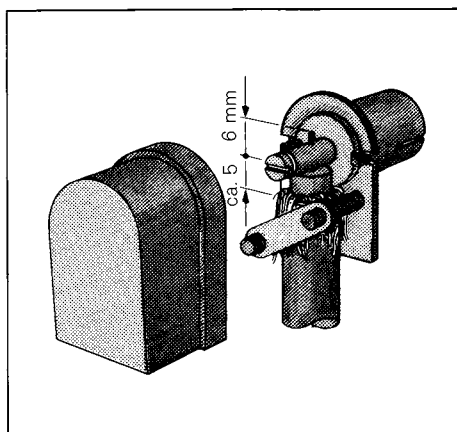

Afin de bénéficier au maximum des qualités du B780, il est nécessaire de le raccorder à une installation d'antenne délivrant une tension haute fréquence suffisante.

La solution idéale est l'emploi d'une antenne rotative extérieure ayant des caractéristiques directionnelles et un gain élevé. En relation avec la commande de rotor d'antenne (livrable en option) l'orientation de l'antenne peut être programmée par station.

Bien souvent les installations d'antenne collective délivrent un signal OUC de bonne qualité.

Si le B780 ne peut être raccordé à une antenne extérieure ou collective, il est toujours possible d'utiliser une antenne intérieure, pour autant que le signal correspondant aux émetteurs reçus soit important.

Car en effet ces antennes, de par leurs dimensions réduites, ont un faible gain qui ne favorise pas la réception déjà fort atténuée par les murs en béton armé des constructions modernes.

D'autre part, les signaux perturbateurs sont également plus importants dans ces grands bâtiments. Il est toutefois possible d'avoir une bonne réception avec une antenne intérieure à quelque kilomètres d'un émetteur.

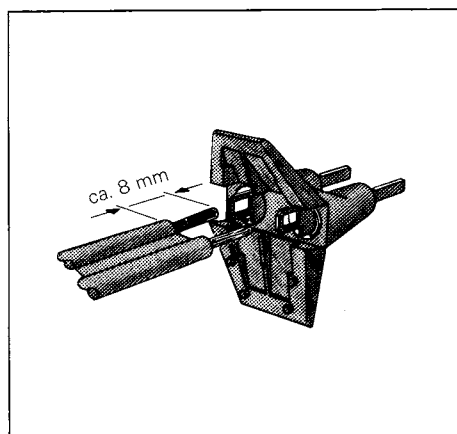

La bande des OUC se rapporte à des longueurs d'onde d'environ 3 mètres dont leur propagation ressemble à la propagation de la lumière. C'est pourquoi la réception en vue directe de l'antenne d'émission sera la meilleure. Toutefois une bonne antenne permet une réception confortable même sans vue directe de l'émetteur.

Les ondes métriques sont réfléchies par les objets fixes de dimension supérieure à leur longueur d'onde. Si l'antenne de réception reçoit à la fois l'onde directe et l'onde réfléchie, il s'en suit une distorsion de temps de transit (réceptions multiples, connues en télévision par l'apparition d'images fantômes).

Une bonne antenne directive correctement orientée élimine ces distorsions.

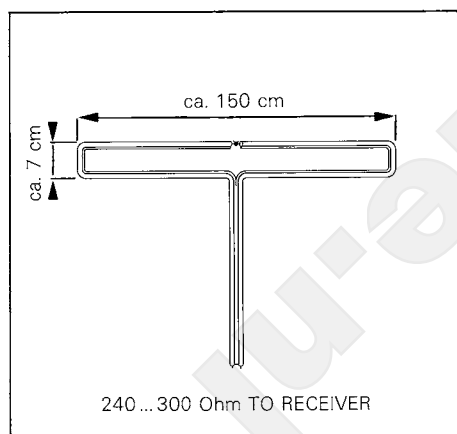

Dans le cas où une antenne ferait véritablement défaut, il resterait toujours la possibilité d'en faire une soi-même, à l'aide d'un câble plat de 240 ohms. Il s'agirait là bien sûr d'une solution de secours, pour la réception des émetteurs locaux, qui ne saurait remplacer une antenne extérieure. Normalement, ces antennes sont uniquement utilisées si l'émetteur est tout près et l'intensité du champ assez grande. Une telle antenne se monte perpendiculairement à la direction de l'émetteur.

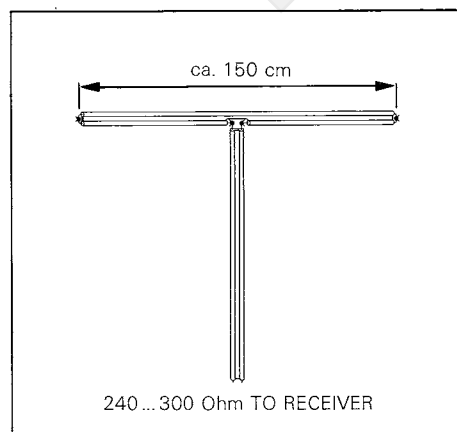

DISTORSIONS DE TEMPS DE TRANSIT DUES AUX RÉCEPTIONS MULTIPLES

MESURE DES DISTORSIONS DE TEMPS DE TRANSIT AVEC L'OSCILLOSCOPE

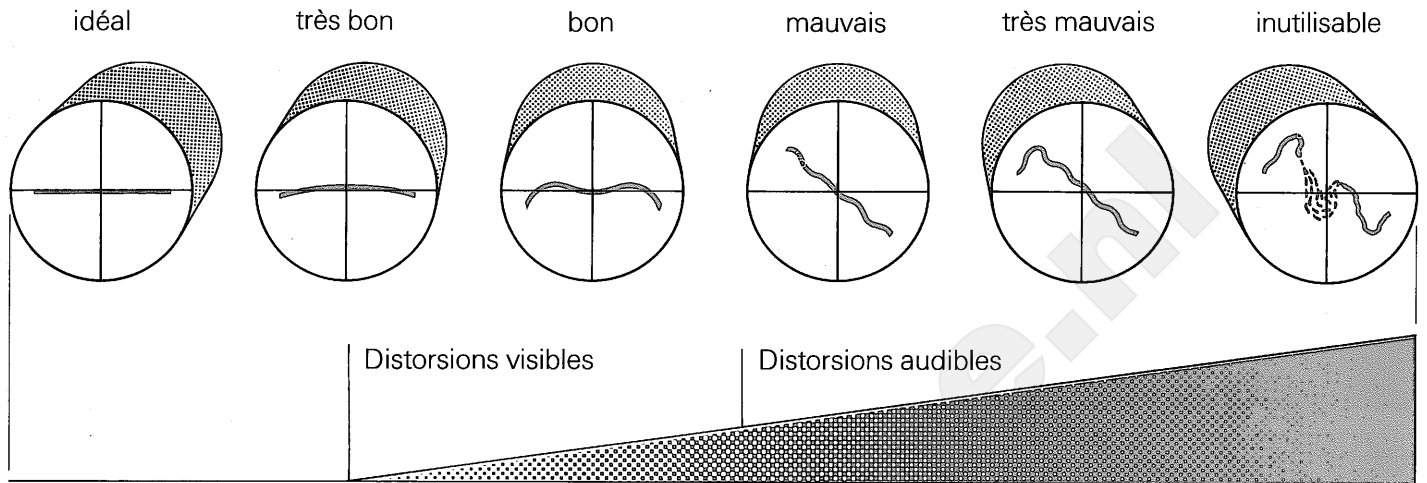

MESURE DE L'EXCURSION ET DE L'INTENSITÉ DU SIGNAL

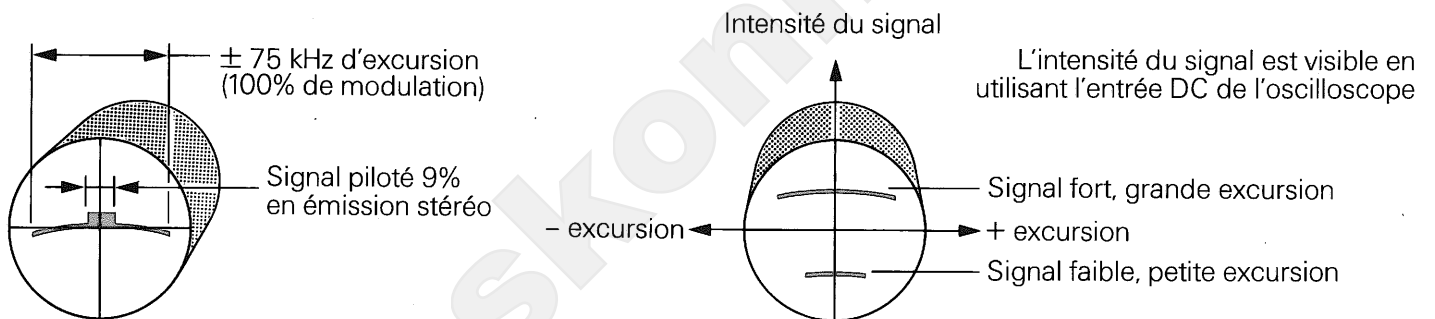

ORIGINE ET MISE EN ÉVIDENCE DES RÉCEPTIONS MULTIPLES

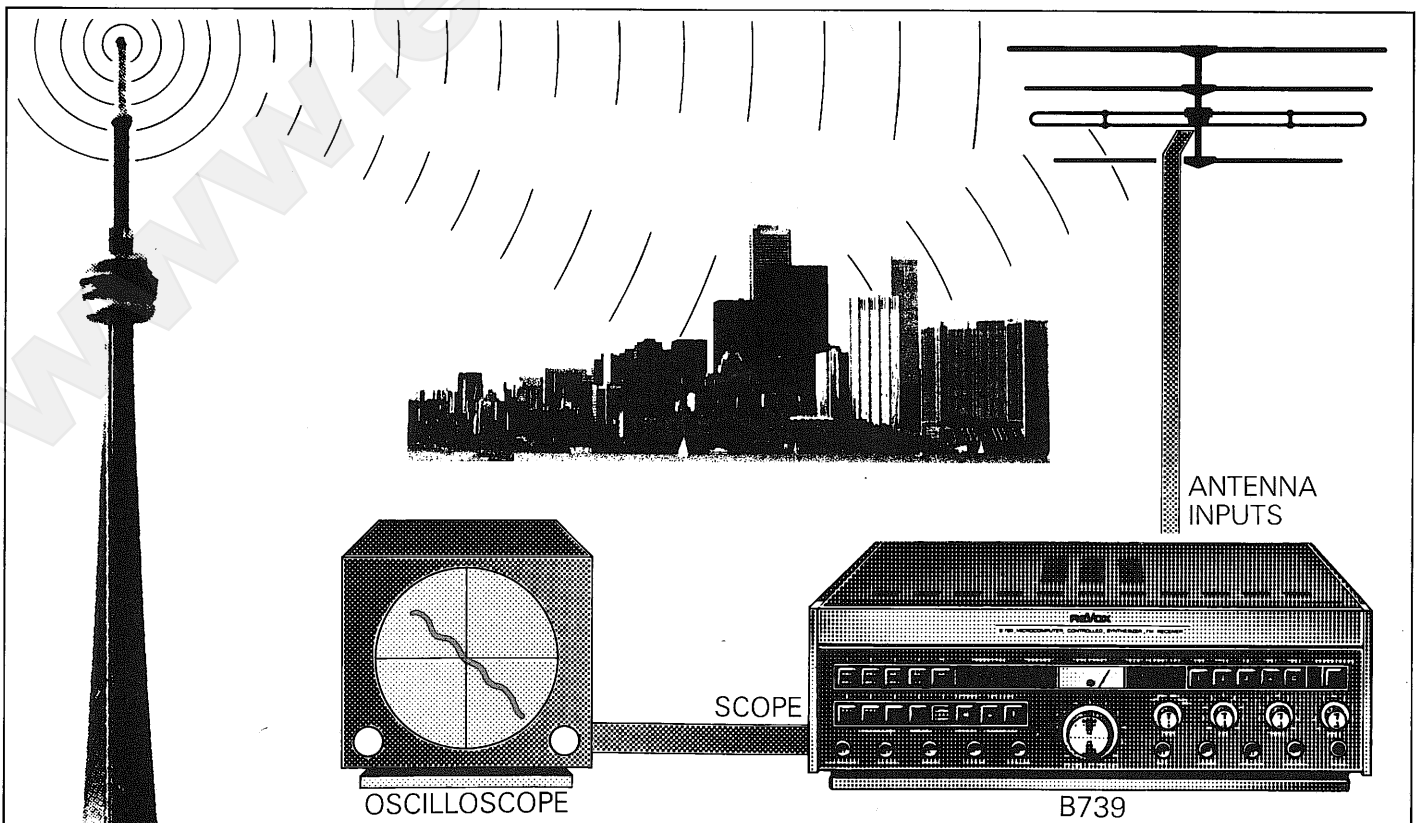

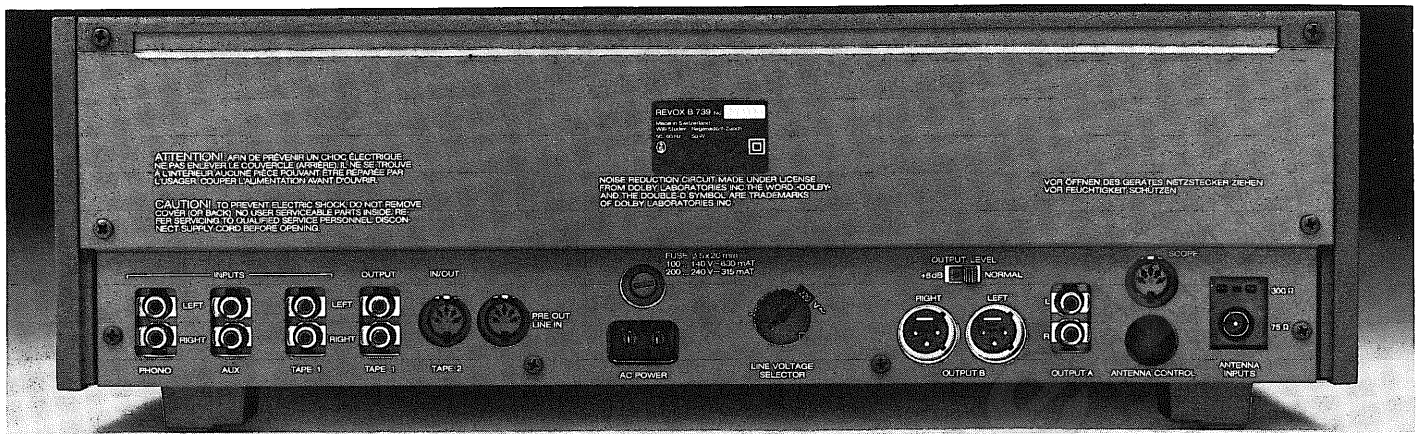

DISPOSITION DES PRISES

JACK PREAMP OUT
0,85 V/RL min. 47 ohms

JACK PHONES
11,8 V/charge optimale 200 ... 800 ohms



XLR OUTPUT B
2 V/220 ohms



DIN TAPE 2 IN/OUT
IN: 150 mV/50 kohms
OUT: 5,5 mV/RL min. 10 kohms

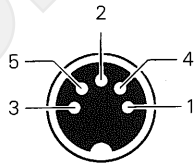

1 Sortie gauche
2 Masse, blindage
3 Entrée gauche
4 Sortie droite
5 Entrée droite

DIN PRE OUT/PWR IN
OUT: 0,85 V/RL min. 10 kohms
IN: 1 V/50 kohms

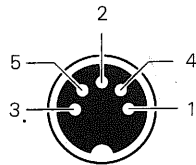

1 PRE gauche
2 Masse, blindage
3 PWR gauche
4 PRE droite
5 PWR droite

DIN SCOPE
Sortie oscilloscope:
Vertical (Y): 50 mV à 75 ohms HF \approx 1 V
Horizontal (X): 75 kHz d'excursion \approx 2,8 V_{pp}
Prise selon DIN 41524

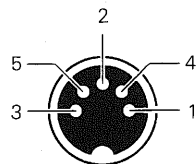

1 Axe X
2 Masse
3 Axe Y
4 Commande d'enclenchement
5 Commande d'enclenchement

CÂBLES D'INTERCONNEXIONS

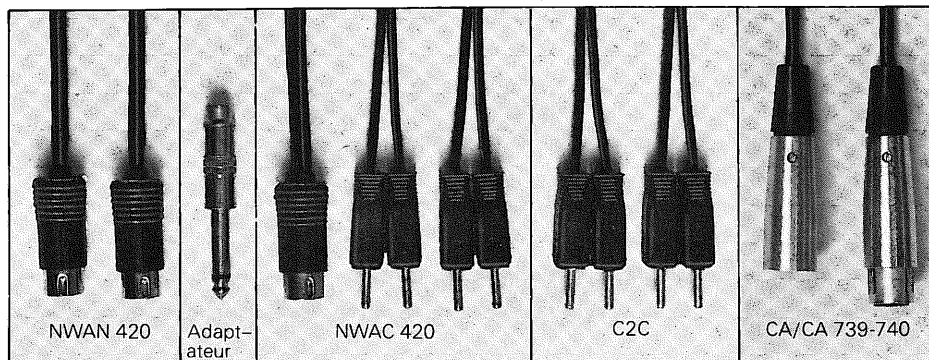

- NWAN 420, 2 m, fiche 5 pôles DIN aux deux bouts, enregistrement/lecture stéréo Art. no 33092
- Adaptateur Cinch femelle/Jack Art. no 33405
- NWAC 420, 2 m, 2x double Cinch/DIN, enregistrement/lecture stéréo Art. no 33082
- C2C 210, 1 m, double Cinch aux deux bouts, 2 canaux Art. no 33041
- C2C 220, 2 m, double Cinch aux deux bouts, 2 canaux Art. no 33042
- CA/CA 739-740 1 m, Cannon (XLR) aux deux bouts, 1 canal Art. no 33211

OPERATING INSTRUCTIONS REVOX B739

PACKING MATERIAL

Do not destroy the original packing. If you ever have to transport your equipment, this special packing will provide the best possible protection.

IMPORTANT NOTES

Protect the equipment from excessive heat and humidity. Install it in a manner which ensures the free convection of air through the ventilating louvers. There are no user serviceable parts inside the equipment, however, should it become necessary to open the unit, it must first be disconnected from the electric current supply. Be sure to operate the unit on alternating current systems (a.c. 50 ... 60 Hz) only. Different supply voltages can be accommodated by adjusting the voltage selector on the back of the unit to one of the following settings:

STATION	FREQUENCY	UPPER1		2		3
STATION	FREQUENCY	LOWER1		2		3
		4		5		6
		4		5		6
		7		8		9
		7		8		9

Printed in Switzerland
 by WILLI STUDER 18.631.980
 Copyright by WILLI STUDER
 CH-8105 Regensdorf-Zurich

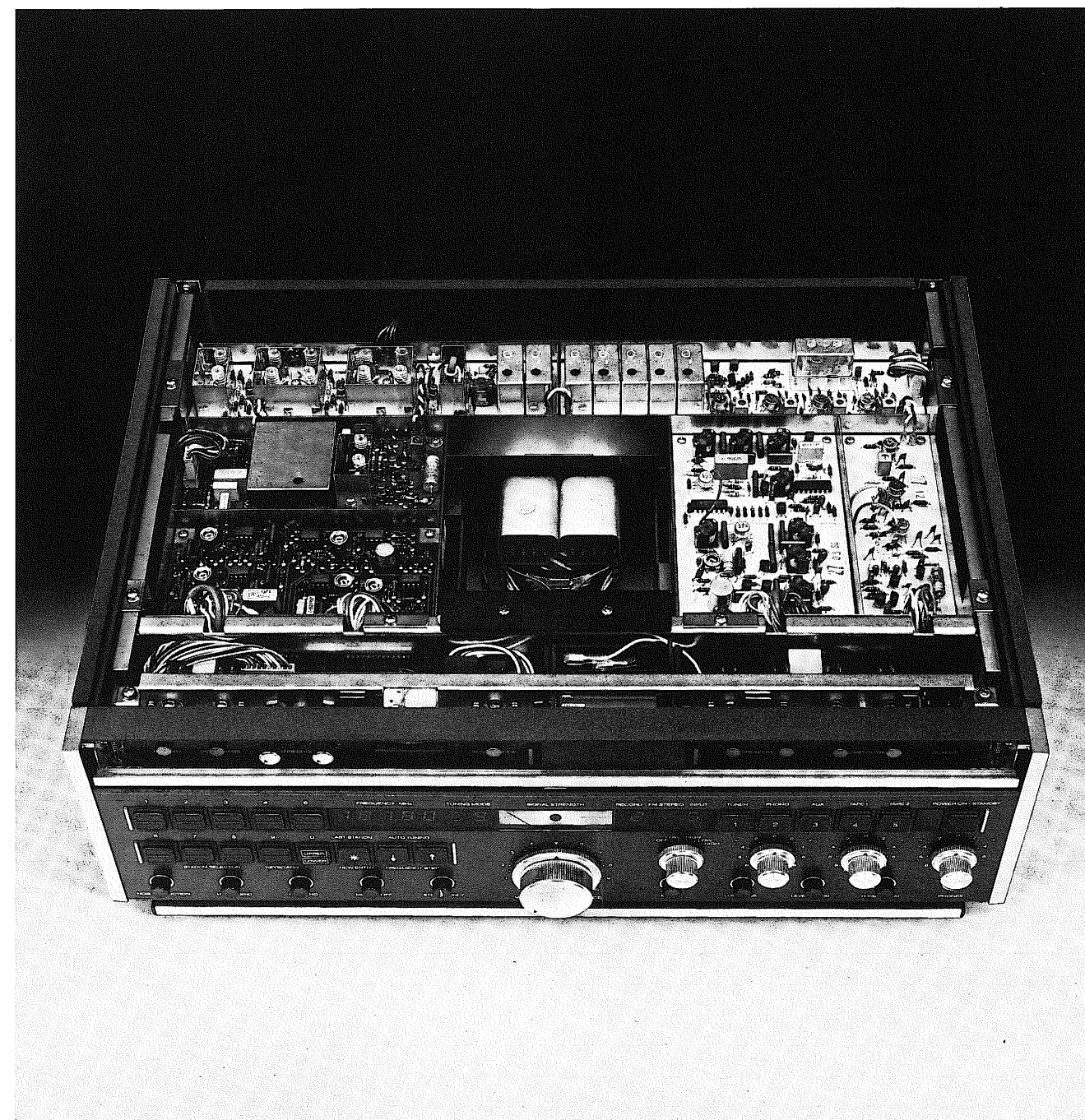

Please fold out this page

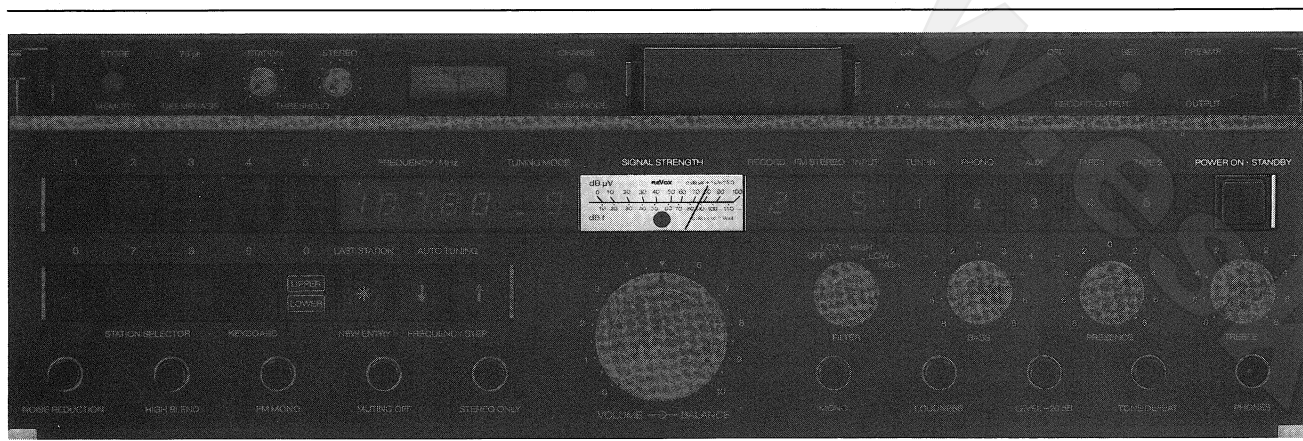

SWITCHING ON, ELECTRIC CURRENT SUPPLY, RECHARGEABLE BATTERIES FOR STATION MEMORY



TUNING SECTION, STATION MEMORY, AUTOMATIC TUNING



INPUT SELECTION, OUTPUT SWITCHING, OUTPUTS ON THE FRONT PANEL



VOLUME, BALANCE, TONE CONTROL, FILTER

www.eskon.fi



NOTE:

In order to get acquainted with the operation of the B739 Tuner · Pre-amplifier as quickly as possible, we suggest that you read carefully the steps described on pages 2 to 16 of this operating manual while simultaneously performing each manipulation.

CONNECTIONS/PUTTING INTO SERVICE

2

OPERATING THE TUNER SECTION

Automatic tuning	5
Entering station frequencies into the memory	7
Recalling station frequencies	8
Entering a station's known frequency	9
Stereo reception	10
Manual tuning	12
Noise reduction	12

OPERATION OF AMPLIFIER SECTION

Selecting the signal source/input selection	13
Making a tape recording	14
Tone control	15
Filter	16
Other functions of the amplifier section	16
Additional technical data	17

SUNDRIES

Organization of the station memory	17
Warranty conditions	17
FM antennas	18
Multipath distortion	19
Wiring of sockets	20
REVOX interconnecting cables	20
REVOX music system, functional diagram	inside back cover

CONNECTIONS/PUTTING THE UNIT INTO SERVICE

Lower the front flap

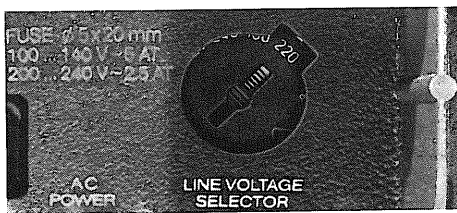
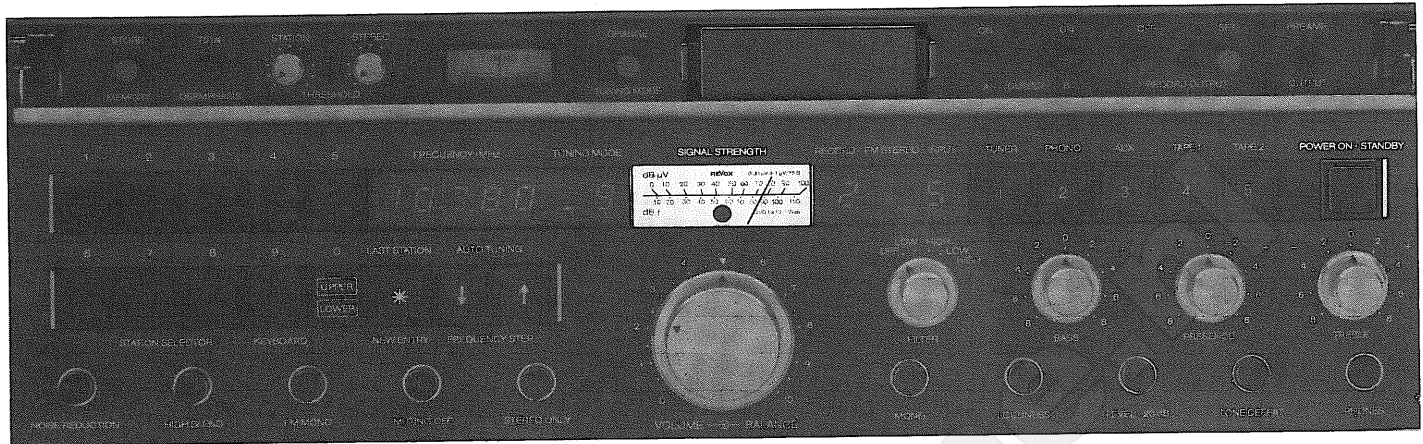

CHECK THE SETTING OF THE VOLTAGE SELECTOR
If necessary, adjust to match local supply voltage.

Electric current supply: 100, 120, 140, 200, 220, 240 Volts AC $\pm 10\%$, 50 ... 60 Hz
Power consumption: 50 Watts max.

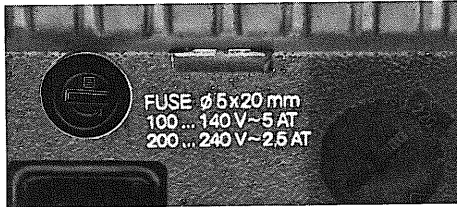

CHECK PRIMARY POWER FUSE
For 100 ... 140 Volts: 630 mA slow-blowing
For 200 ... 240 Volts: 315 mA slow-blowing

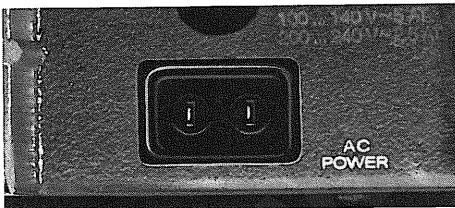

CONNECT ELECTRICAL POWER CORD
Use only the power cord supplied with the unit

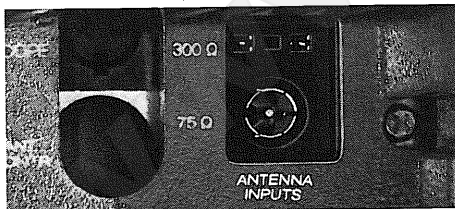

CONNECTING THE ANTENNA
75 Ohms with coax plug or
300 Ohms symmetrical twin-lead with flat plug

Preference should be given to the coaxial input: It provides not only superior screening against electrical interference, it also avoids a 0.5 ... 1.5 dB loss in signal strength which would be caused by the otherwise necessary balun (balanced to unbalanced transformer).
See also page 18

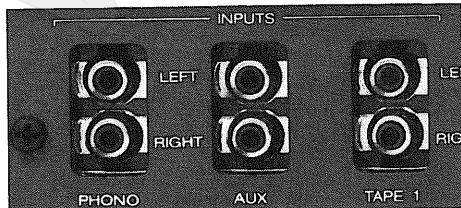

CONNECTING THE SIGNAL SOURCES Refer also to page 20 and to the inside back cover.
PHONO: Turntable with magnetic pick-up cartridge
Input sensitivity: 3 mV/47 kOhms, 220 pF (for .2 V output voltage). Signal-to-noise ratio > 82 dB (ref. 5 mV, A-weighted). Phono equalization (new RIAA) ± 0.5 dB 20 Hz ... 20 kHz.
AUXiliary input: (for LW/MW/SW radios etc.)
TAPE 1: Tape recorder 1
AUX, TAPE: sensitivity for 2 V: 150 mV/50 kOhms. Signal-to-noise ratio: > 90 dB

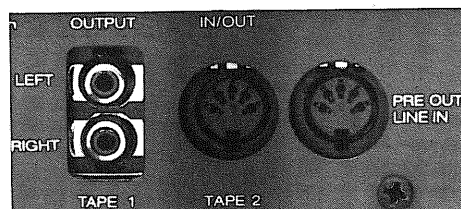

TAPE 2: Tape recorder 2 or cassette recorder (5 pin DIN socket)

NOTE:
The red shorting plugs must remain connected to all unused input sockets!
These shorting plugs improve the amplifier's signal-to-noise and crosstalk performance.
Crosstalk attenuation (at 1 kHz): all inputs > 70 dB

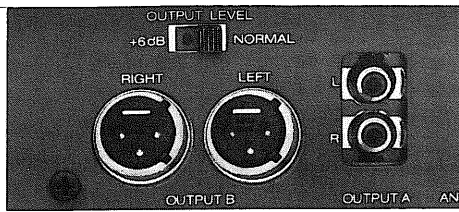

CONNECTING THE POWER AMPLIFIERS

OUTPUT A: Cinch connectors

OUTPUT B: XLR connectors

Output voltage: 2 V; output impedance: 220 ohms

OUTPUT LEVEL: Allows to increase the output voltage to 4 V

+6 dB correspond to a voltage ratio of 2 (doubling); to be used to drive insensitive power amplifiers



CONNECTING HEADPHONES

Headphones with an impedance rating of 8 Ohms or more per system are suitable.

The headphone output remains active, independent of the selected power amplifier output.

Stereo jack: 11.8 Volts/optimal load 200 ... 800 Ohms

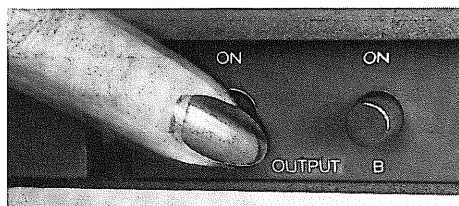

SELECTING THE DESIRED POWER AMPLIFIER OUTPUT

Button A: Cinch output

Button B: XLR output

A + B: Both outputs simultaneously

Headphone monitoring is possible even with both outputs switched off.

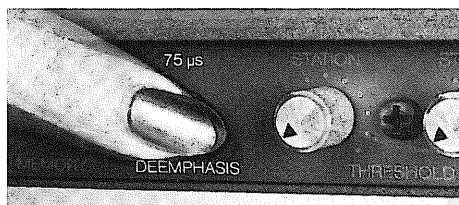

DEEMPHASIS

For USA: 75 μ s

For all other countries: 50 μ s

button depressed

button released

With noise reduction electronics inserted and the button NOISE REDUCTION depressed, a 25 μ s deemphasis is in effect.

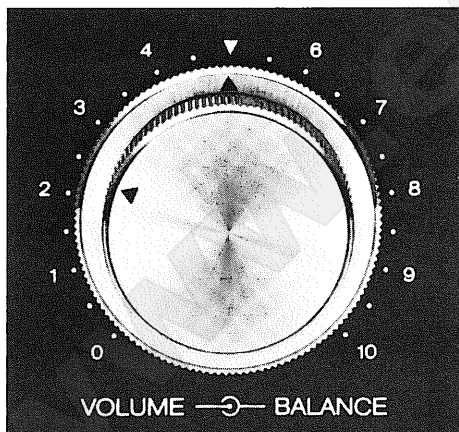

VOLUME CONTROL

Set to number 2 approximately

BALANCE

Set to center position

For correct loudness control, refer to page 16.

Balance control: To compensate for unbalanced stereo reproduction due to unsymmetrical speaker placement, or possible other differences in loudness between the two channels.

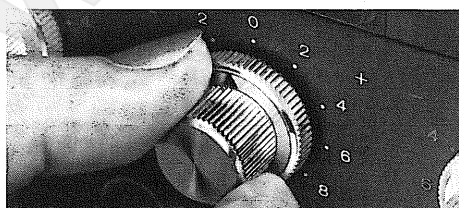

TONE CONTROLS SET TO CENTER POSITION

For additional information see page 15



FILTERS SWITCHED OFF

For additional information see page 16

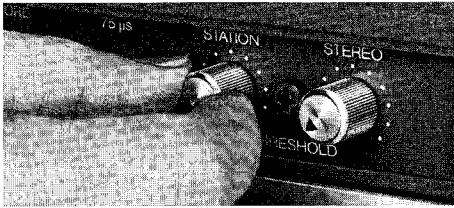

THRESHOLD CONTROLS STATION AND STEREO SET TO MINIMUM
Knob turned fully counterclockwise.

Switching threshold STATION: 17.3 ... 37.3 dBf
Threshold level for STEREO reception: 25.2 ... 65.2 dBf



BOTTOM ROW OF ALL CIRCULAR PUSHBUTTONS SWITCHED OFF

Locking buttons: Push on/push off.



INSERT RECHARGEABLE BATTERIES

The electronic station memory remains powered even with the receiver switched off.

To avoid loss of the stored station frequencies in case of a power line failure, it is necessary to install the three rechargeable batteries (type IEC KR 15/51) which are supplied with the unit.

PRESS THE LATCHES TOWARDS EACH OTHER AND PULL OUT THE BATTERY COMPARTMENT

Remove paper insert.

Place batteries into the compartment by observing correct polarity. The correct positioning of each battery is shown on the inside bottom of the compartment.

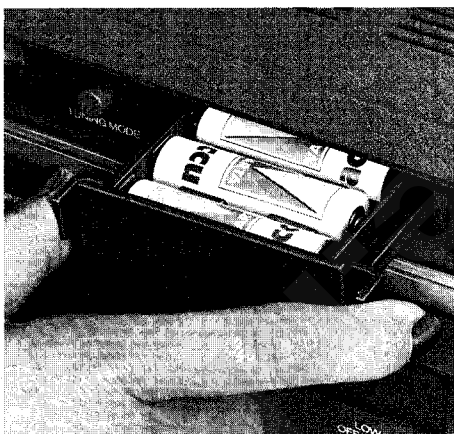

IMPORTANT:

Do not use normal dry batteries (alkaline or others) as they may cause damage.

CLOSE BATTERY COMPARTMENT BY PUSHING IT HOME UNTIL THE LATCHES SNAP INTO PLACE

CHARGING of the batteries takes place as long as the receiver remains connected to the electric current supply, irrespective of whether it is switched on or off.

DISCHARGED BATTERIES will be fully charged in 3 days approximately. Overcharging is not possible, because the charging current is kept at a very low value.

POWER LINE FAILURE: Fully charged batteries will maintain the stored information for one week approximately.

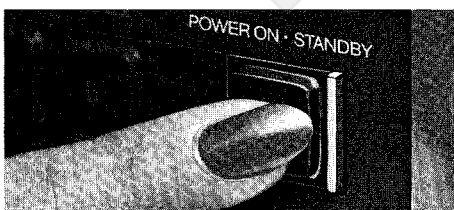

CONNECT POWER CORD TO AN ELECTRIC CURRENT OUTLET
PUSH-BUTTON POWER TO SWITCH ON THE RECEIVER

The Power switch is of the push on/push off type. By pressing it a second time, the unit will be switched off again.

WHEN SWITCHING ON, THERE WILL BE A DELAY OF 3 SECONDS BEFORE THE RECEIVER IS FULLY OPERATIONAL



SIGNAL STRENGTH meter:

When switching on, this meter becomes illuminated.

When putting the receiver into service for the first time, the digital displays will indicate an undefined operating status.

After having operated the receiver once, the next time it is switched on again, the display will show the last used station memory position, and the last used inputs will become activated again.

OPERATING INSTRUCTIONS FOR THE TUNER SECTION

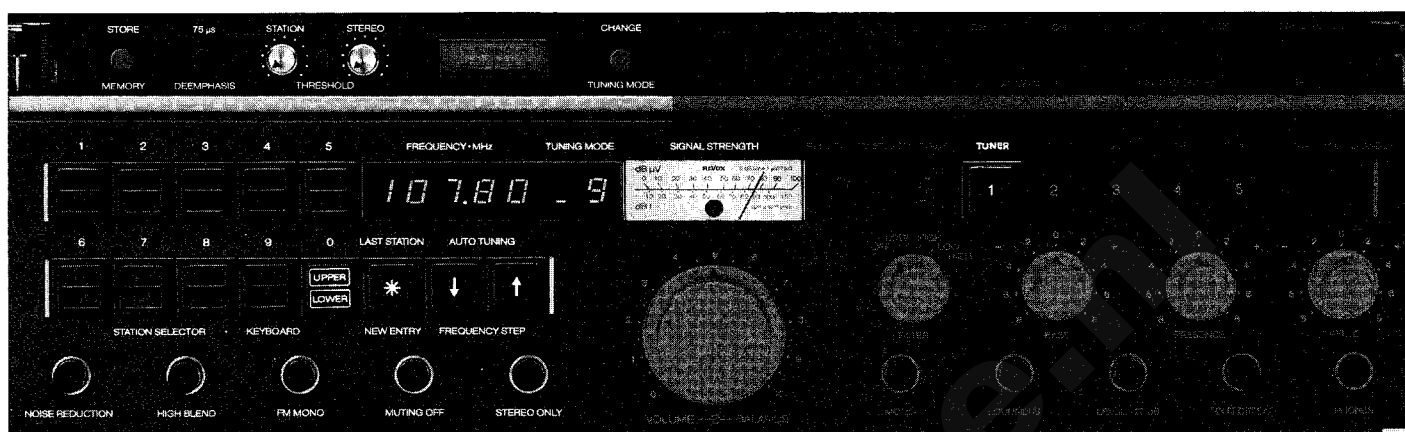

NOTE:

The controls which have to be operated are shown by the illustrations on the left-hand side.

The operating statuses as indicated by the displays, after having selected a certain operating mode, are shown by the illustrations on the right-hand side. The frequencies shown in these instructions (FREQUENCY · MHz) are not necessarily usable station frequencies. Ask your dealer for a list of stations and their frequencies in your region.

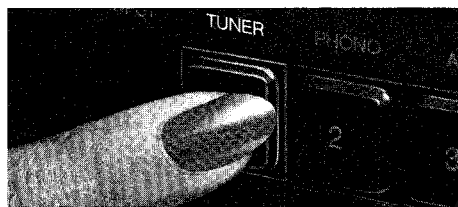

Press the button TUNER. The INPUT display will show <1>. This means that the tuner's output is now connected to the amplifier.

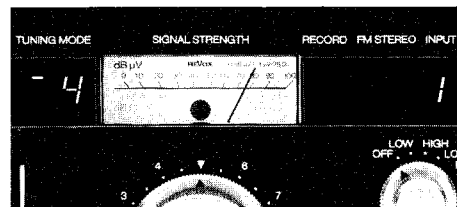

AUTOMATIC TUNING

The automatic tuning sequence scans the complete tuning range from 87.5 through to 107.95 MHz in 100 kHz steps. Exact tuning to any station of sufficient signal strength will then occur with a 50 kHz resolution (e.g. 89.850 MHz).

ATTENTION:

Immediately after switching on the receiver, the display TUNING MODE will show any number from 1 to 9.

If an <F> (frequency entry) is displayed due to one of the manipulations described later, press the button CHANGE TUNING MODE to return to the auto tuning sequence.

EXAMPLE FOR THE PRECISE TUNING TO A STATION'S FREQUENCY

Auto tuning commences at the frequency in the display. If the display is not illuminated, tuning starts at 87.50 (up) or 107.95 (down).

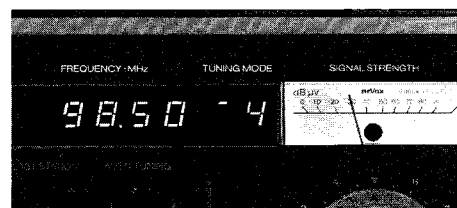

Assuming the display shows the frequency of 98.50 MHz:

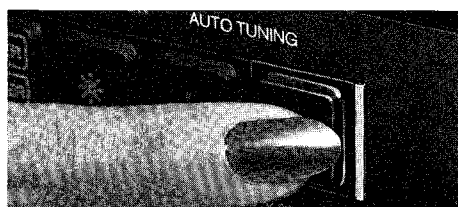
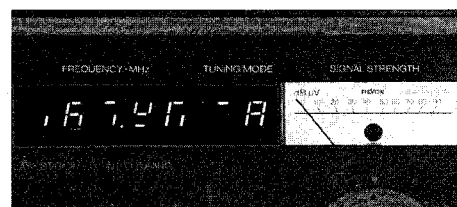

Briefly press the button AUTO TUNING ↑
The frequency display will count from that frequency on upward.

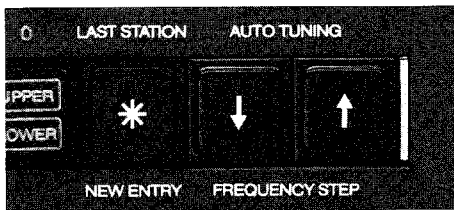

FREQUENCY DISPLAY STOPPED
A station transmitting at 98.80 MHz is tuned in with quartz precision.

Tuning accuracy: $\pm 0.0025\%$.

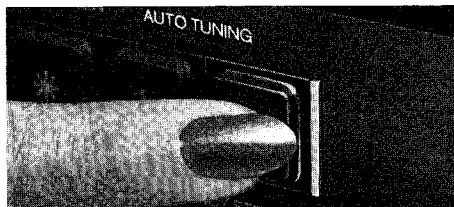

AUTO TUNING ↑
counting upwards

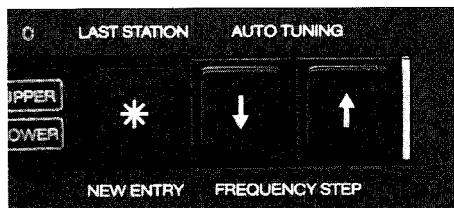
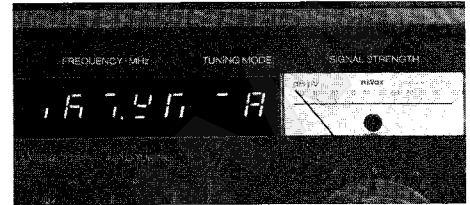

A station transmitting at 99.10 MHz is being received.

SIGNAL STRENGTH meter:
0 ... 100 dB μ V (0 dB μ V \triangleq 1 μ V/75 Ohms)
10 ... 110 dBf (0 dBf \triangleq 10⁻¹⁵ W)

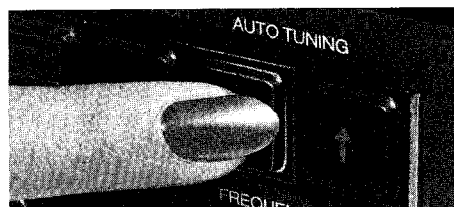
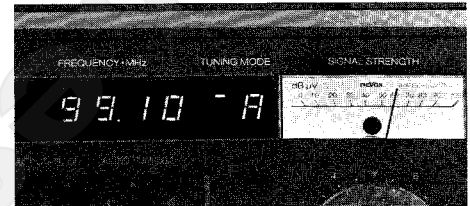

AUTO TUNING ↓
counting downwards

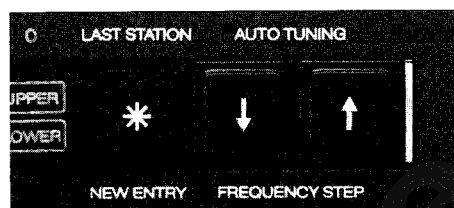
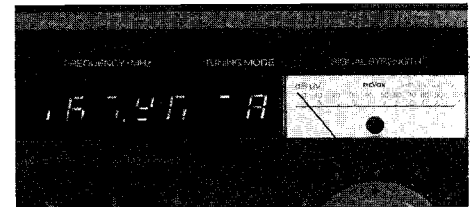

The station transmitting at 98.80 MHz is now tuned again in.

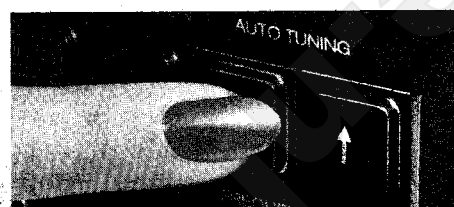
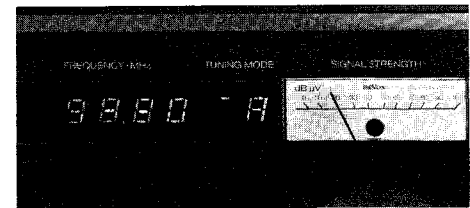

By keeping one or the other button **AUTO TUNING** depressed, tuning can be speeded up in the desired direction.

No station will be tuned in as long as the button is held depressed. When releasing the button, normal **AUTO TUNING** continues until another station is received.

Additional technical data of the tuner section:

Image rejection:	106 dB; $f_s = 2 \times f_{IF}$
IF rejection:	110 dB; f_{IF}
Spurious response ratio:	106 dB; $f_s = f_{IF}/2$
Capture ratio at 65 dBf:	2 dB
Selectivity, adjacent channel:	16 dB average
Selectivity, alternate channel:	78 dB average
AM suppression:	70 dB referred to 75 kHz deviation, 30% AM 400 Hz and 1 mV antenna signal on 75 Ohms
Frequency response:	30 Hz ... 15 kHz ± 1 dB measured with 40 kHz deviation and 1 mV antenna signal on 75 Ohms
Total harmonic distortion at 65 dBf:	0.25% at 1 kHz stereo

**ENTERING A STATION'S
FREQUENCY INTO THE MEMORY**

Any frequency as shown in the FREQUENCY · MHz display may be entered into one of the 18 station memories. The numbers (addresses) of the memory positions are shown in the display TUNING MODE. A horizontal bar ahead of the number identifies the memory bank: Bar in upper position — for memory bank 1 ... 9 UPPER, bar in lower position _ for memory bank 1 ... 9 LOWER. Each memory position is identified as follows:
 UPPER: —1, —2, —3, —4, —5, —6, —7, —8, —9
 LOWER: _1, _2, _3, _4, _5, _6, _7, _8, _9 (see also page 17)

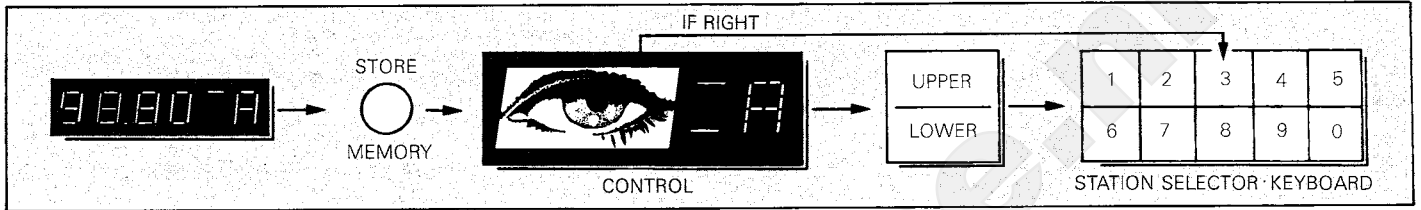

PROCEDURE FOR MEMORY ENTRY

EXAMPLE:

Enter into position 4 UPPER (—4) the frequency of the station just tuned in by AUTO TUNING.

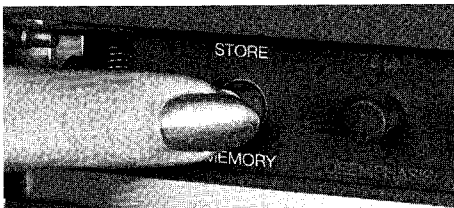

Press button STORE MEMORY

«A» flashes

The flashing will end after approximately 20 seconds if no station key is operated during that time.



CONFIRM DESIRED MEMORY BANK (UPPER/LOWER)

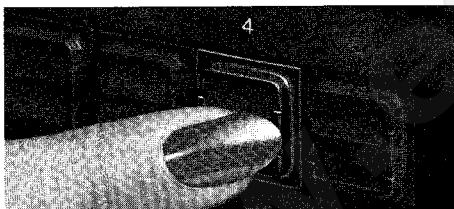

Press STATION SELECTOR «4»

The frequency of 98.80 MHz is now stored in memory —4 (4 UPPER).

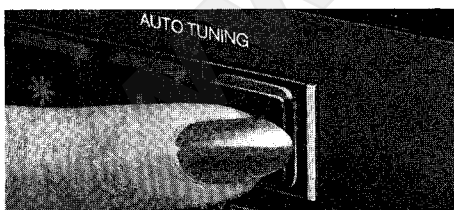
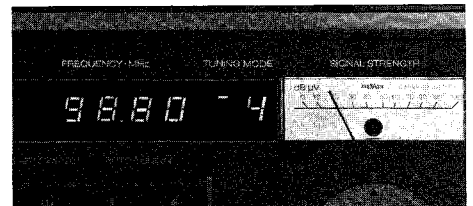

Find another station in the AUTO TUNING mode and enter its frequency into 2 LOWER (_2):

AUTO TUNING ↑

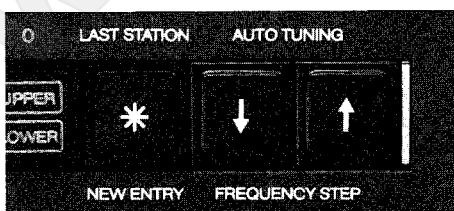
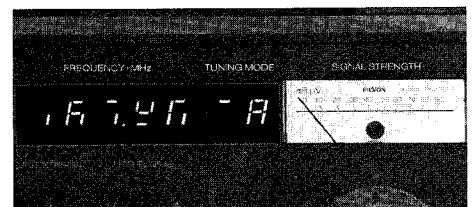

99,10 MHz

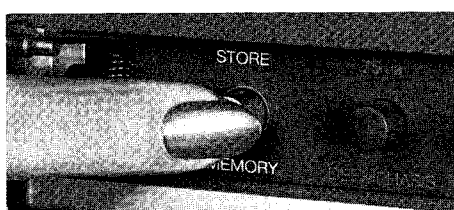
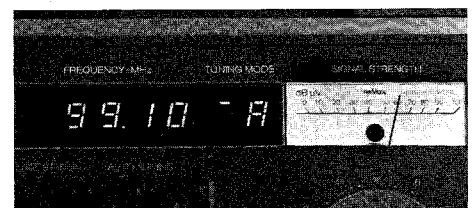

STORE MEMORY

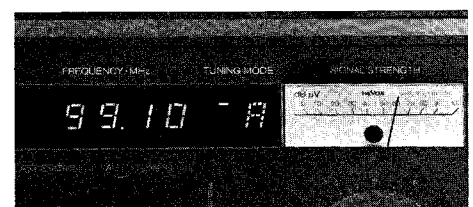

CONFIRM MEMORY BANK

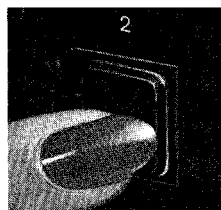
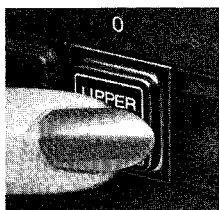

Preselect memory bank LOWER by pressing the key marked UPPER/LOWER

Press STATION SELECTOR <2>

The frequency 99.10 MHz is now stored in memory _2 (2 LOWER)

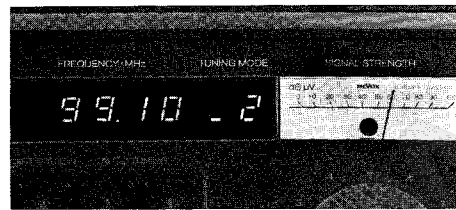

In this manner, each button of the STATION SELECTOR · KEYBOARD provides two memory positions (UPPER and LOWER), each of which may be loaded with any desired station frequency. The frequencies of stations that are not on the air while programming the receiver may be entered as well. A memory position already loaded with a station frequency can be loaded directly with another frequency without the need to cancel it first.

CANCELLATION OF MEMORY:

Cancellation of a station memory is possible at any time by entering a blank:

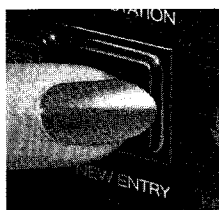

Select <F> mode by pressing the button CHANGE TUNING MODE;
Press the button NEW ENTRY followed by STORE MEMORY

CONFIRM MEMORY BANK

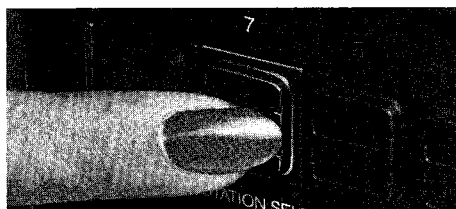
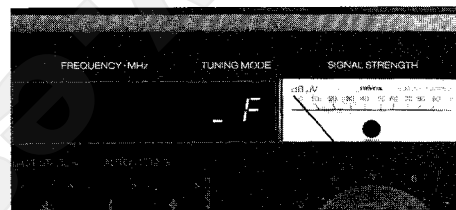

Press STATION SELECTOR <7>

Station memory _7 (7 LOWER) is now blank

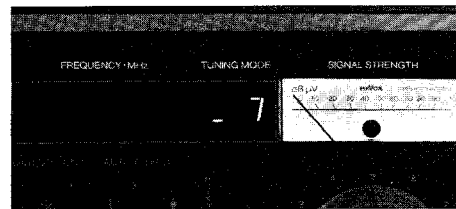

RECALLING OF STORED STATION FREQUENCIES

It is intended to receive the station stored in memory 4 UPPER (⌈ 4) ...

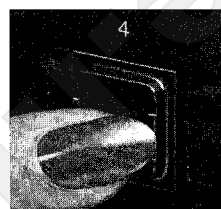
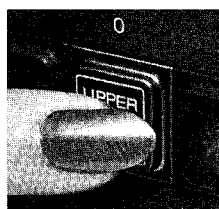

Confirm UPPER/LOWER, then press STATION SELECTOR <4>

98.80 MHz will now be received

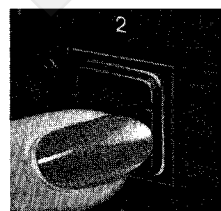
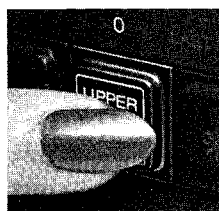
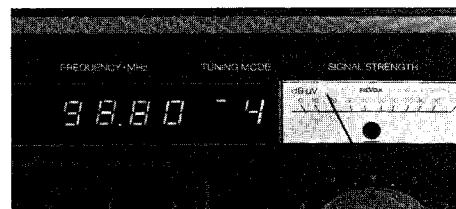

... or to receive the station stored in memory 2 LOWER (⌋ 2)

Always select UPPER/LOWER before pressing a numbered STATION SELECTOR. The illuminated bar will flash for 20 seconds or until selecting the desired number.

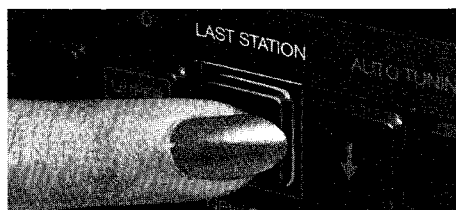
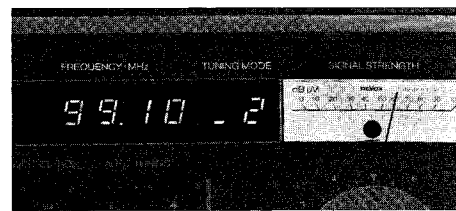

LAST STATION: This key permits the recalling of the frequency last found by AUTO TUNING and to continue auto tuning from there on.

The frequency last received by AUTO TUNING remains memorized even after the receiver has been switched off. LAST STATION also permits the quick and easy comparison of a station's (possible) second frequency found by AUTO TUNING with another frequency already stored in the memory.

Arranging the stored frequencies:

A frequency stored in one memory position (A) can be transferred directly to another memory position (B), however, in doing this, a frequency already stored in position B will be lost. How to proceed: Recall frequency (A), press the button STORE MEMORY, then select new memory position.

UNINTENTIONAL ERASURE:

Keep a log of frequencies and their memory positions for quick reentry of a lost frequency. Use the table provided on the front page.

ENTERING A STATION'S KNOWN FREQUENCY

Any frequency of the FM band – perhaps as read from your weekly program magazine – may be entered by just pressing the appropriate buttons. In a first step the TUNING MODE <F> has to be selected.

Example: Station's frequency 98.50 MHz.

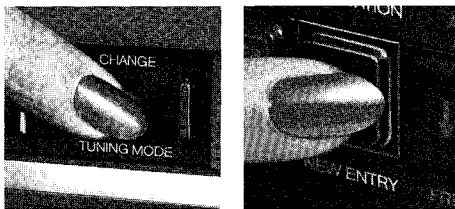

Press CHANGE TUNING MODE followed by NEW ENTRY

After having activated NEW ENTRY, the frequency display will be switched off. The tuner section is then muted.

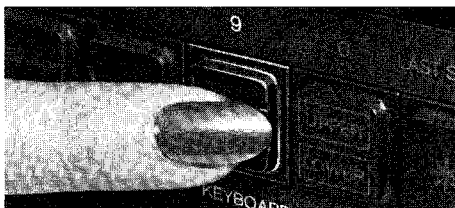
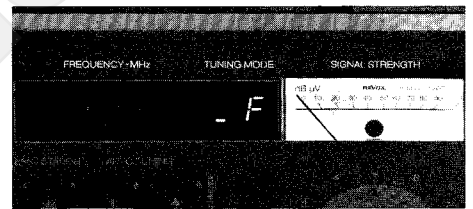

9

Decimal point appears automatically

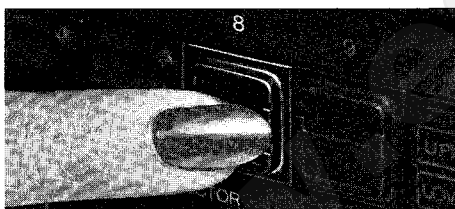
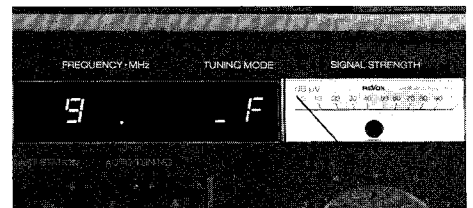

8

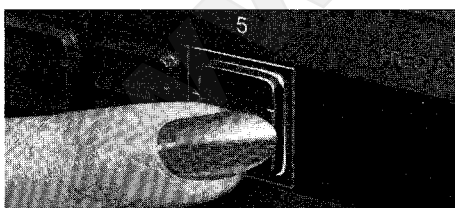
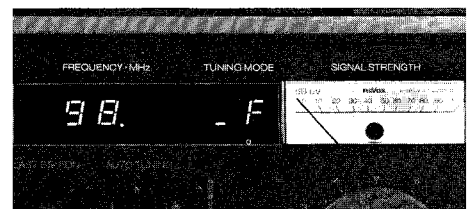

5

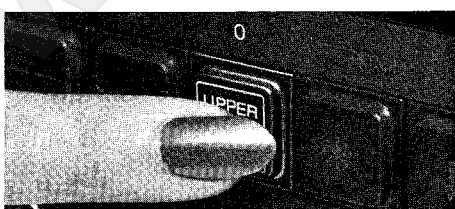
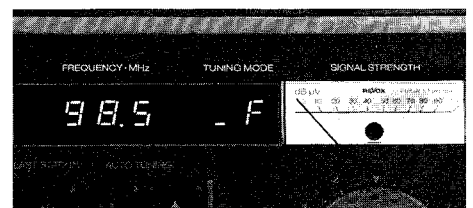

0

Stations whose frequency correspond to the 25 kHz channel pattern have to be entered to the second last digit. Example 89.125 MHz: 89.12

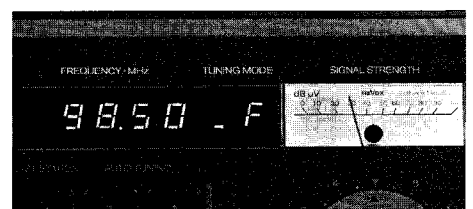

With the entry of the last digit, the received signal will be switched on.

The pointer of the SIGNAL STRENGTH meter indicates the intensity of the received signal.

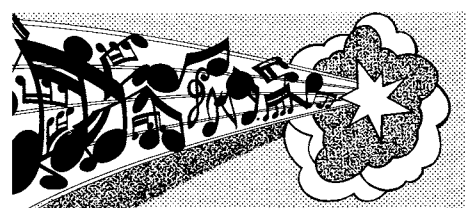

If the selected and the received frequency are identical, the pointer of the instrument TUNING will remain in the center of the meter dial.

Deviations: 20 kHz per millimeter (0.04 inches) of pointer displacement.

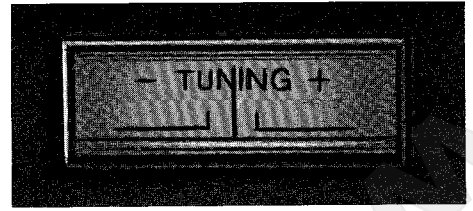

Errors when entering a frequency:

When entering frequencies outside the FM band or frequencies that do not correspond to the 25 kHz channel pattern, the incorrect digit will flash.

Example: 87.40 MHz.

By entering the correct number, the flashing will stop and the correct digit appears in the display.

Correction:

After a wrong frequency has been entered, press NEW ENTRY and start anew.

Flashing frequency display:

MUTING is activated for one of the following reasons: No station transmitting at that frequency, received signal too weak, THRESHOLD STATION set too high or station transmits monophonically, yet button STEREO ONLY depressed.

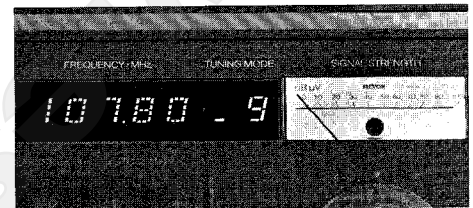
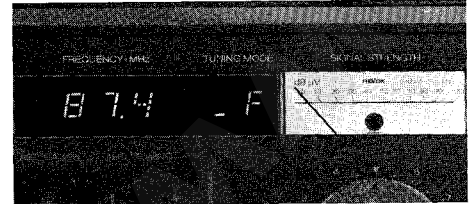

How to stop display from flashing:



Release STEREO ONLY

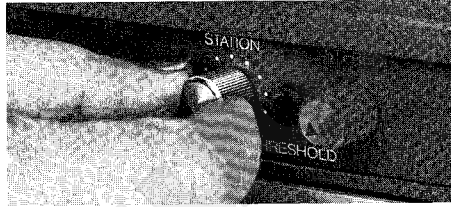

or turn THRESHOLD STATION to its counterclockwise stop

Threshold level: 2 ... 20 μ V on 75 Ohms or 4 ... 40 μ V on 300 Ohms

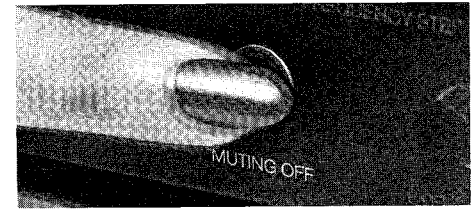

or press MUTING OFF

IHF (30 dB) useable monophonic sensitivity: 1.9 μ V/300 Ohms (10.8 dBf)

STEREO RECEPTION

Enter another frequency, say stereo station at 102.40 MHz.

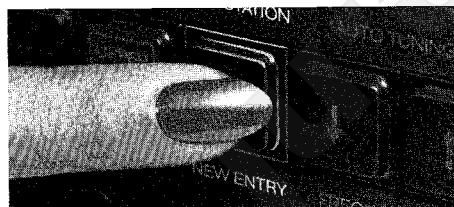

STATION SELECTOR
1, 0, 2, 4, 0

Select tuning mode (F)

NEW ENTRY

The just entered frequency will now be received.

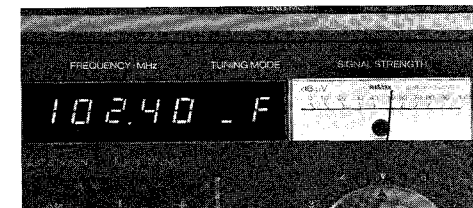
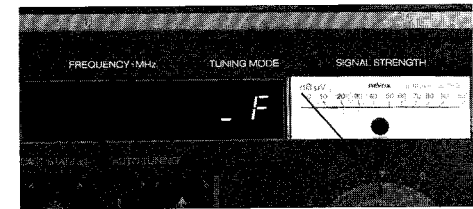

The indicator FM STEREO is illuminated.

For clean and noise-free stereo reception, the antenna signal must be higher by approximately 20 dB (10 times) as the signal strength required for comparable monophonic quality. Noisy stereo reception is usually due to insufficient strength of the received signal.

IHF (50 dB) quieting sensitivity:

Mono 2.5 μ V/300 Ohms (13.2 dBf)
stereo: 30 μ V/300 Ohms (34.8 dBf)

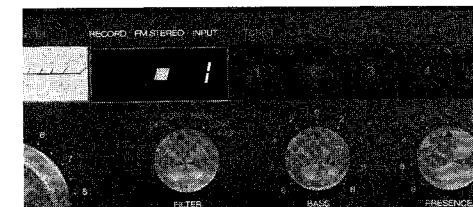

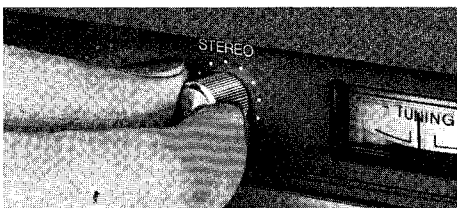

THRESHOLD STEREO

This control permits adjustment of the threshold for automatic mono/stereo switching, so that stereophonic broadcasts of sufficient signal strength only will be received.

Threshold adjustable for 5 ... 500 μ V on 75 Ohms or 10 ... 1000 μ V on 300 Ohms.



HIGH BLEND

The high background noise of weak stereo stations can be reduced by pressing this button.

Stereo separation is lessened with the result that the signal to noise performance is improved by 7 dB (at 50 μ V on 75 Ohms or 100 μ V on 300 Ohms) without affecting frequency response in any way.

HIGH BLEND released: Channel separation 42 dB at 1 kHz, 40 kHz deviation and 1 mV antenna signal on 75 Ohms.

HIGH BLEND depressed: Channel separation 10 dB.

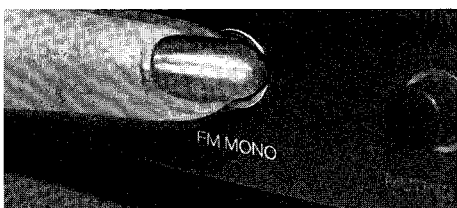

FM MONO

To receive extremely noisy stereophonic broadcasts in the monophonic mode. The two channels are no longer separated.

This push-button has no effect on the stereophonic (two channel) operation of the amplifier section.



STEREO ONLY

FM stereo stations will be received only. The signals of stations broadcasting in the monophonic mode are muted (flashing frequency display). Adjust THRESHOLD STEREO to receive signals of sufficient quality only.

Stereo stations producing a signal which is below the selected threshold level STATION will be muted as well.

Subcarrier product rejection: 72 dB.

By pressing STEREO ONLY and selecting AUTO TUNING one can quickly find all stereo stations that exceed a predetermined minimum signal strength:



Press STEREO ONLY

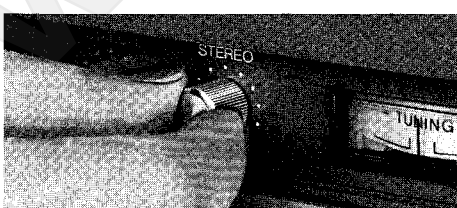

Adjust THRESHOLD STEREO

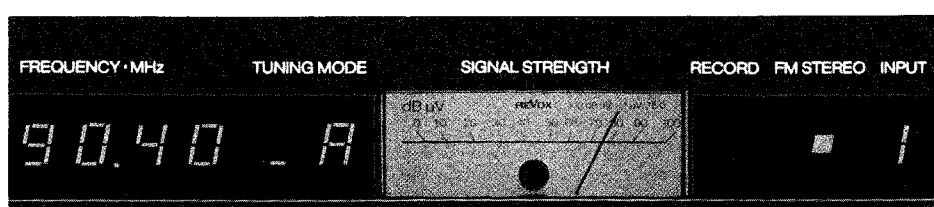
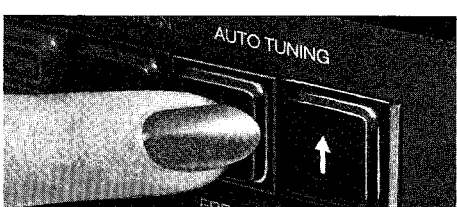

MANUAL TUNING

The whole tuning range can be scanned manually in 25 kHz steps. This is especially desirable when searching for stations whose frequency is not known precisely (or when a station previously found by auto tuning has to be tuned in accurately within the 25 kHz channel pattern, for example 89.125 MHz).

Example: A station transmitting just below 90 MHz is to be tuned in exactly:

Enter 90.00 MHz

TUNING MODE (F), NEW ENTRY, 9000

Display flashes, because no station is being received.

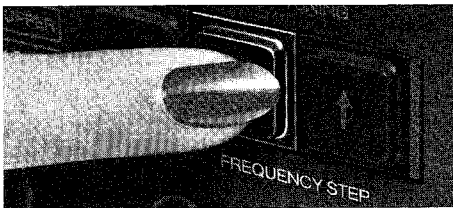
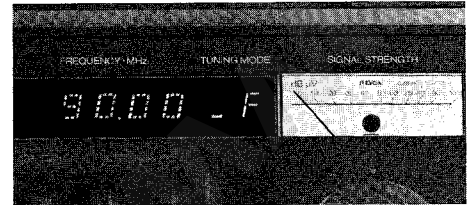

FREQUENCY STEP ↓

The SIGNAL STRENGTH meter indicates a weak signal.

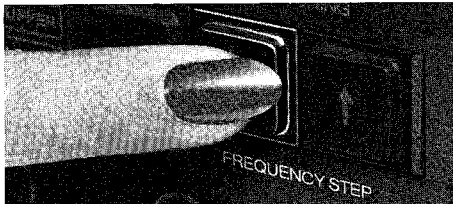
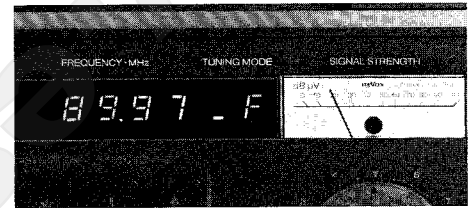

FREQUENCY STEP ↓

The pointer deflection of the meter SIGNAL STRENGTH increases.

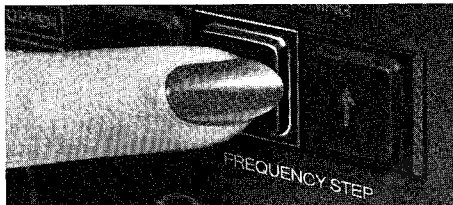
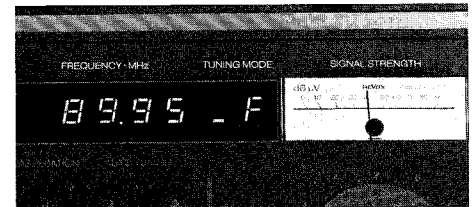

FREQUENCY STEP ↓ and so forth. By observing the meters TUNING and SIGNAL STRENGTH, exact tuning to a station's frequency is possible in a manner quite similar to the operation of receivers with a conventional tuning knob.

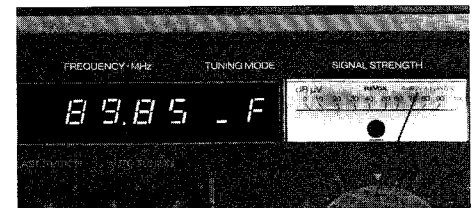

The pointer of the TUNING meter must assume exact center position.

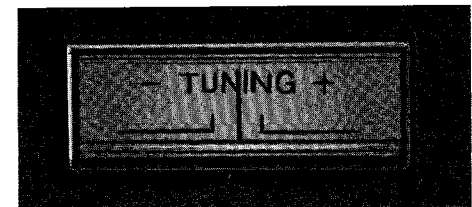

By depressing the buttons FREQUENCY STEP continuously, tuning will advance in a manner similar to AUTO TUNING, but it will stop immediately when releasing the button again.

NOISE REDUCTION

Effective only with the DOLBY® noise reduction electronics inserted.

Installation of this retrofit item is possible without the need for electrical alignment by simply replacing the dummy insert after removal of the left-hand side panel.

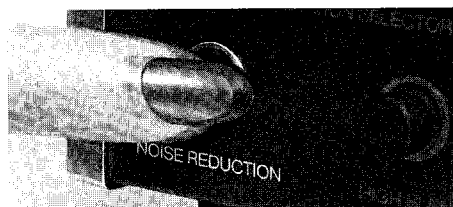

NOISE REDUCTION

The lamp in the center of the meter SIGNAL STRENGTH will be illuminated.

This button should be pressed only when receiving dolbized broadcasts, otherwise undesirable errors in the frequency response will occur.

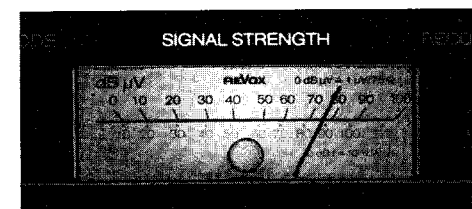

OPERATING INSTRUCTIONS AMPLIFIER SECTION



SELECTING THE SIGNAL SOURCE/ INPUT SELECTION

The input selector buttons 1 ... 5 perform a double function: The through connection of the tuner section and of the audio inputs to the amplifiers input or to the tape outputs. The selected signal sources remain stored in the memory even when switching off the receiver.

AMPLIFIER SECTION

The display INPUT signals the source which is being listened to.

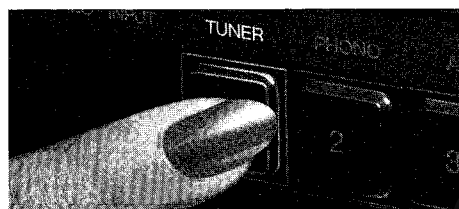

TUNER section

Audio output tuner:
15 kHz deviation/400 Hz for 70 Watts into 8 Ohms at the outputs SPEAKERS A + B.
Signal-to-noise ratio at 65 dBf:
mono 78 dB, stereo 74 dB

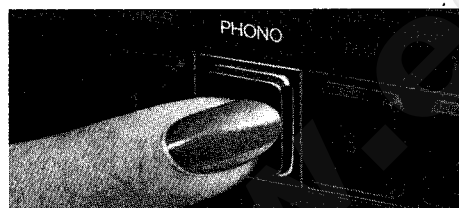
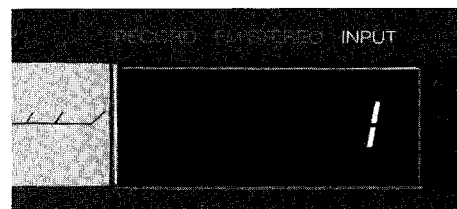

PHONO turntable

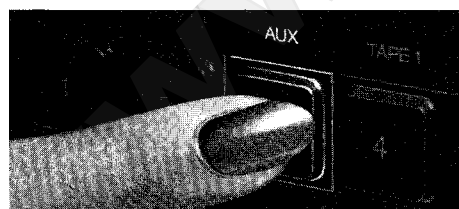
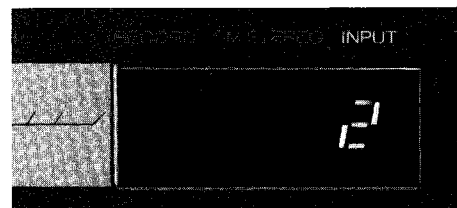

AUXiliary input for LW/MW/SW radios or other signal sources.

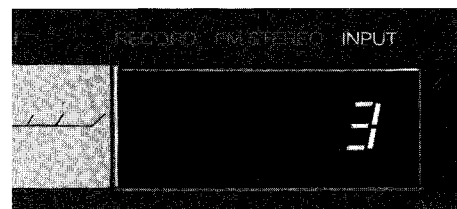

TAPE 1 tape recorder 1
Reproduction

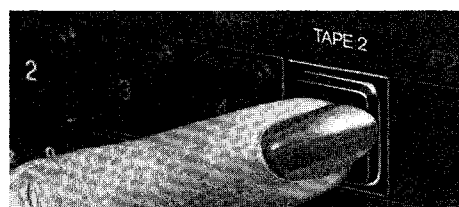
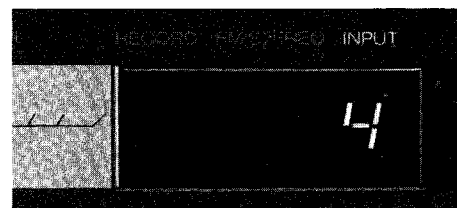

TAPE 2 tape recorder 2
Reproduction

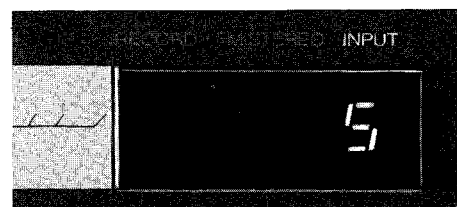

MAKING A TAPE RECORDING

The display RECORD shows the signal source (1 ... 5) which is routed to the phono sockets TAPE 1 OUTPUT and TAPE 2 OUTPUT. Selection of the signal source for recording is independent of the INPUT which is being listened to.

Example: It is intended to make a tape recording from the tuner's output.

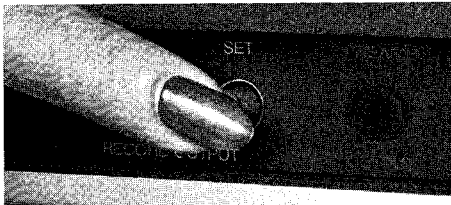

RECORD OUTPUT SET

The display RECORD will show a flashing horizontal bar or the previously displayed number will start to flash, also.

If no entry is made within 20 seconds, the flashing will stop.

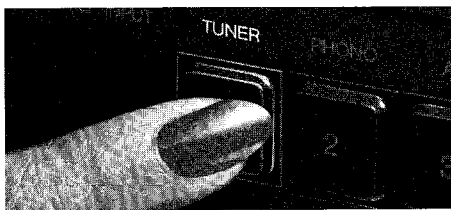

TUNER

The display RECORD shows the number 1.

A FM station's program can now be recorded on TAPE 1 while listening to the replay of TAPE 2 is possible.

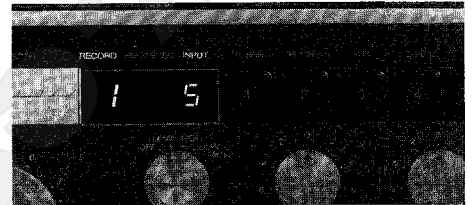

Exceptions: Input TAPE 1 (4) can be connected to output TAPE 2 only and input TAPE 2 (5) can be connected to output TAPE 1 only (risk of feedback howl). RECORD selection is inhibited during AUTO TUNING.

Output levels:

TAPE 1 (phono socket): $135 \text{ mV/R}_{L \text{ min.}} = 47 \text{ kOhms}$, TAPE 2 (DIN socket) $5.5 \text{ mV/R}_L = 10 \text{ kOhms}$.
Audio output tuner: 75 kHz deviation/400 Hertz result in 0.7 Volts on TAPE 1.

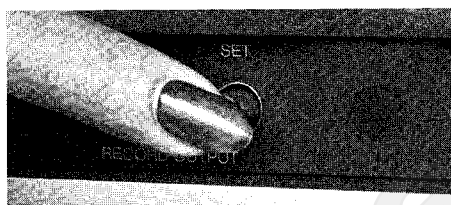

Cancellation (muting) of tape outputs:

RECORD OUTPUT SET

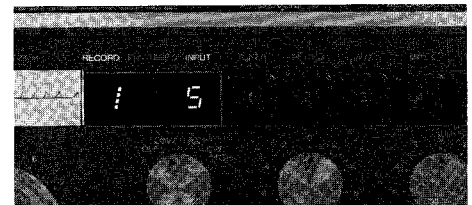

RECORD OUTPUT OFF

The outputs TAPE can be muted when not in use.

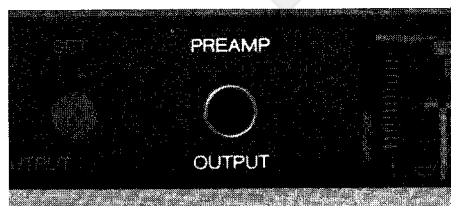
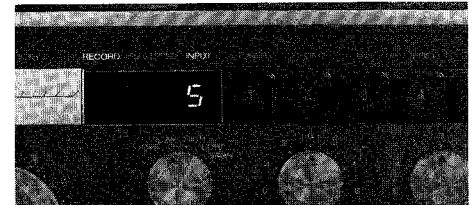

ADDITIONAL OUTPUTS:

PREAMP OUTPUT

Stereo phone jack
Preamplifier output

Output voltage $0.85 \text{ Volt/R}_{L \text{ min.}} = 47 \text{ kOhms}$

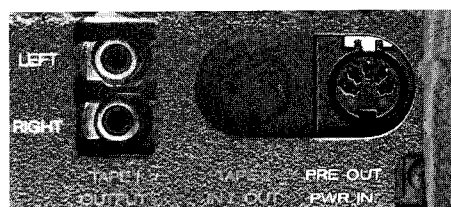

PRE OUT

DIN socket (stereo)

Output level: $0.85 \text{ Volts/R}_{L \text{ min.}} = 10 \text{ kOhms}$

PWR IN

Power amplifier input

1 Volt/50 kOhms

Note:

When inserting a DIN plug into this socket, preamplifier and power amplifier will automatically become disconnected from each other. This makes it possible to connect at this junction point filters, equalizers and other signal processing equipment.

TONE CONTROLS/FILTER



TONE CONTROL

The tone controls are effective in both channels simultaneously.

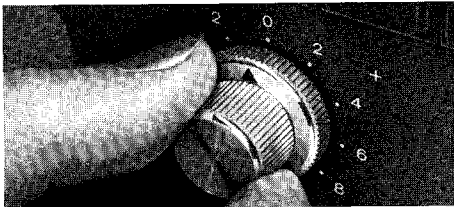

BASS control

± 8 dB at 120 Hz

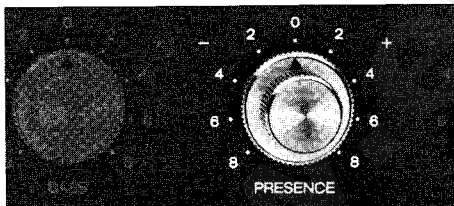

PRESENCE control (upper midrange)

± 8 dB at 3 kHz

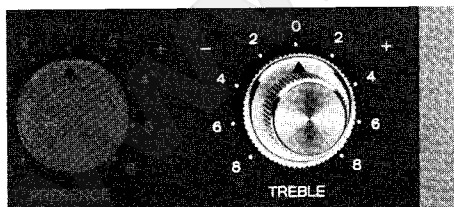

TREBLE control

± 8 dB at 8 kHz

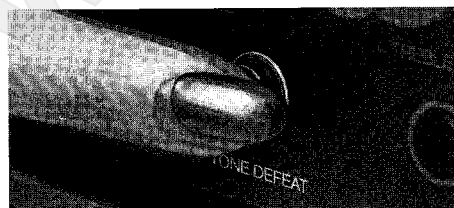

TONE DEFEAT

Bridges all tone controls, results in linear frequency response.

The filters LOW/HIGH are not bypassed.

FILTER

The filters are effective in both channels simultaneously
Position LOW: Rumble filter, attenuation of low frequencies
Position HIGH: High frequency filter, noise filter, attenuation of high frequencies
Position LOW/HIGH: Rumble- and high frequency filter combined in circuit



LOW

50 Hz, -3 dB (12 dB/octave)

HIGH

8 kHz, -3 dB (12 dB/octave)

ADDITIONAL FUNCTIONS OF THE AMPLIFIER SECTION

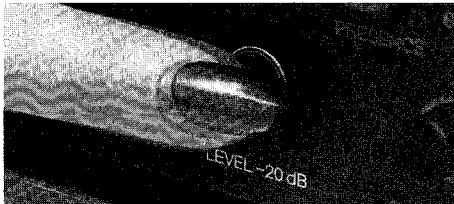

LEVEL -20 dB

Volume reduction by 20 dB. Linear attenuation of the loudness (volume) to 25% of the level as set by the volume control.

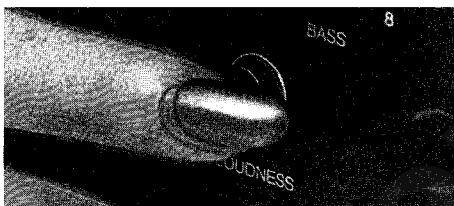

LOUDNESS

Volume control adjusted for equal loudness contour.

At -40 dB (position 4 approximately): 100 Hz +5 dB, 10 kHz +6 dB.

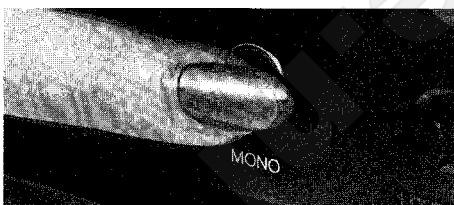

MONO

Monophonic reproduction.

The left and right channel of the amplifier section are connected in parallel. This switch remains without effect on the tape outputs.

This makes it possible to listen to a source (e.g. AUX) monophonically while simultaneously recording a stereophonic broadcast on tape.

ADDITIONAL TECHNICAL DATA

Total harmonic distortion (1 kHz):	less than 0.02% at 2 V output voltage
Frequency response:	+ 0 dB/-0.7 dB, 20 Hz ... 20 kHz
Semi-conductor complement:	100 transistors, 77 diodes, 19 variable capacity double diodes, 45 ICs, 1 micro processor 4K x 8 bit, 3 bridge rectifiers, 9 7-segment displays
Weight (mass):	28 lbs 10 ozs (13 kg)
Dimensions (W x H x D):	17.8 x 6 x 13.8 inches (452 x 151 x 350 mm)

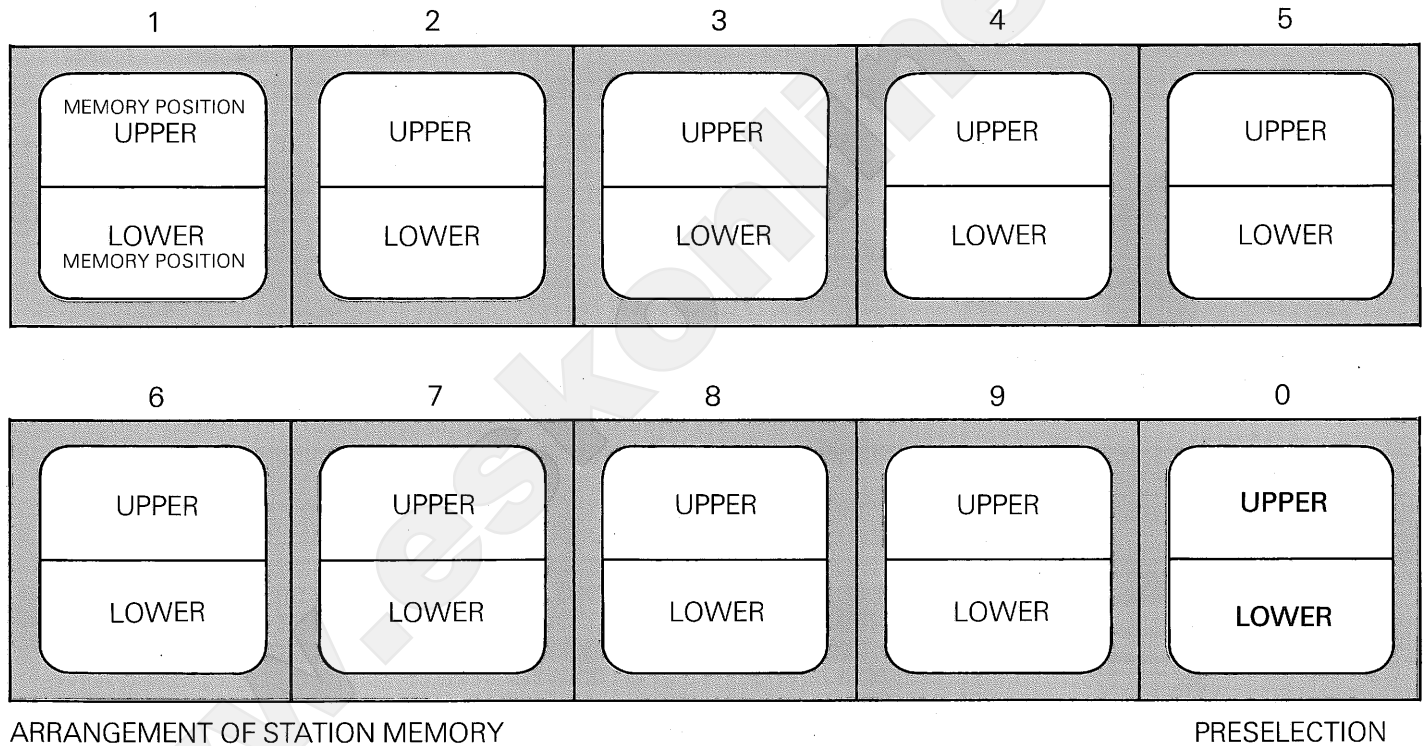

WARRANTY

For equipment purchased in Belgium, The Federal Republic of Germany, Austria and France a special warranty application card is either contained in a plastic envelope attached to the outside of the packing carton or it is enclosed with the equipment. If this card is MISSING, please request it from your dealer or write directly to your national REVOX distributor.

Complete the warranty application and return it to your national distributor who will then send you your warranty card.

For equipment purchased in Switzerland, the warranty responsibility rests with the dealer. Please note that the warranty is not valid outside the country of purchase.

The warranty will be invalidated if the unit is tampered with or serviced by unauthorized personnel.

FM ANTENNAS

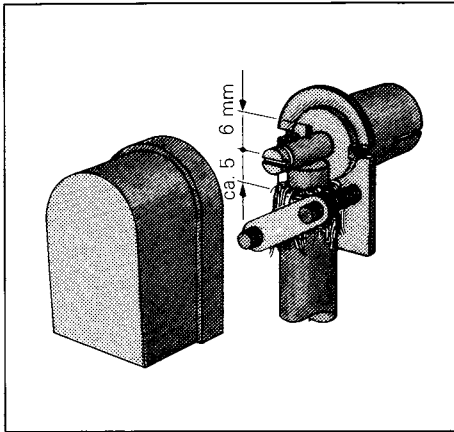

To take full advantage of the high standard of quality as provided by the B780 Receiver, it is important to operate it on an antenna system which delivers sufficiently high signal levels.

The ideal set-up is represented by a rotatable outdoor antenna with high directional gain. With the optional antenna rotator control, a preferred antenna direction may be programmed for each station that is entered into the memory. In many more densely populated areas, FM signals of sufficient quality are provided by community antenna systems.

In cases where there is no possibility to operate the B780 with an outdoor antenna and where community antenna systems do not exist, a good indoor antenna will be the only alternative. An indoor antenna, however, can at best be an expedient only, because its small dimensions will provide only small signal levels and additional losses result from the shielding effect inside buildings of modern re-enforced concrete construction. Furthermore, the interference levels within a building are much higher as compared with those on the outside. But even so, good reception with a suitably placed indoor antenna is possible up to a distance of several miles from the transmitter.

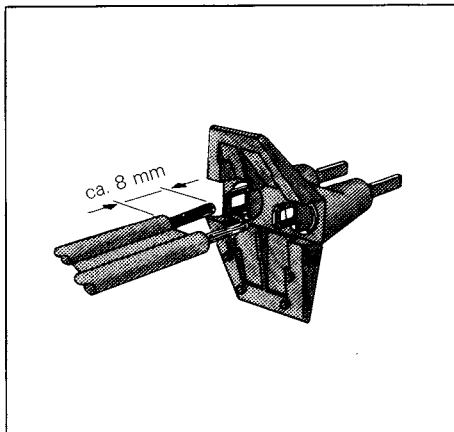

For signals in the FM band, having a wavelength of 3 m approximately, wave propagation is similar to that of light. Therefore, the best reception will result if the antenna can be placed within line of sight of the transmitter. Suitable antenna constructions will permit reasonable quality reception even beyond the optical horizon.

Very short radio waves will be reflected by obstructions whose dimensions exceed the wave-length of the radiated signal. If such a reflected signal is picked up by the antenna together with the directly received signal, annoying delay distortions will be generated in the receiver (multipath reception, ghost pictures in the case of television). Delay distortions can be eliminated by optimal orientation of a high quality directional antenna.

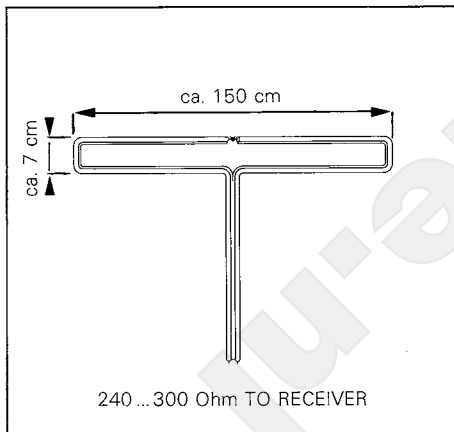

If an outdoor antenna is not available or when wanting to experiment, a simple antenna can be constructed with little effort from 300 Ohm twin lead cable. It must be pointed out, however, that such make-shift constructions are the last resort and they should be used only if a proper antenna system cannot be utilized. These do-it-yourself constructions will yield acceptable results only when trying to receive nearby stations that produce an electric field of considerable strength. Such an antenna must be installed in a transvers plane to the direction of reception.

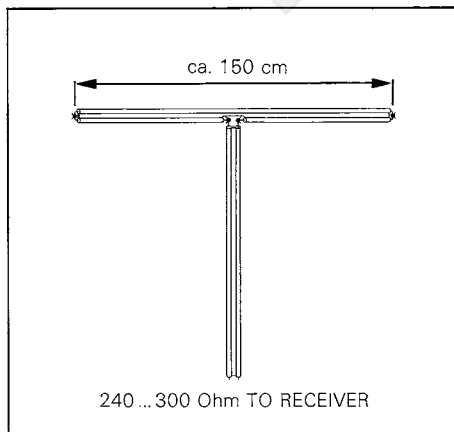

DELAY DISTORTION RESULTING FROM MULTIPATH RECEPTION

MEASURING THE DELAY DISTORTION WITH THE HELP OF AN OSCILLOSCOPE

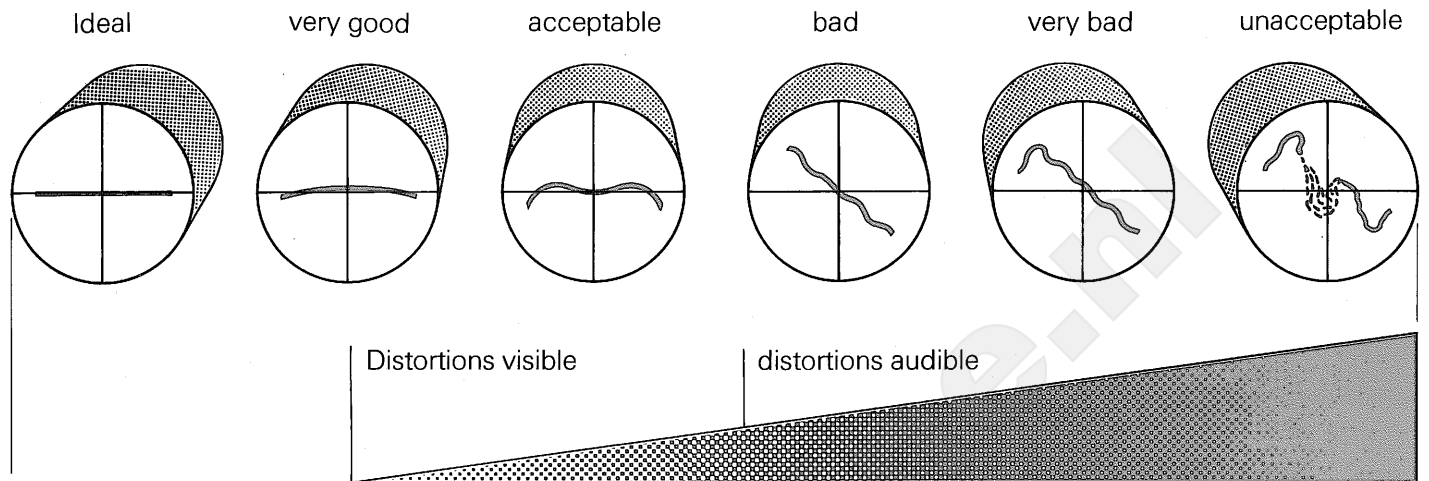

MEASURING FREQUENCY DEVIATION AND SIGNAL STRENGTH

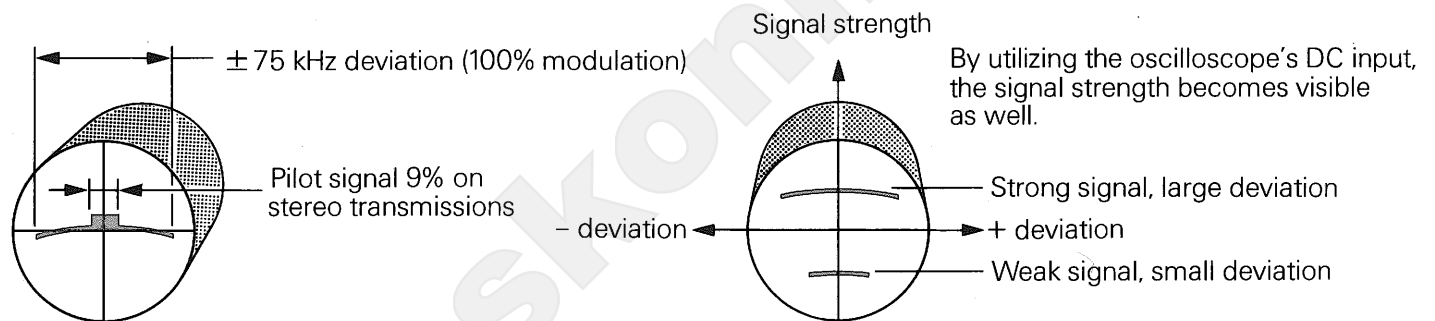

TEST SET-UP TO DETECT MULTIPATH RECEPTION

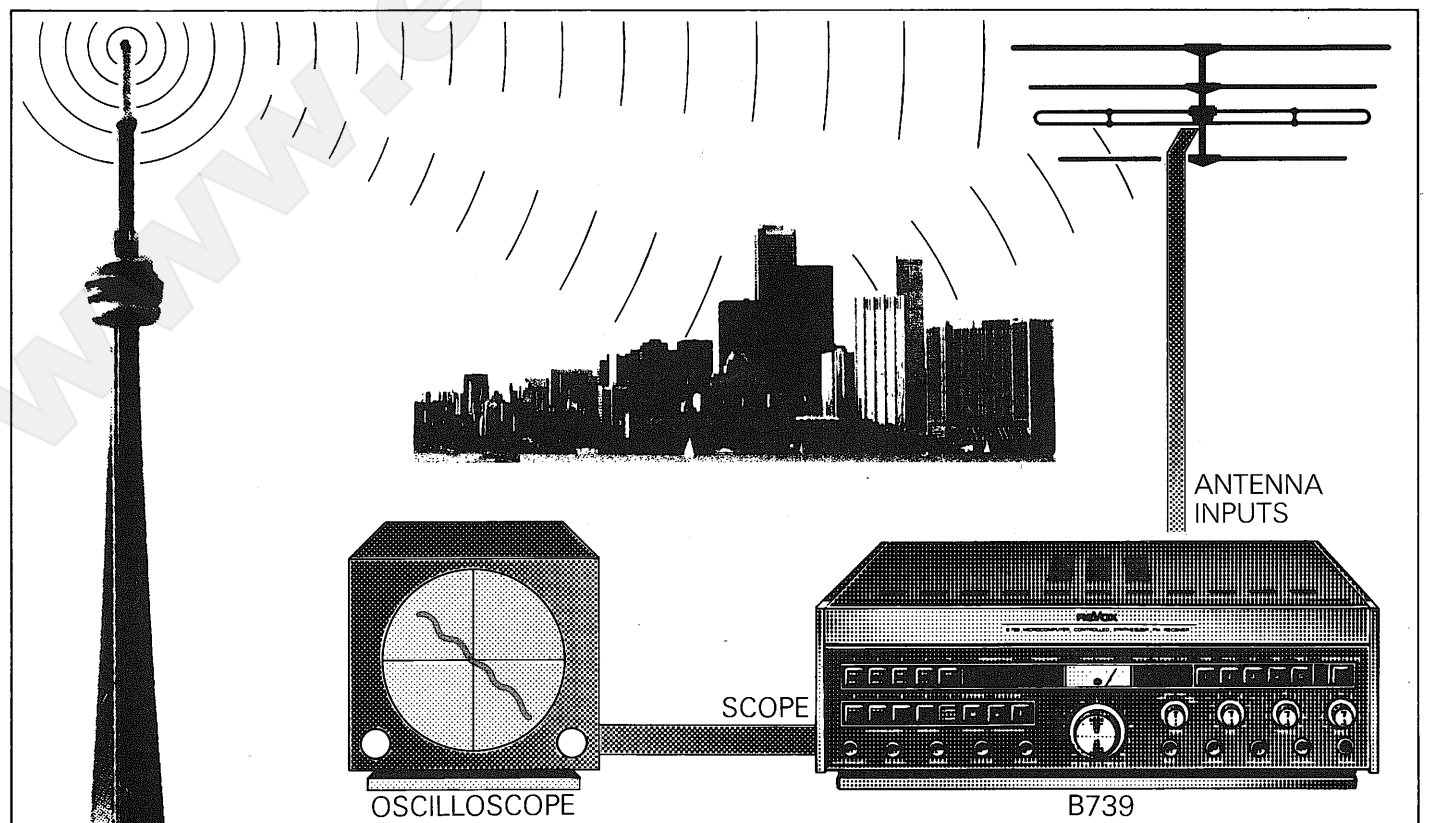

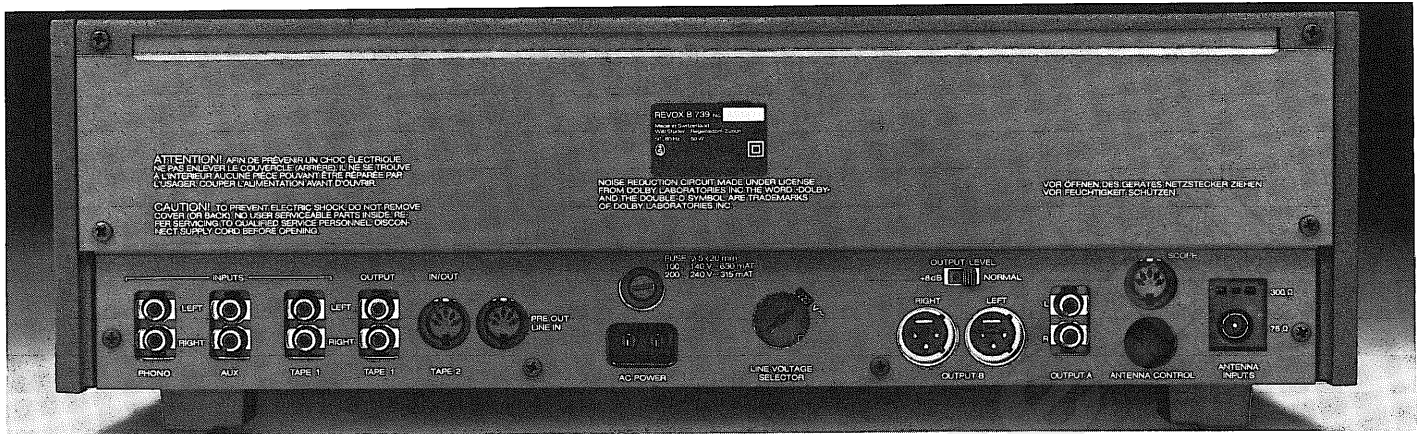

WIRING OF CONNECTORS

JACK PREAMP OUT.
0.85 Volts/RLmin. 47 kOhms

JACK PHONES
11.8 Volts/shortcircuit proof, optimal phone impedance 200 ... 600 Ohms



XLR socket OUTPUT B
2 V/220 ohms

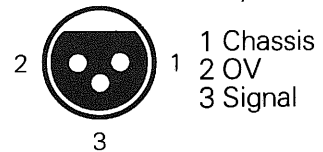

DIN socket TAPE 2 IN/OUT

IN: 150 mV/50 kOhms
OUT: 5.5 mV/RL min. 10 kOhms

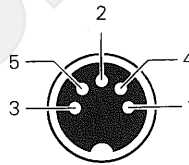

1 Output left
2 Chassis, screen
3 Input left
4 Output right
5 Input right

DIN socket PRE OUT/LINE IN

OUT: 0,85 V/RL min. 10 kOhms
IN: 1 V/50 kOhms

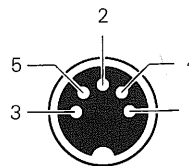

1 PRE left
2 Chassis, screen
3 LINE left
4 PRE right
5 LINE right

DIN socket SCOPE

Output to scope:
Vertical (Y): 1 Volt RF for 50 mV on 75 Ohms
Horizontal (X): 2.8 V_{pp} at 75 kHz deviation

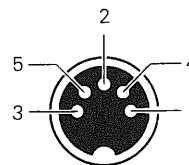

1 X deflection
2 Chassis
3 Y deflection
4 Remote switching optional
5 Remote switching

INTERCONNECTING CABLES

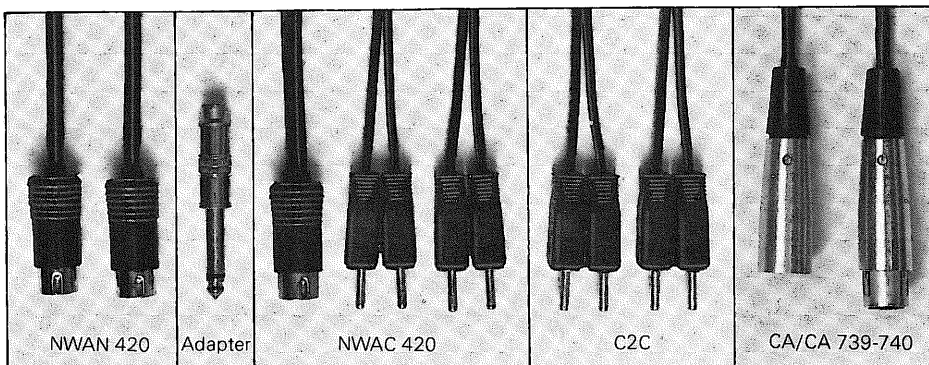

- NWAN 420 6 ft. 6 inch. (2 m) 5-pin DIN connector at both ends, Stereo record/reproduce. Art. no. 33092.
- Adapter phono socket/jack plug. Art. no. 33405.
- NWAC 420 6 ft. 6 inch. (2 m) 2x double phono plug to DIN plug. Stereo record/reproduce. Art. no. 33082.
- C2C 210 3 ft. 3 inch. double phono plug at both ends. Two channel interconnection. Art. no. 33041.
- C2C 220 6 ft. 6 inch. (2 m) double cinch plug at both ends. Two channel interconnection. Art. no. 33042.
- CA/CA 739-740 3 ft. 3 inch. (1 m) Cannon (XLR) plugs at both ends. One channel interconnection. Art. no. 33211

B739 FUNCTION DIAGRAM

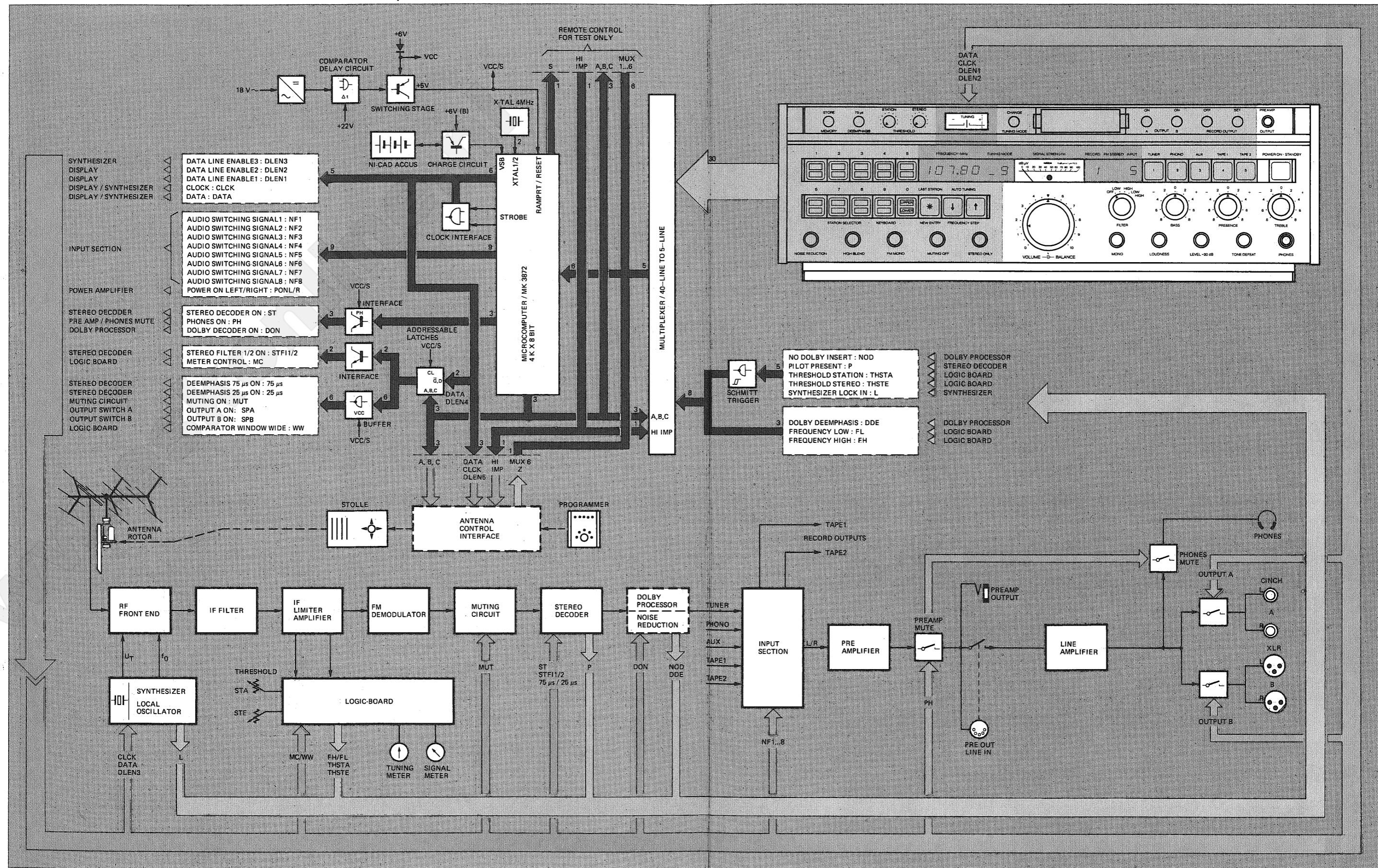

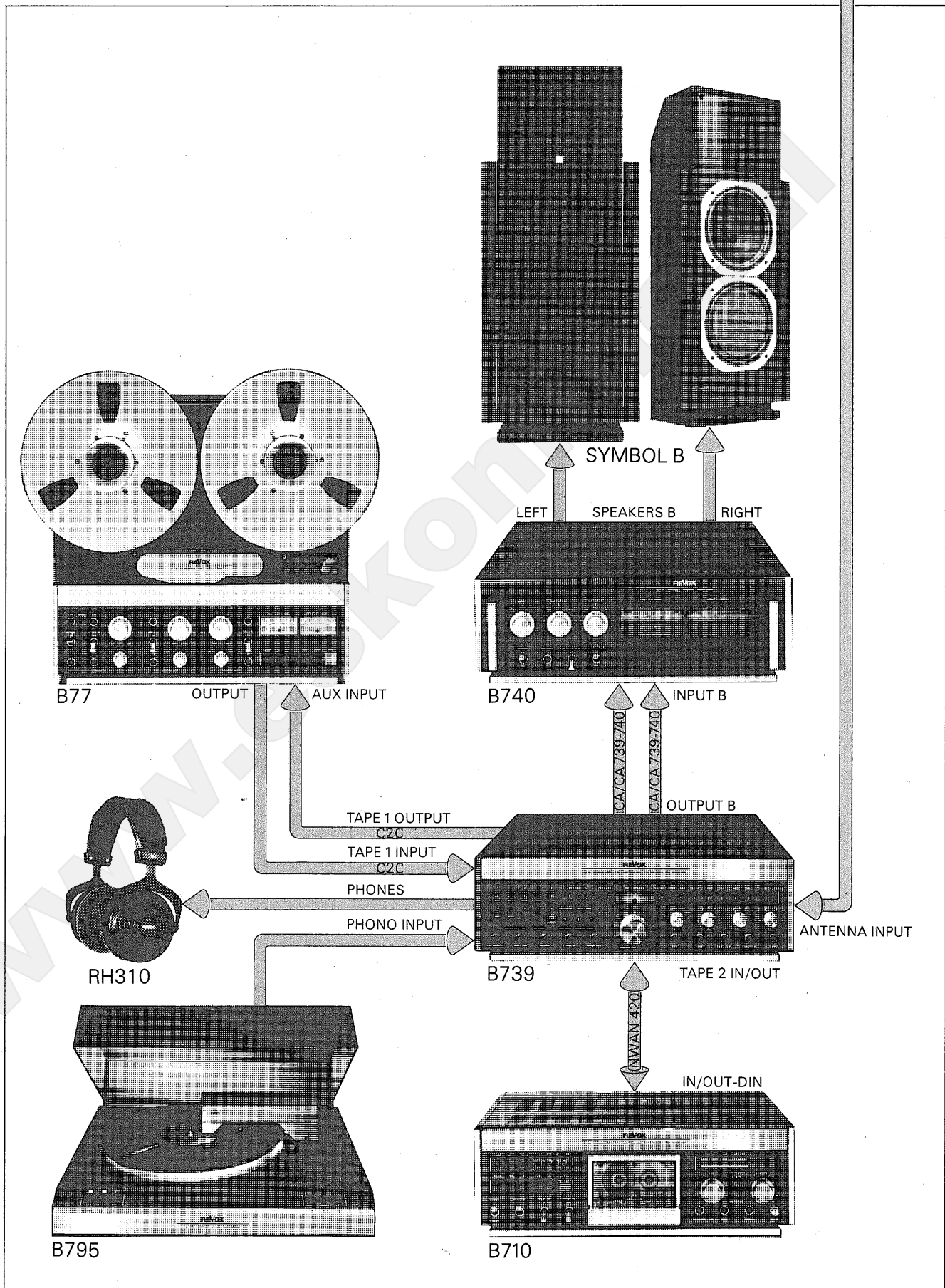

B77

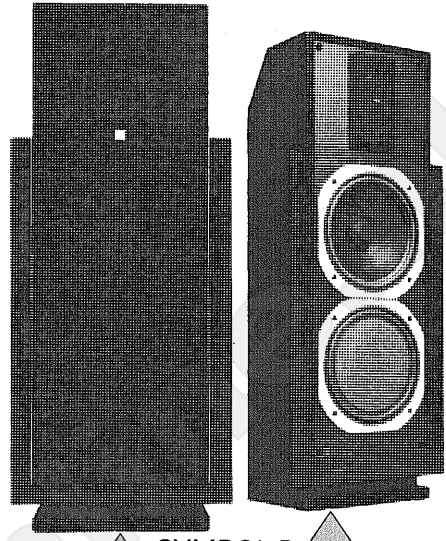

SYMBOL B
LEFT SPEAKERS B RIGHT

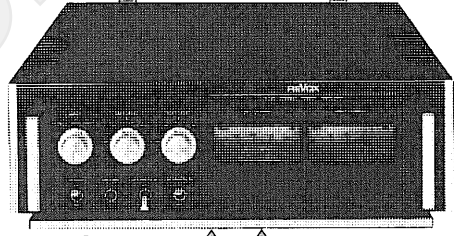

B740

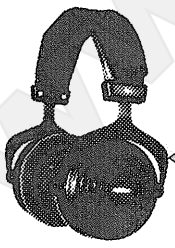

RH310

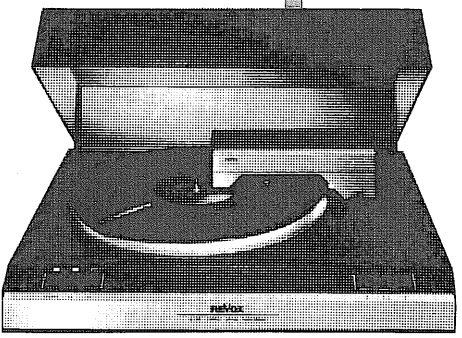

B795

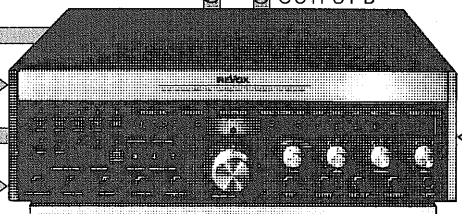

B739

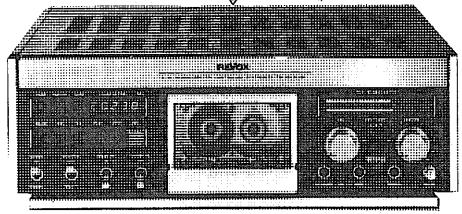

B710

Manufacturer

WILLI STUDER AG
CH-8105 Regensdorf/Switzerland
Althardstrasse 30

STUDER REVOX GmbH
D-7827 Löffingen/Germany
Talstrasse 7

Worldwide Distribution

REVOX ELA AG
CH-8105 Regensdorf/Switzerland
Althardstrasse 146

