

STUDER REVOX

# C270

## Operating Instructions



- Vorsicht:** Das Gerät ist in ausgeschaltetem Zustand (STANDBY) nicht von der Stromzuführung getrennt.
- Attention:** Cet appareil n'est pas séparé du réseau lorsqu'il est déclenché (STANDBY).
- Warning:** This unit is not separated from the mains supply when switched off (STANDBY).
- Attenzione:** Questo apparecchio non è separato dalla rete quando l'interruttore è spento (STANDBY).
- Precaución:** Este aparato no está separado de la red cuando está apagado (STANDBY).
- Waarschuwing:** In uitgeschakelde toestand (STANDBY) is het apparaat niet gescheiden van de netspanning.
- Advarsel:** Apparaten er ogsaa hvis lukket (STANDBY) under strøm.
- Huomio:** Huolimatta siitä, että virta on katkaistu laitteesta (STANDBY), sitä ei ole eristetty sähköstä.
- Forsiktig:** Selvom strømmen ikke er pa i apparatet (STANDBY), sa er det ikke skilt fra strøm.
- Varning:** Oaktat om strömmen är avbruten i apparaten (STANDBY), sa är den ända kopplad med strøm.

# Operating Instructions

## REVOX C270 · Tape Recorder

---

For the sake of clarity and ease of use, these operating instructions have been subdivided into the following five Sections:

### **SECTION 1**

#### **Installation and first time operation**

Contains all information required for correct installation and connection of the tape recorder.

### **SECTION 2**

#### **Operation**

Provides basic information concerning the operation of the tape recorder such as PLAY and RECORD mode.

### **SECTION 3**

#### **Extended Operation**

Explains all auxiliary and special functions that are not described in Section 2 such as LOCATOR, waste basket mode, and editing.

### **SECTION 4**

#### **Technical appendix**

Contains interesting information on the design of reel-to-reel tape recorders, hints on level standards, as well as for converting the unit. The technical data and dimensions are also included in this Section.

### **SECTION 5**

#### **List of keypad functions**

Contains quick-reference instructions for the experienced user and provides a quick overview of all keypad functions.

#### **Indexed synoptical drawing**

At the end of this manual you will find a foldout page with a synoptical drawing on which index numbers have been provided. The index numbers which in the text appear between brackets correspond to those on the drawing.

---

Protect your tape recorder from exposure to excessive heat and moisture. Install it in a position where the ventilation louvers are not obstructed.

## WARRANTY

A special warranty request card is included with all equipment sold within the Federal Republic of Germany. This card is located either inside the packing or in a plastic pouch attached to the outside of the packing. Should this card be missing, please consult your REVOX dealer or your national REVOX distributor.

Warranty cards for equipment sold in Switzerland or Austria are issued directly by the authorized dealer.

Please note that the warranty is only valid within the country in which the equipment has been sold. The warranty becomes null and void if unauthorized modifications or unprofessional repairs are made.

## PACKING MATERIAL

Please retain the original box for reuse in case your equipment ever needs to be transported. The packing material has been especially designed to protect your valuable equipment from mechanical shock in transit.

Subject to change.  
Printed in Switzerland by WILLI STUDER AG  
Order number 10.30.0780 (Ed. 0688)  
Copyright by WILLI STUDER AG  
CH-8105 Regensdorf-Zurich

REVOX is a registered trade mark of  
WILLI STUDER AG Regensdorf.

## Contents

---

### SECTION 1

#### Installation and first operation

	Page
Items included with the recorder _____	4
Setup _____	4
Line Voltage _____	5
Connecting the signal sources _____	5
Switching on the tape recorder _____	6

### SECTION 2

#### Operation

Inserting the tape _____	7
Tape speed (SLOW/FAST) _____	8
Tape transport functions _____	9
PLAY mode _____	10
RECORD mode _____	11
Monitor speaker _____	13

### SECTION 3

#### Extended operation

Variable tape speed _____	15
Locator function _____	16
LOOP mode _____	19
Waste basket mode (T-DUMP) _____	20
Editing function (EDIT) _____	21
Tape scissors _____	22
Reproduce delay _____	24
Automatic recording _____	25

### SECTION 4

#### Technical appendix

Track configuration on the tape _____	27
Care and maintenance instructions _____	29
Equalizations (IEC, NAB) _____	30
Alternate tape speeds _____	31
Calibration (standard level) _____	33
Technical data _____	35
Dimensions _____	36

### SECTION 5

#### Quick-reference descriptions

Index of keypad functions _____	37
Correct insertion of the tape _____	43
Indexed synoptical diagram _____	44
Audio block diagram _____	45

# SECTION 1

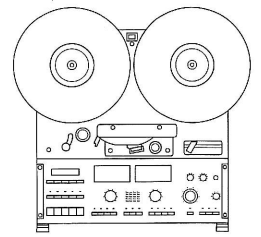

## Installation

Items included with the recorder,  
Setup

### Items included with the recorder



In addition to these operating instructions and the tape recorder, the packing also contains a power cord fitted with a plug that conforms to the standards of your country, as well as 3 plugs and a set of 7 fuses for MONITOR, FADER START, RS232, plus a set of diagrams. Please consult your dealer if any of the above items is missing or incorrect. These operating instructions are also available in the following languages:

DEUTSCH: Bestellnummer: 10.30.0780  
FRANÇAIS: No. comm.: 10.30.0790

### Setup

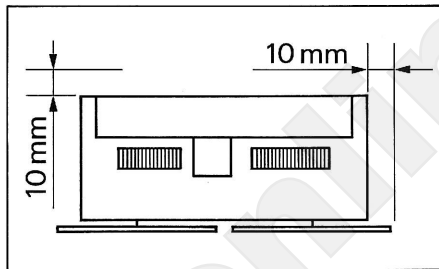

Install your recorder in a position where the ventilation louvers are not obstructed. A ventilation clearance of at least 10 mm ( $\frac{1}{2}$ " ) should be maintained to other equipment, walls and furnishings.

### Important safety instructions

Connect the recorder to an AC outlet using the included power cable.

Always keep the equipment in dry condition. It is extremely hazardous to operate it in wet rooms (bathroom, laundry room, basement, etc.).

The recorder is designed to be operated in any position between horizontal and vertical. In case of a malfunction or a defect, immediately disconnect the power plug and have the tape recorder inspected by an authorized REVOX dealer.

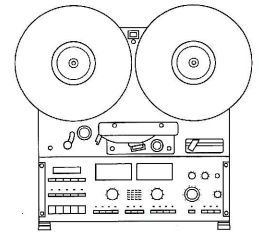

**Checking the line voltage**

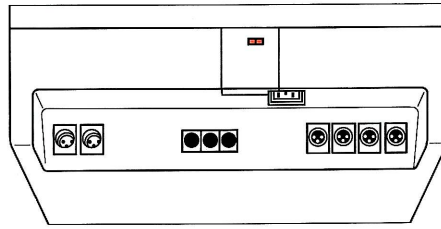

Make sure that the voltage rating visible through the window agrees with the local AC supply voltage. If necessary, the unit can be converted to a different line voltage but this work should be performed by your dealer.

**Connecting the signal sources**

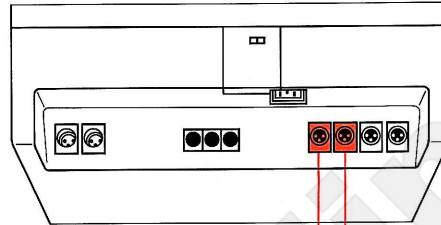

The LINE INPUT CH1 and LINE INPUT CH2 should be connected to the OUTPUT connectors of a signal source (mixing console). For this purpose you can use commercially available, balanced connecting cables or you can prepare the cables yourself. Make sure that the conductors are wired correctly.

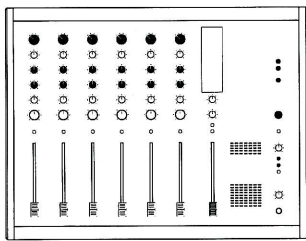

C279

**Connecting the outputs**

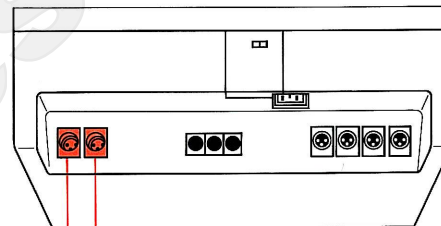

The LINE OUTPUT CH1 and LINE OUTPUT CH2 should be connected to the INPUT connectors of your amplifier or to the inputs of a mixing console. For this purpose you can use commercially available, balanced connecting cables or you can prepare the cables yourself. Make sure that the conductors are wired correctly.

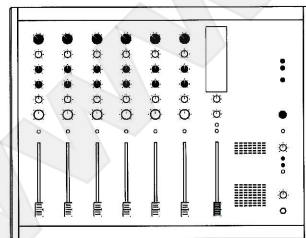

C279

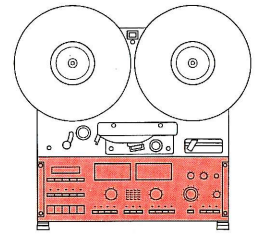

Switching on the tape recorder

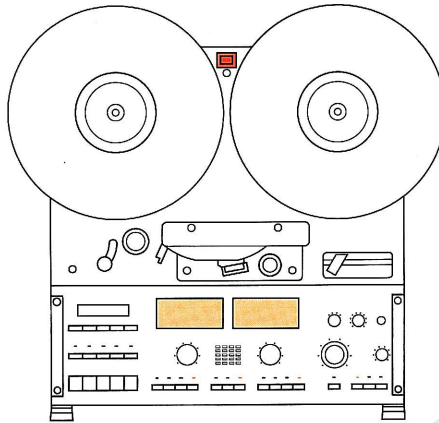

When you press the POWER [1] key on the front panel, the tape recorder switches on. Press the same key again and it switches off. When you switch on the tape recorder, the VU-meters are illuminated and the last active system parameters (tape speed, tape address) are shown on the real-time tape counter [7], and the output selectors (INPUT, SYNC, READY) are restored to their previous position. The last active settings are stored again when the unit is switched off. The tape recorder cannot be switched on or off by means of the remote control.

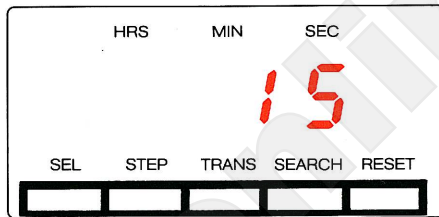

After the tape recorder has been switched on, the Real Time counter [7] displays the chosen tape speed "ips" for approx. 2 seconds. Subsequently, the actual tape position is shown.



## SECTION 2

### Operation

### Inserting the tape

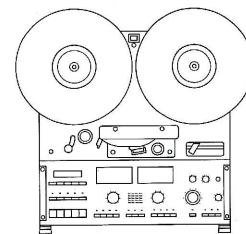

#### Three-pronged reel (DIN)

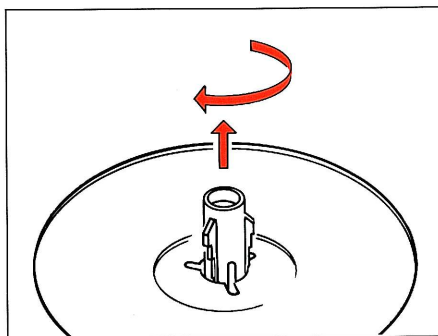

Mount the full reel on the left-hand spindle [2] and the empty reel on the right-hand spindle [3]. To lock the reel, pull out the three-pronged guide and rotate it by 60°.

#### NAB reel

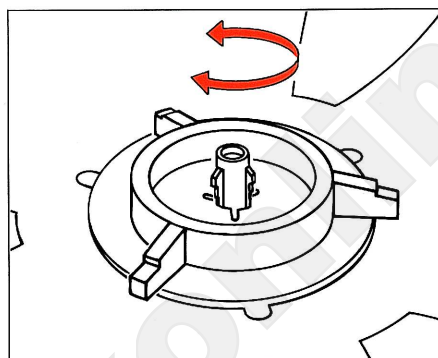

Mount the NAB adapters on the spindles [2/3]. To lock the adapter, pull out the three-pronged guide and rotate it by 60°. Mount the full NAB tape reel on the left-hand NAB adapter and the empty NAB reel on the right-hand NAB adapter. To secure the reels, turn the upper part of the adapter clockwise until it engages.

#### AEG platter (for self-supporting pancakes)

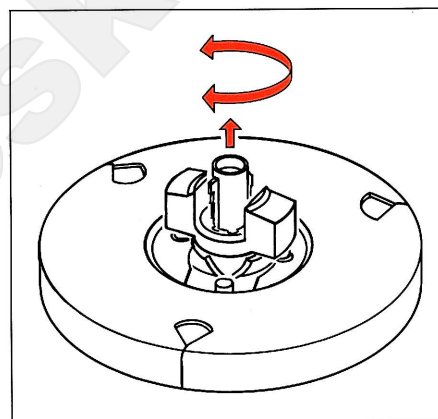

Mount the adapter platters on the spindles [2/3]. To lock the adapter, pull out the three-pronged guide and rotate it by 60°. Mount the tape pancake on the left-hand platter and an empty hub on the right-hand platter. To secure the hubs, lift the adapter clip and rotate it by 90° so that they rest on the two guide pins.

#### Threading the tape

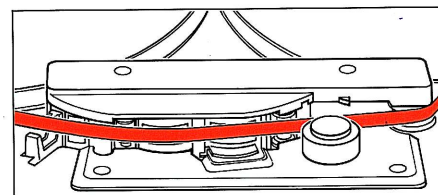

Thread the tape as shown in the opposite diagram. It must be smoothly guided around the tape tension sensor [6], the tacho roller [4], and the right-hand guide pin. Thread the beginning of the tape around the right-hand reel and secure the tape by giving the reel a few counterclockwise turns.

If the tape starts with a transparent leader, spool the tape forward by pressing the >>> key [19] so that the oxide coating covers the light barrier [5]. Then press the RESET [8] key to set the tape counter [7] to zero. If the tape counter is always set to zero at the same tape position, the tape can be positioned at any address with split-second accuracy by means of the real-time counter [7].

A detailed description of the correct way to thread the tape is given on page 43 of these operating instructions.

# Operation

## Tape speed (SLOW/FAST)

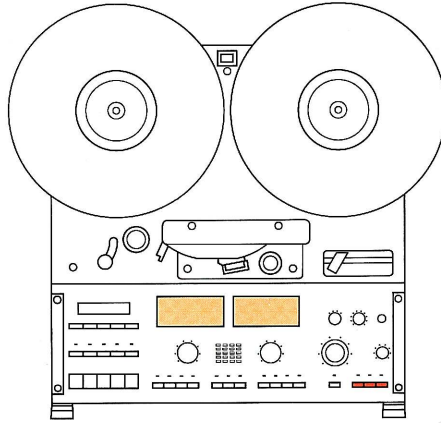
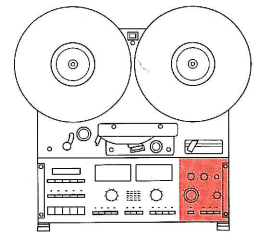

The REVOX C270 tape recorder can be operated with any two of three speeds. Depending on the configuration of your unit, one of the following speed pairs is available:

Position: SLOW	Position: FAST
9.5 cm/s	19 cm/s
19 cm/s	38 cm/s
9.5 cm/s	38 cm/s

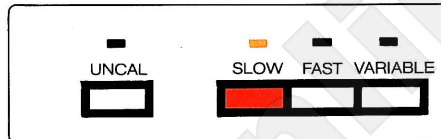

With the SLOW [40] key, the slower speed is selected, with the FAST [41] key the higher speed is selected. The corresponding LED above the key lights up. The selected tape speed is always displayed on the real-time counter [7] for a few seconds. The speeds are not indicated in cm/s but in ips (inches per second):

3.75 ips	=	9.5 cm/s
7.5 ips	=	19 cm/s
15 ips	=	38 cm/s

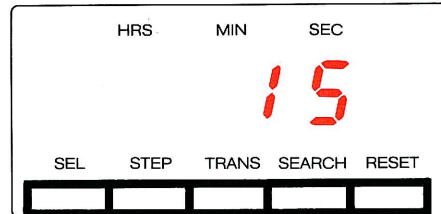
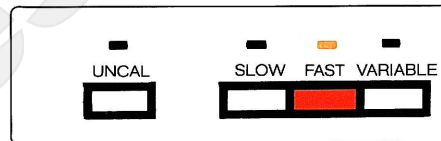
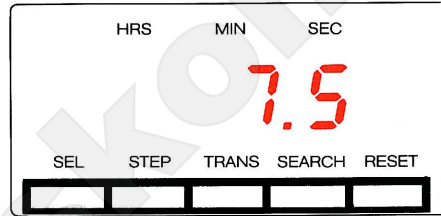

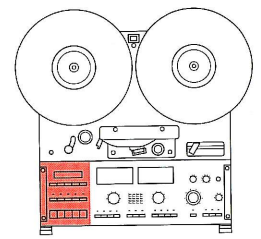

## Operation

### Tape transport functions

#### << [18] Fast rewind

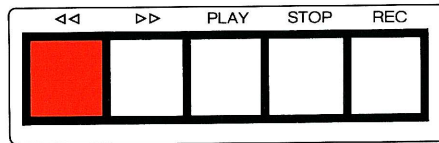

When you press the << key, the tape is spooled at high speed from the right-hand to the left-hand reel. In order to protect the tape and the soundheads, the tape is mechanically lifted off the soundheads. The tape cannot be played in this mode.

#### >> [19] Fast forward

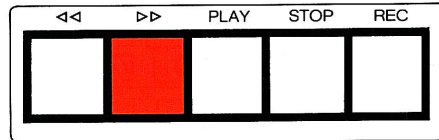

When you press the >> key, the tape is spooled at high speed from the left-hand to the right-hand reel. In order to protect the tape and the soundheads, the tape is mechanically lifted off the soundheads. The tape cannot be played back in this mode.

#### PLAY [20]

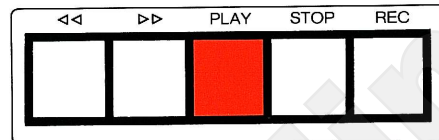

The play [20] key activates the reproduce mode. The recording on the tape can be heard.

#### STOP [21]

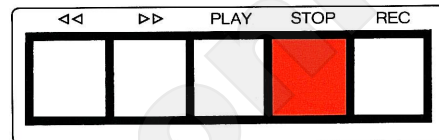

The STOP [21] key cancels the current operating mode.

#### REC [22]

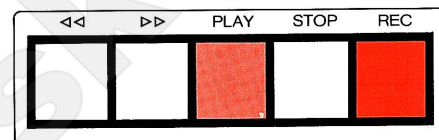

The REC [22] key is pressed together with the PLAY [20] key in order to activate the record mode. Recording is now possible on channels that have been activated with the READY [24/33] keys.

#### Note:

Any of the foregoing keys can be pressed in any operating state of the recorder. The built-in microprocessor automatically checks the validity of the command and protects the tape by first decelerating it before a different sense of rotation or speed is activated.

# Operation

## PLAY mode

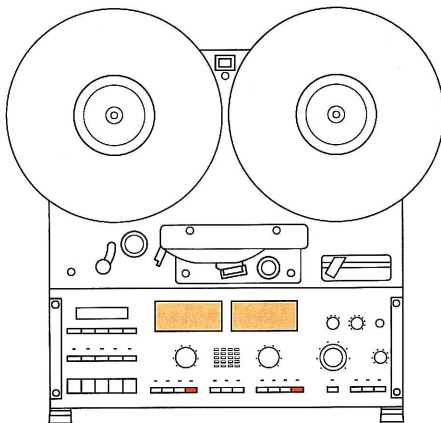
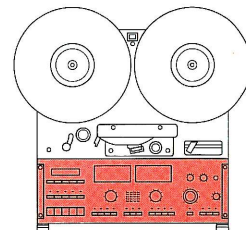

The following steps are necessary for reproducing the recording on a tape:

- Insert the tape.
- Set the output selector of both channels to REPRO [27/36].

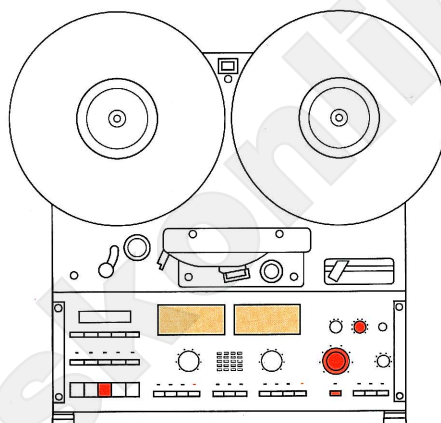

- Press the PLAY [20] key. The play mode is activated and the recording can be heard via a connected amplifier or the built-in monitor speaker (pull VOLUME [46] knob). The level available at LINE OUTPUT CH1 and LINE OUTPUT CH2 can be varied with the OUTPUT [38] level potentiometer, provided uncalibrated output level has been selected with the UNCAL [39] key. Each channel can be adjusted individually by turning the two concentric knobs. The inner knob influences the level of channel 1, the outer knob influences channel 2.

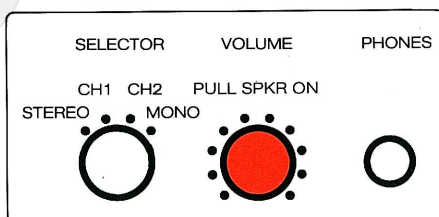

The monitor speaker volume can also be adjusted with the VOLUME [46] potentiometer.

# Operation

## Record mode

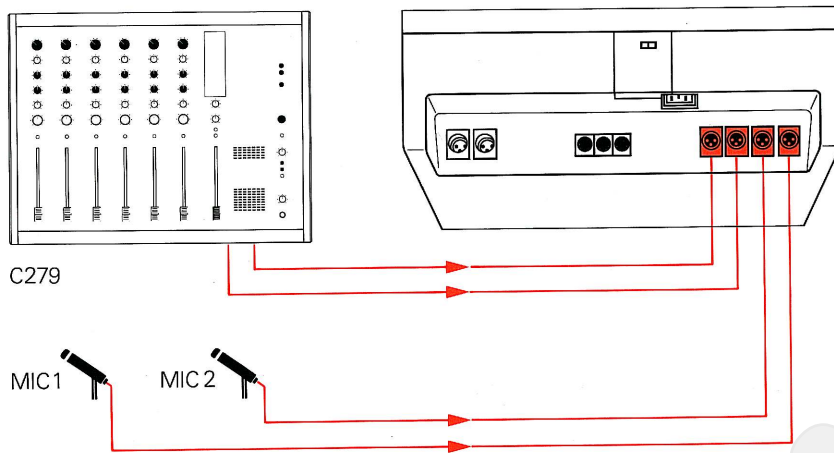
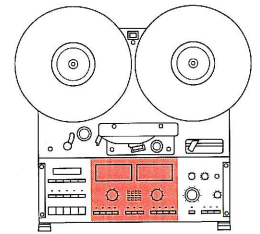

For making a recording, the LINE INPUT CH 1 and LINE INPUT CH 2 must be connected to a signal source (amplifier, tape recorder, mixing console) or, on models with built-in microphone amplifier (Option: MIC/LINE SWITCH BOARD 1.777.520.00), the microphones should be connected to the MIC INPUT CH 1 and MIC INPUT CH 2.

- Mount the tape.

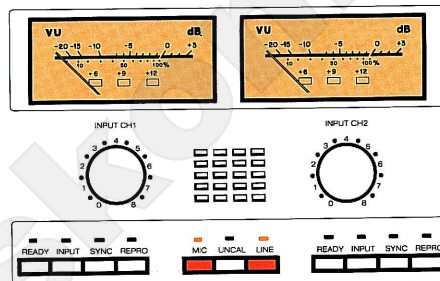

- Set the input selector to LINE [31], or to MIC [29] if the recording is made via the microphones.

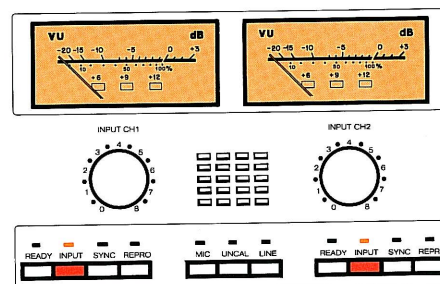

- Set the output selectors of both channels, or of the channel to be used for recording, to INPUT [25/34].

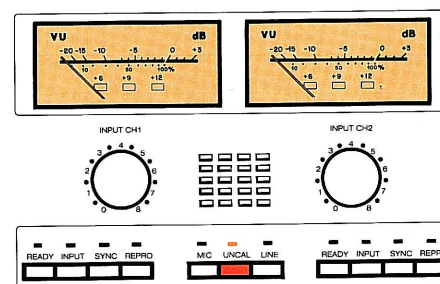

- The VU-meters [23/32] indicate the level of the input signal. If the level is too low or too high, press the UNCAL [30] to switch to uncalibrated operation (always automatically activated in MIC mode), and adjust the input level by means of the level potentiometers INPUT CH 1 [28] and INPUT CH 2 [37].

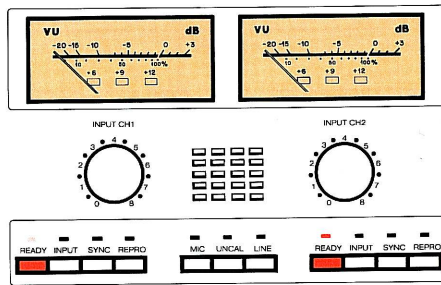

● Enable the channels for recording by pressing the READY [24/33]. The red LED flashes. A channel that is not to be overwritten on the tape should not be switched to READY.

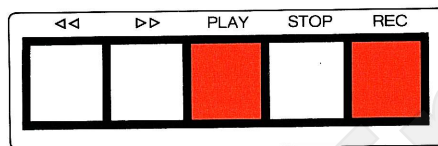

● Start the recording operation by simultaneously pressing the REC [22] and PLAY [20] keys. The red LED above the READY keys is continuously light.

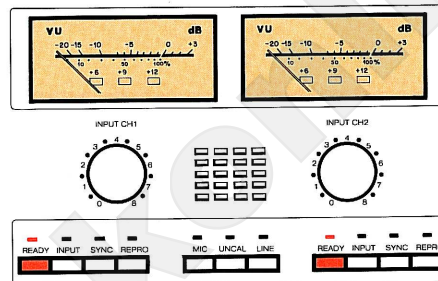

# Operation

## Monitor speaker

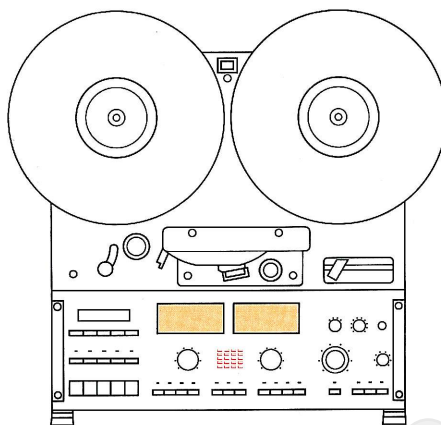
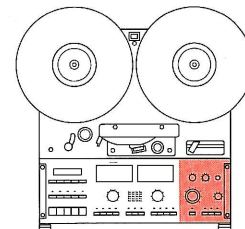

With the aid of the built-in monitor speaker it is possible to listen to previously made recordings without any amplifier, or to monitor the recordings while they are being made.

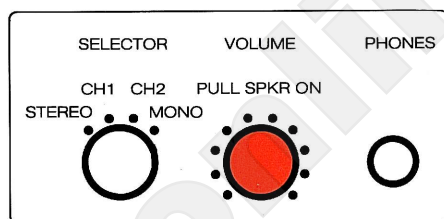

● The monitor speaker is activated by pulling up the VOLUME [46] knob, and its volume can be adjusted by turning the knob. To switch off the speaker simply push in the button.

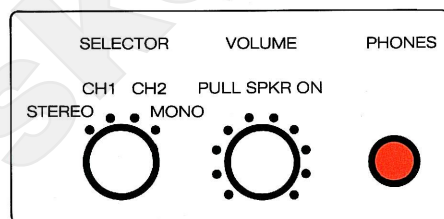

● The monitor speaker is automatically switched off when the headphones are plugged into the connector [45].

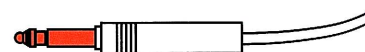

6,3 mm

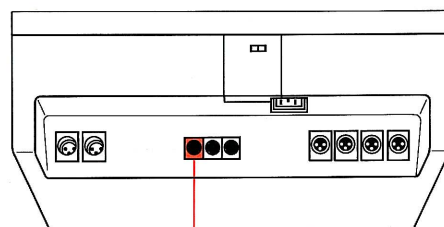

● An additional monitor amplifier with speakers can be connected to the MONITOR socket. This amplifier is not switched off when headphones are plugged in.

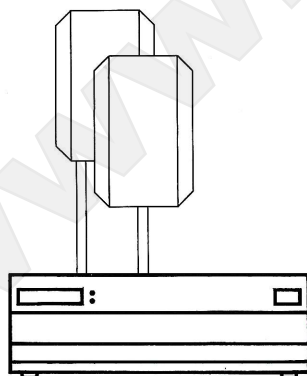

B242

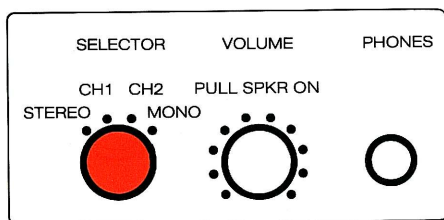

● The reproduction mode can be defined with the SELECTOR [44] switch. In the STEREO position, both channels (monophonic) can be heard over the built-in monitor speaker. The stereophonic signal can be heard via the headphones socket or the MONITOR socket.

In the position CH1 or CH2, only channel 1 or 2 is reproduced. On the headphones and the MONITOR socket, the selected channel can be heard on the left-hand or right-hand channel respectively.

In the MONO position both channels are added and reproduced as monophonic signal.

**Note:**

The SELECTOR [44] switch influences only the reproduction via the MONITOR speaker or the PHONES [45] socket. It has no effect on the LINE OUTPUT CH1 and LINE OUTPUT CH2.



# SECTION 3

## Extended operation

### Variable tape speed

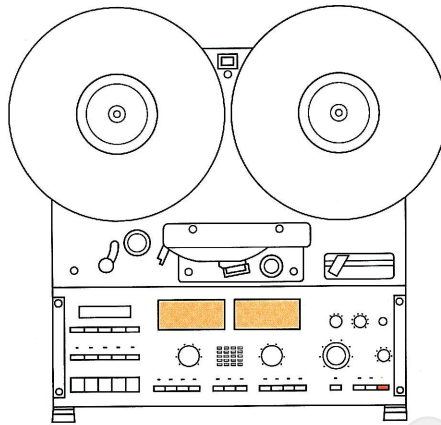
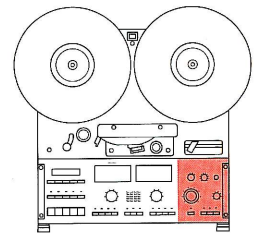

In reproduce as well as record mode, the tape speed can be varied by pressing the VARIABLE [42] key; the yellow LED above this key lights up.

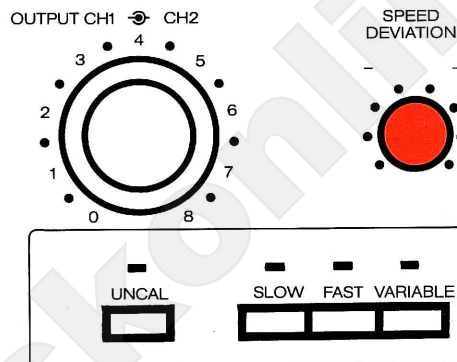

The deviation of the tape speed from the selected nominal speed (SLOW/FAST) can be varied within the range of -33% to +50%.

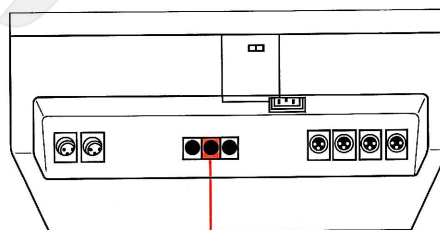

The tape speed can also be varied externally via the FADER/SYNC socket by means of a TTL signal (0V/+5V) within the range of -33% to +50%. The nominal speed is achieved with a control frequency of 9.6 kHz. Pin 1 of the connector is to be connected to GND (0V) and the TTL signal to pin 4.

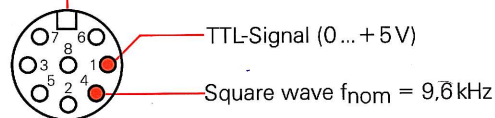

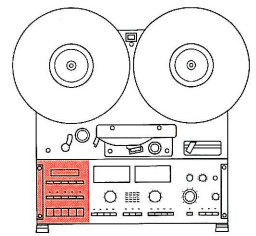

## Extended operation

### Locator function

#### Z-LOC [13]

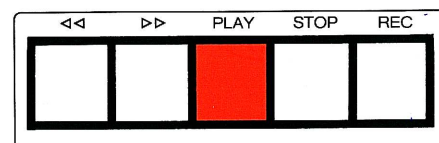
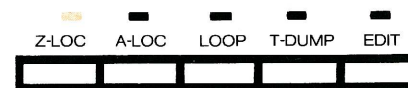
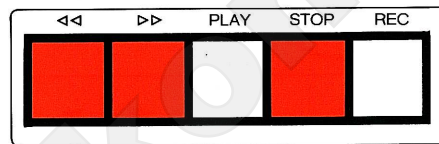
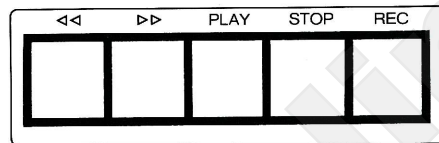
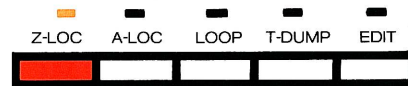
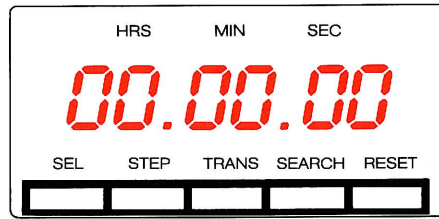

When you press the Z-LOC [13] key, the tape positions at the counter address 00.00.00; the yellow LED above the key lights up. The Z-LOC function can be activated in any mode except in record and T-DUMP mode.

When you press the STOP [21] key or one of the spooling keys << [18] or >> [19], the search is cancelled and the selected function is executed.

While the tape is being positioned, you can preselect play mode by pressing the PLAY [20] key. This is acknowledged by the flashing LED above the Z-LOC [13] key. As soon as the tape address 00.00.00 is reached, the recorder switches automatically to play mode.

## Extended operation

## Locator function

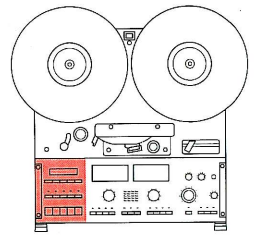

### A-LOC [14]

The A-LOC [14] key puts a user-programmable address locator at your disposal. When you press this key, the tape is positioned at the counter address stored in the address locator.

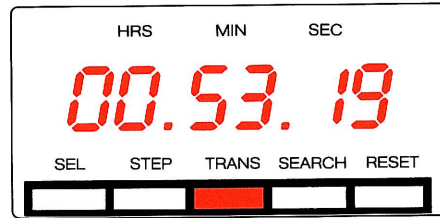

By pressing the TRANS [10] key, you can transfer the momentary address of the real-time counter into the A-LOC for use in subsequent search functions.

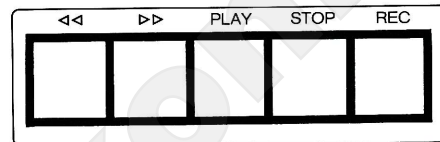
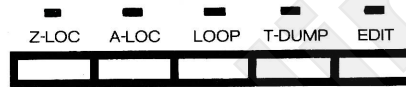

Proceed as follows for searching a specific tape location or to transfer it into the A-LOC:

- Press the SEL [8] key: the address stored in the A-LOC is displayed, the first digit of the display flashes.

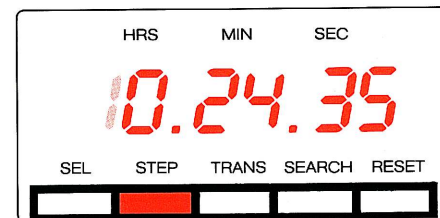

- The displayed value can be modified by pressing the STEP [9] key repetitively. Continue pressing this key until the desired address is displayed.

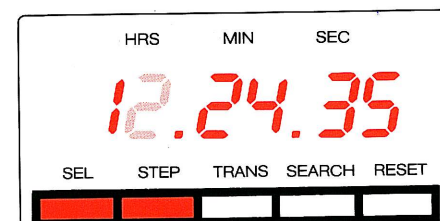

- Press the SEL [8] key again: the second digit of the display flashes and can be modified with the STEP [9] key. The complete tape address can be entered by repetitive pressing of the SEL [8] key and the STEP [9].

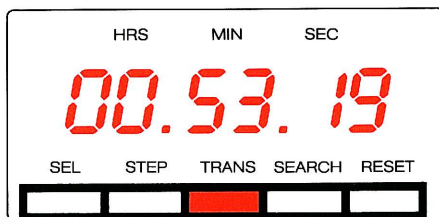

● The content of the A-LOC display can be transferred into the memory by pressing the TRANS [10] key. The display then changes back to indicating the current tape location.

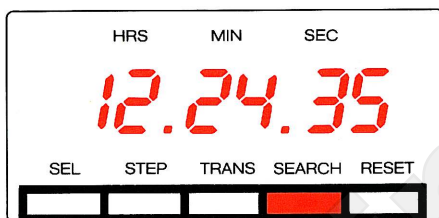

● When you press the A-LOC [14] key, the tape is automatically positioned at the programmed address.

Instead of pressing the TRANS [10] key you can also press the SEARCH [11] key. In this case the content of the display is not transferred into the A-LOC, however, the tape will be positioned at the specified address.

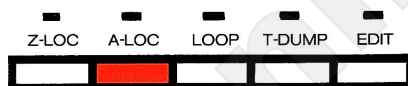

The positioning operation is cancelled when the STOP [21] key or one of the spooling keys << [18] or >> [19] is pressed, and the selected function is immediately executed.

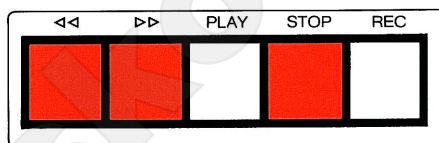

While the tape is being positioned, you can preselect the play mode by pressing the PLAY [20] key. This is acknowledged by the flashing yellow LED above the A-LOC [14] key. Play mode is automatically activated when the tape address 12.24.35 is reached.

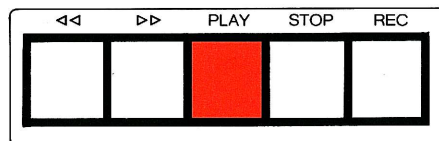
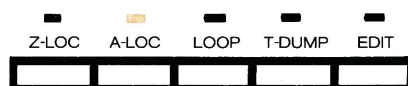

## Extended operation

### LOOP mode

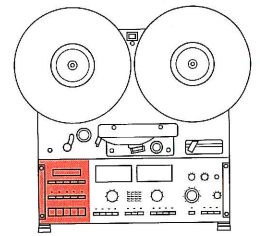

In LOOP mode it is possible to automatically repeat the playback of a certain tape segment or the entire tape. Proceed as follows:

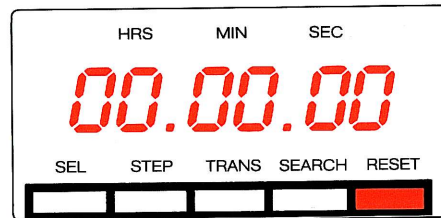

- At the position where the loop is to start, set the tape counter to zero by pressing the RE-SET [12] key.

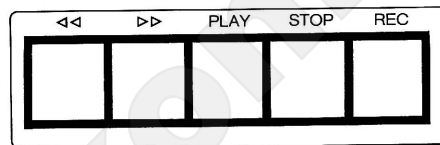
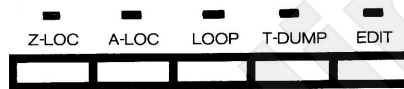

- Enter the ending address of the loop into the A-LOC as described under "Locator function".

- Press the LOOP [15] key. The yellow LED above this key lights up; the recorder positions at the tape address 12.24.35 and starts in play mode. When the ending loop address stored in the A-LOC is reached, the tape rewinds automatically and the entire process is repeated until cancelled.

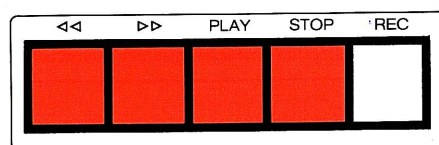
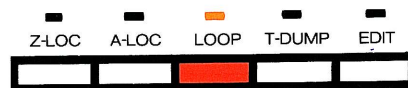

The LOOP function can be cancelled by selecting a tape transport function (<<, >>, PLAY, STOP) or by pressing the Z-LOC or A-LOC key. The selected function will be executed immediately.

#### Note:

If the tape address stored in the A-LOC is negative, the play mode starts at the address stored in the A-LOC and ends at tape address 00.00.00.

## Extended operation

### Waste basket mode (T-DUMP)

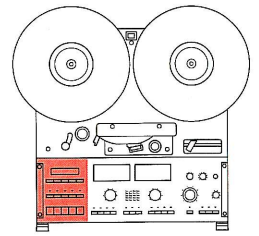

#### T-DUMP [16]

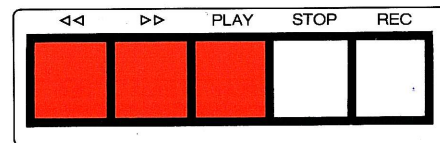
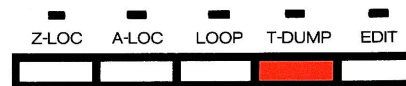
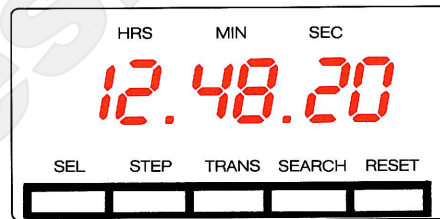
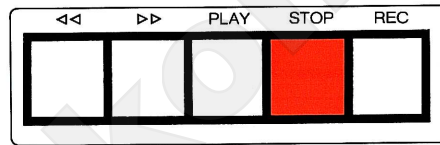
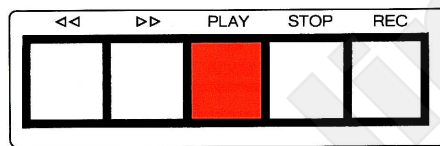
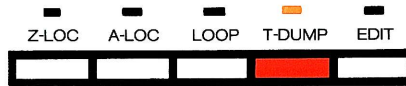

The T-DUMP [16] key activates the "waste basket" mode; the yellow LED above this key lights up. In this mode the right-hand spooling motor is switched off and unusable tape sections can thus be played into the "waste basket".

● When you press the PLAY [20] key, the tape is played but not wound. The tape section that is played into the waste basket can still be heard.

● Press the STOP [21] key. The play mode is interrupted and the tape stops.

● Press the T-DUMP [16] key again in order to cancel the waste basket mode; the yellow LED switches off.

● In order to retighten the loose tape, continuously press one of the spooling keys << [18] or >> [19] or PLAY [20]; the right-hand spindle [3] rotates slowly until the tape is again tensioned.

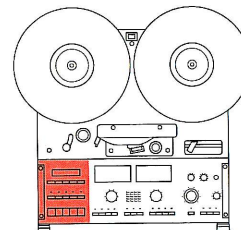

## Extended operation

### Editing function (EDIT)

#### EDIT [17]

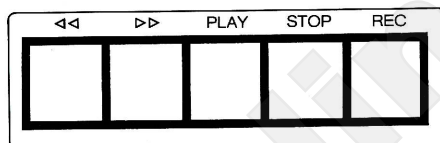
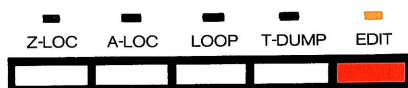
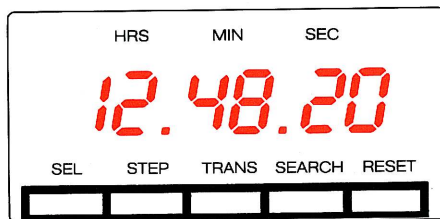

The EDIT [17] key activates the edit mode in which the tape can be accurately positioned by manually rotating the right-hand spindle [3]. The audio path is active in this mode which means that the recording is audible while the tape is being positioned.

- Press the EDIT [17] key. If the recorder is not in play or record mode, the edit mode is active and the yellow LED above this key lights up.

- Position the tape by turning the right-hand spindle [3] by hand. The tape tension functions correctly only if the right-hand spindle is used for editing.

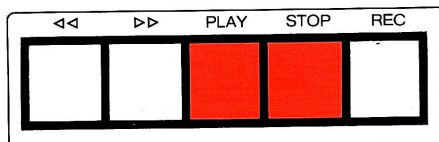
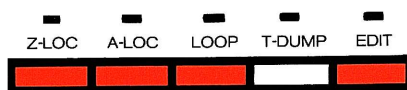

- To cancel the edit mode, press the EDIT [17] key again, or the PLAY [20], STOP [21], Z-LOC [13], A-LOC [14], or LOOP [15] key. The yellow LED above the EDIT [17] key switches off.

- In edit mode, positioning is also possible with the aid of the spooling motors by pressing the << [18] or >> [19] key. In this case the tape is transported at reduced speed and not lifted off the soundhead, i. e. the recording can be heard.

To extend the life of the tape and the soundheads, long tape sections should not be spooled in edit mode.

## Extended operation

### Tape scissors

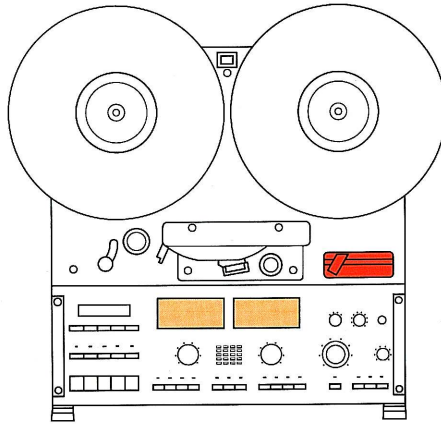
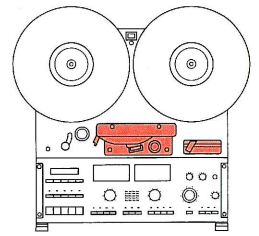

The tape can be cut quickly and neatly with the aid of the built-in antimagnetic tape scissors [48].

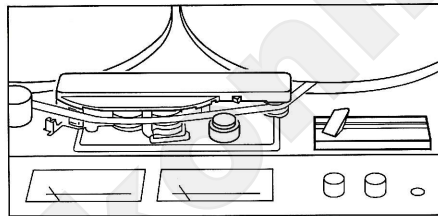

● In edit mode (EDIT [17] key pressed), position the tape exactly at the edit point.

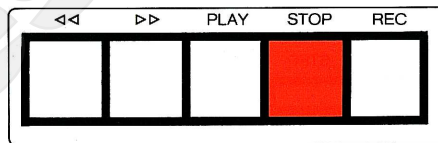

● Press the STOP [21] key in order to switch off the spooling motors.

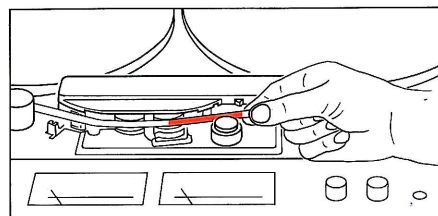

● Hold the tape between the index finger and thumb of your right hand at the mark [49] on the headblock housing.



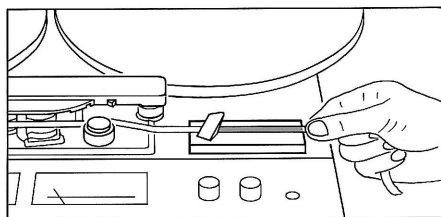

● Insert the tape into the splicing block of the scissors [48] in such a way that the index finger of your right hand is flush with the right-hand panel of the housing. The tape position which was previously located under the reproduce head gap is now exactly under the scissors.

www.eskonline.nl

## Extended operation

### Reproduce delay

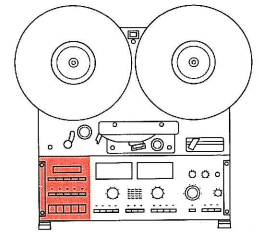

The play start of the C270 tape recorder can be delayed by fractions of a second in order to prevent reproduction of pitch variations caused by the acceleration of the capstan motor.

This delay can be user-defined and entered individually for each tape speed within the range of 0.00 s to 0.99 s.



- Enter programming mode by depressing speed selector [40–41] and SEL [8] button. The display [7] shows the selected tape speed in "ips" (inches per second), and in the SEC position the current reproduce delay in "ms" x10 (milliseconds x10). The first digit of the display flashes.

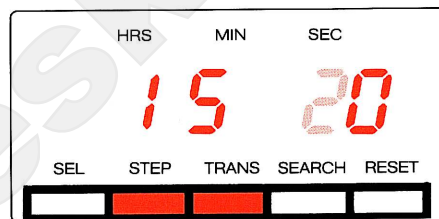

- The value of the flashing digit can be changed by pressing the STEP [9] key. Press the SEL [8] key again: the second digit of the delay time flashes and can be modified with the STEP [9] key.

- Press the TRANS [10] key: the stored reproduce delay is saved and activated. Repeat the same procedure for the second tape speed.

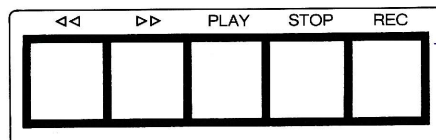
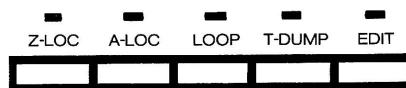

#### Note:

You can cancel the input procedure at any time by pressing the STOP [21] key. The displayed value multiplied by a factor of 10 gives the delay time in "ms" (milliseconds).

## Extended operation

### Automatic recording

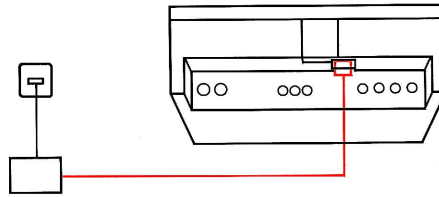
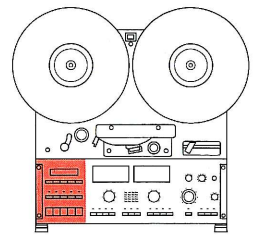

It is possible to automatically start a recording at the preset time by means of an external time switch. Connect the tape recorder to the AC outlet via a commercially available time switch and proceed follows:

- With the spooling keys, position the tape at the location where the recording should start.
- Prepare the recording by selecting the signal source (LINE [31] or MIC [29]) and in uncalibrated mode by adjusting the recording level with the level potentiometers INPUT CH1/CH2 [28/37].

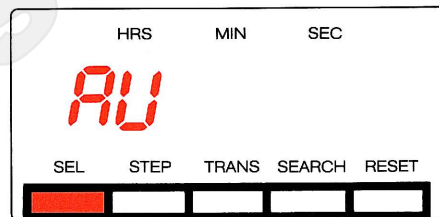
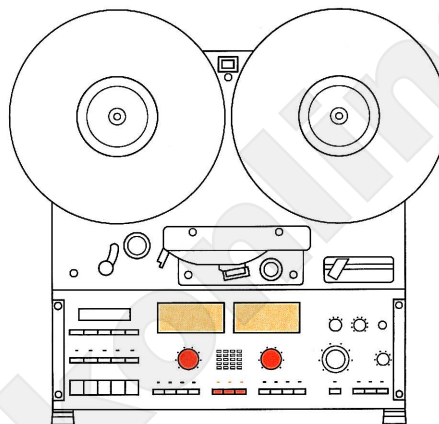

- Press the REC [22] key and simultaneously the SEL [8] key. The characters "AU" appear on the display [7].

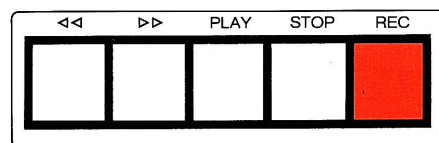
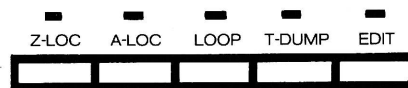

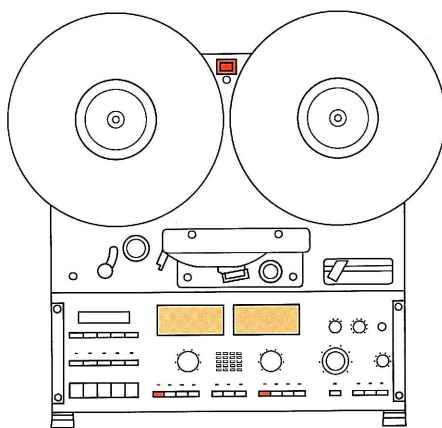

● Switch off the tape recorder. When the recorder is switched on again, the record mode is automatically activated. If neither of the two channels has been switched to READY [24/33] during the preparations, recording will take place on both channels. If only one of the channels has been switched to READY, only this one channel will record.

**Note:**

The automatic recording mode is activated only once and cancelled after it has been executed.

## SECTION 4

### Technical appendix

### Track configuration on the tape

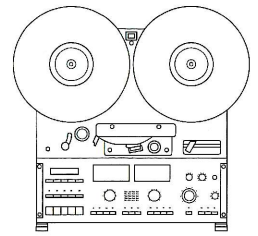

The REVOX C270 tape recorder is available in four versions:

- Stereo half-track (standard unit with 2 mm track separation)
- Stereo half-track RF (broadcast version with 0.75 mm track separation)
- Stereo quarter-track
- Mono full track

Only one type of recording can be made with each of the above versions. With a half-track machine, for example, stereo recordings can be made only in one tape direction.

#### Stereo half-track

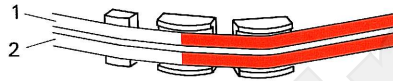

Stereo half-track refers to track configurations in which each stereo track occupies one half of the tape. When a stereophonic signal source is recorded (e. g. music from a stereo turntable), both tracks are always recorded concurrently. The left-hand channel (CH 1) is recorded on the upper track, the right-hand channel (CH 2) on the lower track. If mono recordings are made on such a unit, the signal should always be recorded simultaneously on both tracks.

#### Stereo half-track RF



The abbreviation RF designates the broadcast version of the stereo half-track machine. The only difference between this machine, which is principally intended for professional users, is that the track separation (gap between the two tracks) is 0.75 mm rather than 2 mm. The increase in the track width results in a greater dynamic range (range between peak level and tape hiss at low level). However, the frequency range is only influenced by the tape speed and not the width of the sound track.

#### Mono full-track

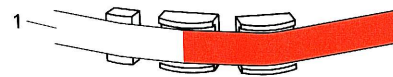

In mono full-track models the entire tape width is available for recording a single channel. This results in a greater dynamic range of the recording.

## Stereo quarter-track

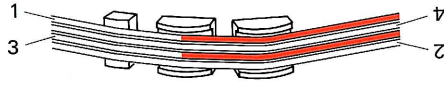

In this model the recording capacity of a tape is doubled. For this purpose the tape is subdivided into four narrower tracks. In one tape direction, the stereo signal is recorded on tracks 1 and 3.

The tape can then be reversed and recorded on tracks 2 and 4. When working with quarter-track models, the track location should always be noted together with the title, the tape speed, and the counter reading.

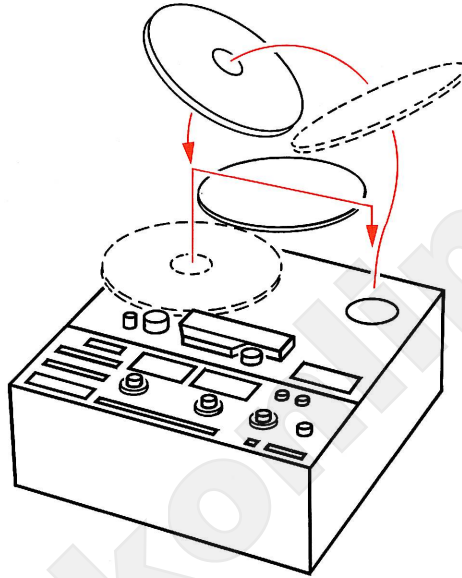

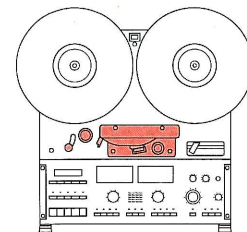

The C270 tape recorder requires no regular maintenance other than occasional cleaning of the capstan shaft, the pinch roller, the soundheads, and the tape guides, and demagnetization of all metal parts that come in contact with the tape. For this purpose we recommend the REVOX cleaning kit (Part No. 39000) and the REVOX demagnetizing choke (Part No. 10.042.002.01).

**Cleaning**

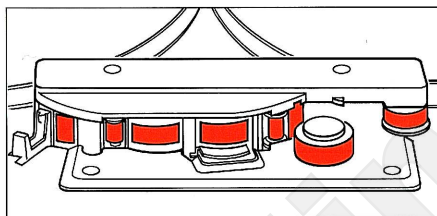

Moisten a felt stick with cleaning fluid and clean all tape guidance elements. Then dry the cleaned parts with a new, clean felt swab or cleaning web.

**Important:**  
Make sure that no cleaning fluid penetrates into the bearing of the capstan shaft or contacts the cover of the VU-meters because this would damage the bearings or the covers.

**Demagnetizing**

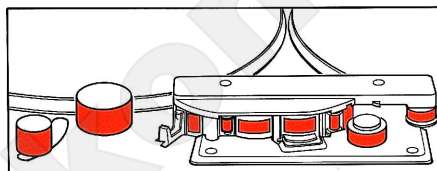

Switch off the tape recorder and remove the tape sufficiently far away from the recorder. Slowly approach the part to be demagnetized with the tip of the energized choke and after a brief moment retract it slowly. Repeat this procedure for all metal parts that come in contact with the tape (soundheads, tape guidance elements, guide rollers, lifting pin). Withdraw the choke from the recorder (approx. 50 cm) before you switch it off.

**Caution:**  
The demagnetizing choke also demagnetizes your recorded tapes if the choke comes close to the tapes!

www.esk...

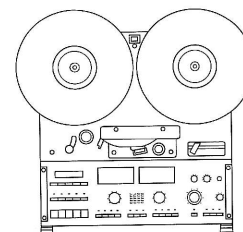

For correcting the frequency response, internationally standardized equalization networks are built into the record and reproduce path of the tape recorders.

The attack points of the correction are referred to as transition frequencies or transition time constants and depend on the tape speed. They have been standardized by various organizations (IEC, NAB, AES, CCIR) as follows:

TAPE SPEED	TRANSITION FREQUENCY, LOW AND HIGH (TRANSITION TIME CONSTANTS)	
	IEC - 1968	NAB - 1965
9,5 cm/s 3,75 ips	50 Hz; 1768 Hz (3180 μs; 90 μs)	50 Hz; 1768 Hz (3180 μs; 90 μs)
19 cm/s 7,5 ips	0 Hz; 2273 Hz (∞; 70 μs)	50 Hz; 3183 Hz (3180 μs; 50 μs)
38 cm/s 15 ips	0 Hz; 4547 Hz (∞; 35 μs)	50 Hz; 3183 Hz (3180 μs; 50 μs)

On the C270 tape recorder, the equalization networks are plugged into the RECORD EQUALIZER BOARD 1.777.540.00 and the REPRODUCE EQUALIZER BOARD 1.777.620.00. Due to this design it is possible to convert or recalibrate your recorder to different speeds or the other equalization standard.

www.eskonline.nl



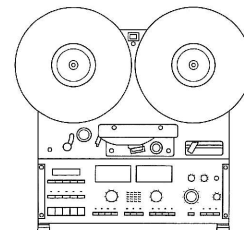

## Technical appendix

### Alternate tape speeds

The REVOX C270 tape recorders can easily be converted to other tape speeds. You will only need the corresponding plug-in boards for the desired tape speeds of the applicable equalization standard (IEC or NAB). The equalization networks for both channels (left and right) are implemented on one plug-in board each. This means that you will need one circuit board each for the record and the reproduce path.

TAPE SPEED	STANDARD	PART NO.:	PLUGGED IN ON:
9.5/19 cm/s 19/38 cm/s 9.5/38 cm/s	IEC IEC IEC	1.777.550.00 1.777.552.00 1.777.554.00	RECORD EQUALIZER BOARD RECORD EQUALIZER BOARD RECORD EQUALIZER BOARD
9.5/19 cm/s 19/38 cm/s 9.5/38 cm/s	NAB NAB NAB	1.777.556.00 1.777.558.00 1.777.559.00	RECORD EQUALIZER BOARD RECORD EQUALIZER BOARD RECORD EQUALIZER BOARD
9.5/19 cm/s 19/38 cm/s 9.5/38 cm/s	IEC IEC IEC	1.777.630.00 1.777.632.00 1.777.634.00	REPRODUCE EQUALIZER BOARD REPRODUCE EQUALIZER BOARD REPRODUCE EQUALIZER BOARD
9.5/19 cm/s 19/38 cm/s 9.5/38 cm/s	NAB NAB NAB	1.777.636.00 1.777.638.00 1.777.639.00	REPRODUCE EQUALIZER BOARD REPRODUCE EQUALIZER BOARD REPRODUCE EQUALIZER BOARD

● Disconnect the recorder from the AC supply and from all other units.

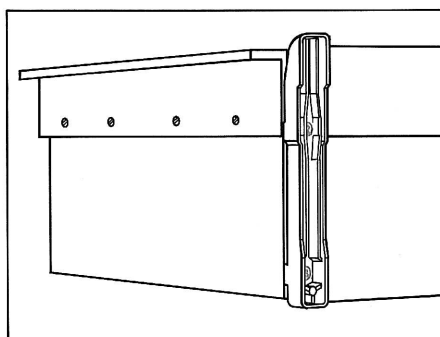

● Remove the two feet of the unit by unfastening the two screws accessible from the bottom.

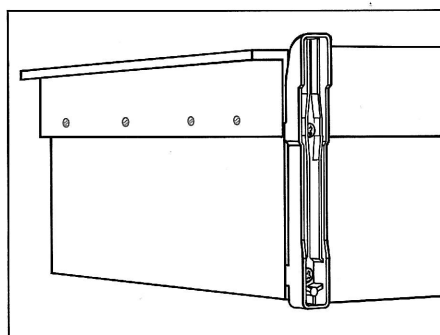

● Unfasten the eight fixing screws located on the side of the housing bay and remove the housing bay.

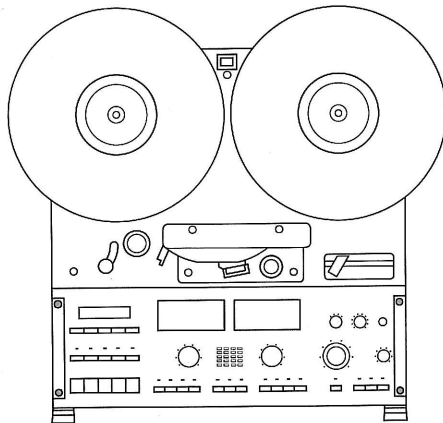

● Unfasten the four screws [50] of the control panel and swing the panel over the headblock. The control panel can be secured in this position by pressing it against the recorder.

● Refer to the UNIT LOCATIONS drawing in the set of diagrams (Section 1) in order to familiarize yourself with the layout of the unit and then pull the RECORD EQUALIZER BOARD 1.777.540.XX and the REPRODUCE EQUALIZER BOARD 1.777.620.XX out of the recorder. Replace the equalization boards located on these assemblies and reinstall them in the unit.

● The microprocessor of the tape recorder now must be told for which tape speed the unit has been equipped. Two microswitches on the CONTROL BOARD 1.777.400.XX have been provided for this purpose. The 8-position switch is readily accessible from the left-hand side of the unit. Set the switch positions 4 and 5 according to the table below while the recorder is switched off.

The status of the eight switches is only scanned when the recorder is switched on. In order to activate the parameter change, briefly switch the recorder off and on again.

SWITCH	POSITION		FUNCTION	
Nr. 2	ON		Auto rewind, can be activated with LOOP [15]	
Nr. 2	OFF *		Normal LOOP function, auto rewind off	
Nr. 3	ON		Library mode wind on	
Nr. 3	OFF *		Normal operation, library mode wind off	
Nr. 4	ON	OFF	9.5/19 cm/s	3.75/7.5 ips
Nr. 5	ON	OFF		
Nr. 4	ON		9.5/38 cm/s	3.75/15 ips
Nr. 5	OFF			
Nr. 4	OFF		9.5/19 cm/s	3.75/7.5 ips
Nr. 5	OFF			
Nr. 6	ON *		MIC/LINE SWITCH BOARD exists	
Nr. 6	OFF		MIC/LINE SWITCH BOARD does not exist	
Nr. 7	ON *		Normal operation, record function enabled	
Nr. 7	OFF		Recording inhibited, only play mode allowed	
Nr. 1	ON *		Normal recorder operation Fader start disabled ext. Varispeed disabled	
Nr. 8	ON *			
Nr. 1	ON		Fader start enabled	
Nr. 8	OFF			
Nr. 1	OFF		ext. Varispeed enabled	
Nr. 8	ON			

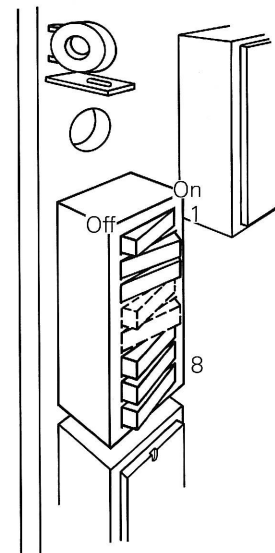

\* Basic ex-factory setting of the switches.



Your tape recorder has been factory-aligned exactly to specifications. In the following paragraphs you will not find any detailed instructions for calibration or recalibration of your machine but only a definition of the commonly used levels and measuring variables. Detailed calibration instructions can be found in the service instructions for the C270 tape recorder (order No.: 10.30.0920).

**Level definitions**

**Voltage level**

**0 dBm (= 0.775 V)**

This level has been derived from the 1 mW power level in any load resistance. The voltage drop across a 600 ohm load is 0.775 V. This voltage is defined as 0 dBm (regardless of the load).

**0 dBu (= 0.775 V)**

This level corresponds to a voltage of 0.775 V regardless of the load resistance. [dBu] is occasionally used in place of the voltage level [dBm].

**Line level**

The line level refers to the level that is

- available at the output of a tape recorder when a tape with reference fluxivity is being played, or
- fed into the input of a tape recorder when a recording produces reference fluxivity.

**Voltage reference level**

CCIR designation for line level; this level produces a reading of 0 dB on a quasi peak program meter (PPM).

**Standard reference level (operating level)**

A term commonly used in the USA for a tape flux of 250 nWb/m (for recording on high-output tapes) or 200 nWb/m (for recording on standard tapes); this level produces a VU-meter reading of 0 VU.

www.eskonline.nl

---

## Peak Level

A term commonly used in the USA for a level that is 8 to 10 dB higher than the operating level. For reasons of simplicity, a peak level of + 6 dB relative to operating level (double the voltage level) is used.

## IEC/CCIR calibration

DEFINITION:	LINE LEVEL [dBm]	VU-METER READING [dBm]
REFERENCE LEVEL:	0	0

## NAB calibration

DEFINITION:	LINE LEVEL [dBm]	VU-METER READING [dBm]
OPERATING LEVEL: "PEAK LEVEL":	+ 4 + 10	0 + 6

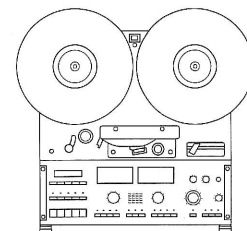

## Technical appendix

## Technical data

All tape dependent audio data refer to the tape types:  
IEC version: AGFA PEM 468  
NAB version: 3M 226

<b>Equipment type:</b>	2-channel tape recorder		
<b>Tape path:</b>	1/4" width (6.35 mm)		
<b>Tape transport:</b>	3-Motor transport: 2 controlled AC spooling motors, 1 Hall-commutated capstan motor, electronically controlled.		
<b>Tape speeds:</b>	9.5/19, 19/38 or 9.5/38 cm/s selectable via internal switches.		
<b>Tolerance of the nominal speed:</b>	±0.2%		
<b>Varispeed range:</b>	-33% to +50% of nominal speed		
<b>Wow and flutter:</b> (weighted according to DIN 45507)	hub diam.	hub diam.	
	≥10 cm	≥6 cm	
at 9.5 cm/s	<0.1%	<0.1%	
at 19 cm/s	<0.07%	<0.1%	
at 38 cm/s	<0.05%	<0.1%	
<b>Tape slip:</b>	max. 0.2%		
<b>Start-up time</b> (acc. to DIN):	max. 500 ms at 38 cm/s		
<b>Winding time:</b>	approx. 130 s for 1100 m tape approx. 90 s for 760 m tape		
<b>Reel size:</b>	max. diameter 265 mm		
<b>Tape deck control:</b>	microprocessor-controlled logic including tape end sensor, tacho roller status, and tape tension arm position. Tape dump and fader start possible.		
<b>Tape counter:</b>	Real-time indication in hours, minutes and seconds corresponding to the selected tape speed. Accuracy:		0.25%
	Zero locator, address locator and LOOP mode possible.		
<b>Equalizations:</b>	NAB and IEC as plug-in modules in record and reproduce path.		
	NAB 9.5 cm/s:	90 – 3180 μs	
	19 cm/s:	50 – 3180 μs	
	38 cm/s:	50 – 3180 μs	
	IEC 9.5 cm/s:	90 – 3180 μs	
	19 cm/s:	70 μs	
	38 cm/s:	35 μs	
<b>Frequency response:</b>	(with tape, at -20 VU)		
	at 9.5 cm/s	30 Hz ... 14 kHz	±2 dB
		50 Hz ... 8 kHz	±1 dB
	at 19 cm/s	30 Hz ... 18 kHz	±2 dB
		50 Hz ... 12 kHz	±1 dB
	at 38 cm/s	30 Hz ... 22 kHz	±2 dB
		50 Hz ... 16 kHz	±1 dB
<b>Frequency response for SYNC track reproduction:</b>	at 9.5 cm/s	100 Hz ... 5 kHz	+2/-3 dB
	at 19 cm/s	100 Hz ... 8 kHz	+2/-3 dB
	at 38 cm/s	100 Hz ... 12 kHz	+2/-3 dB
<b>Peak level recording:</b>	514 nWb/m corresponds to: +6 dB above 0 VU		
<b>Level meter:</b>	VU-meter according to ASA standard with peak LED's for levels of: +6, +9, +12 dB		
<b>Distortion:</b>	(k3 at 1 kHz)		
	9.5 cm/s (400 nWb/m)		<1.5%
	19 cm/s (514 nWb/m)		<1.2%
	38 cm/s (514 nWb/m)		<1.0%
<b>Signal-to-noise ratio:</b>	(with tape)		
	linear/A-weighted IEC 179		
	IEC version: 9.5 cm/s (400 nWb/m)		>56 dB/61 dB
	19 cm/s (514 nWb/m)		>58 dB/64 dB
	38 cm/s (514 nWb/m)		>59 dB/65 dB
	linear/A-weighted IEC 179		
	NAB version: 9.5 cm/s (400 nWb/m)		>56 dB/61 dB
	19 cm/s (514 nWb/m)		>60 dB/65 dB
	38 cm/s (514 nWb/m)		>59 dB/64 dB
<b>Cross-talk:</b>	Stereo at 1 kHz		>-50 dB
	Mono at 1 kHz		>-70 dB
<b>Erase depth:</b>	at 19 cm/s	better than -80 dB	
	at 38 cm/s	better than -75 dB	

<b>Inputs per channel:</b>	(0 dBu = 0.775 V)	
	LINE IN:	Balanced input (XLR) with isolation transformer, input resistance >5 kohm
		CAL (IEC): for 514 nWb/m + 6 dBu
		Adjustment range -10 ... +16 dBu
		CAL (NAB): for operation level (0 VU) + 4 dBu
		Adjustment range -10 ... +16 dBu
		UNCAL: possible increase +10 dB each
		Max. level: for f>40 Hz +22 dBu
<b>Microphone inputs:</b>	(retrofitable)	
		Balanced input (XLR) with isolation transformer
	Input impedance:	40 Hz ... 15 kHz >1.2 kohm
	Sensitivity: "LO" position	-70 dBu ... -36 dBu
	"HI" position	-38 dBu ... -8 dBu
	Max. level	-8 dBu
<b>Outputs per channel:</b>	(0 dBu = 0.775 V)	
	LINE OUT:	Balanced output (XLR) with isolation transformer, output impedance 80 ohm
		CAL (IEC): for 514 nWb/m, 600 Ohm + 6 dBu
		Adjustment range -20 ... +15 dBu
		CAL (NAB): for OP level (0 VU), 600 ohm + 4 dBu
		Adjustment range -20 ... +15 dBu
		UNCAL: possible increase +10 dB each
		Max. level: into 600 ohm +22 dBu
		into 200 ohm +20 dBu
<b>Phones:</b>	Jack socket diam. 6.3 mm, short-circuit-proof	
	Output voltage: at 514 nWb/m	max. 5.6 V
	for 0 VU	2.8 V
	Output impedance:	220 ohm
<b>Monitor:</b>	8-pin DIN socket	
	Output voltage: at 514 nWb/m	max. 1.8 V
	for external supply	+24 V
	Output impedance:	4.7 kohm
<b>RS-232:</b>	7-pin DIN socket, serial interface with 9600 baud, 24 V supply for manual remote control or external locator. Full-duplex, 3-wire connection (GND, Tx, Rx) 1 start bit, 1 stop bit, 8 data bits, no parity, software handshaking (Xon/Xoff).	
<b>Fader/Sync:</b>	8-pin DIN socket for fader start and synchronization of the capstan motor. Connection for data head.	
<b>Power inlet:</b>	3-poles with protective ground	
<b>Power requirements:</b>	(voltage selector) 100, 120, 140, 200, 220, 240 V AC 50 ... 60 Hz	
<b>Power consumption:</b>	max. 125 W	
<b>Power fuse:</b>	100 ... 140 V:	T 3.15 A/250 V (SLOW)
	200 ... 240 V:	T 1.6 A/250 V (SLOW)
<b>Operating conditions:</b>	ambient air temperature +10°C ... +40°C Relative humidity (DIN 40040) Category F	
<b>Operating position:</b>	any position between horizontal and vertical	
<b>Weight:</b>	Including rack brackets 23 kg	
<b>External dimensions:</b>	including rack brackets (W x H x D)	482 x 443 x 202 mm
	without rack brackets	434 x 443 x 202 mm
	Installation width including rack brackets	442 mm

Subject to change.

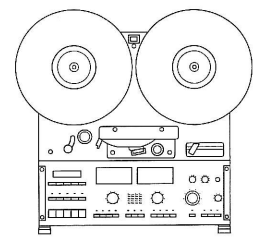

# Dimensions

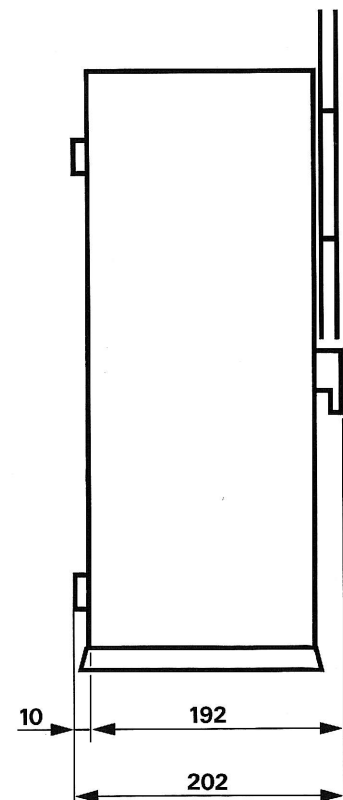
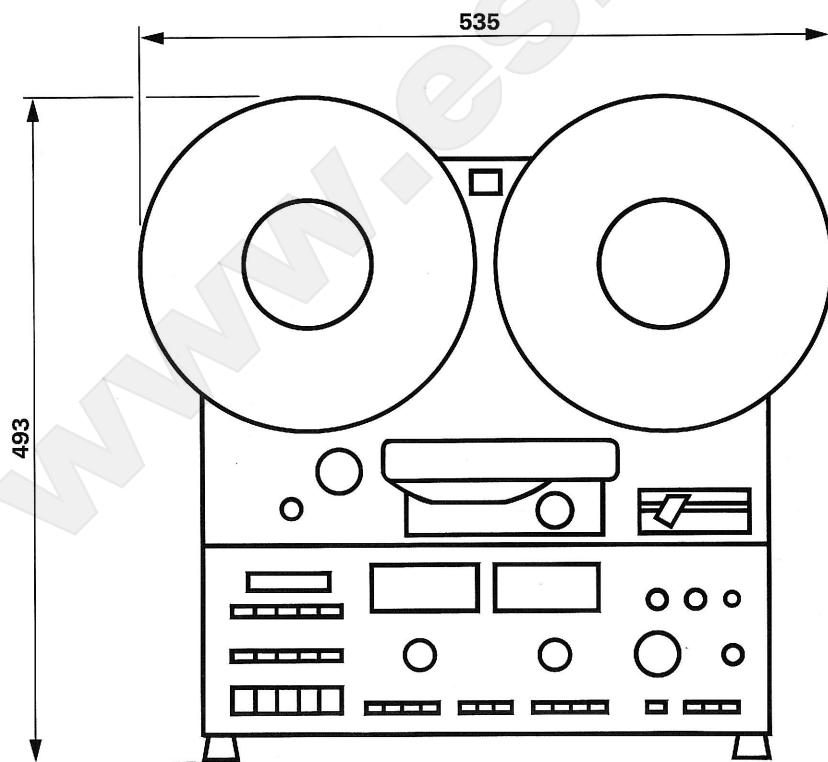
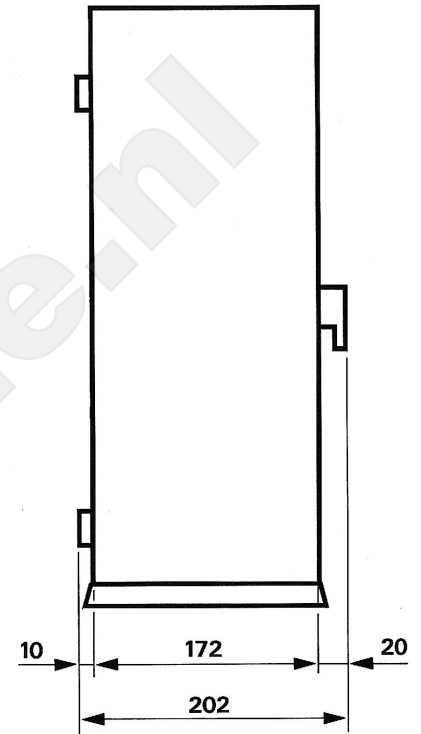
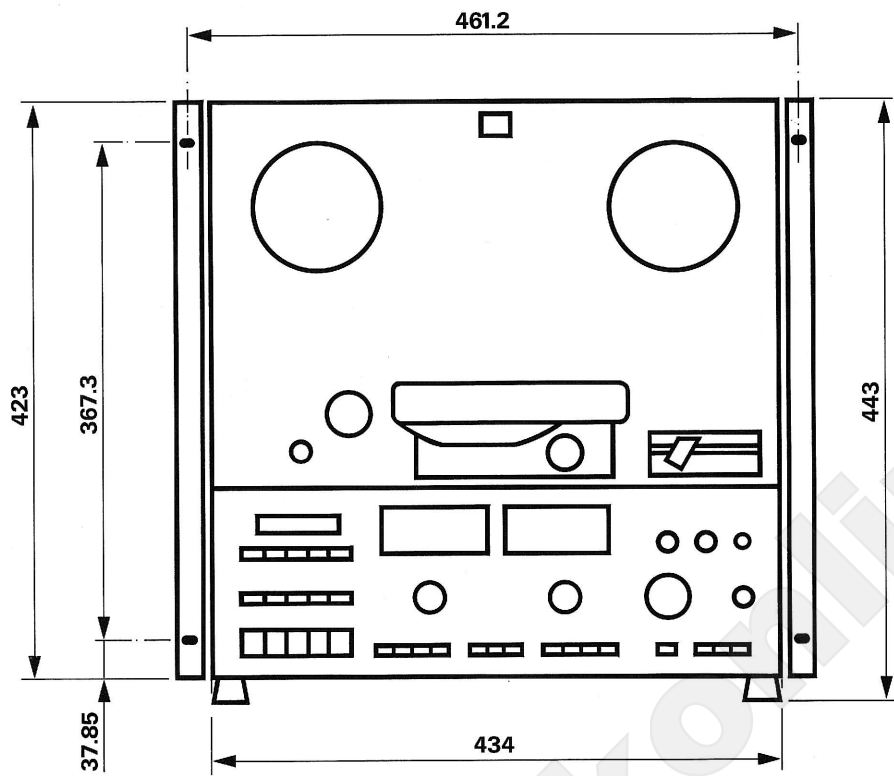

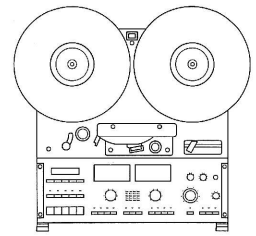

## Socket assignment

The sockets on the rear panel of the unit are wired in accordance with the following diagram. The sockets are drawn from the front. Connections not wired are to be kept free.

### XLR IN [56] [57]

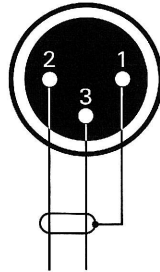

### XLR OUT [51] [52]

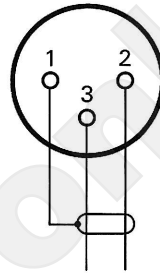

### MONITOR [53]

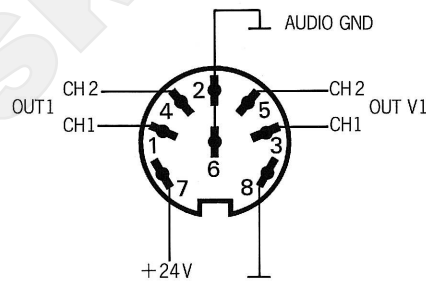

### FADER SYNC [54] FREE HEAD

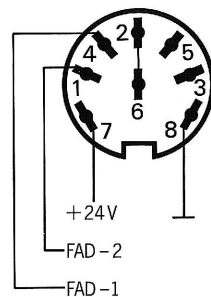

### RS-232 [55]

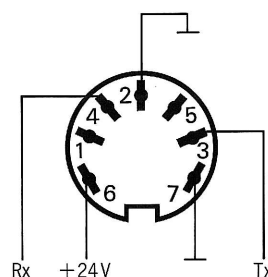

## SECTION 5

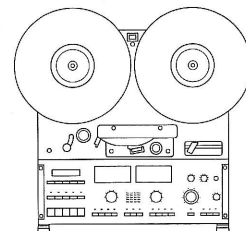

### Index of key functions

#### Front panel:

Element	Function	Page
[1] POWER	Power switch, switches the recorder on and off.	6
[2]	Left-hand spindle, supply motor.	
[3]	Right-hand spindle, take-up motor.	
[4]	Tacho roller for real-time counter.	
[5]	Light barrier for detecting the transparent tape leader or a torn tape.	
[6]	Tape sensor arm, controls the tape tension.	
[7]	Real-time counter, displays the actual playing time in hours, minutes, and seconds as well as system parameters.	
[8] SEL	Selection key, causes the content of the address locator to be displayed, selects one numeric position of the display for modification with the STEP [9] key.	17
[9] STEP	Step key, modifies the numeric display position selected with SEL [8] in one step increments.	17
[10] TRANS	Key for storing the tape position displayed on the real-time counter in the address locator (A-LOC). The displayed value can first be modified by means of the SEL [8] and STEP [9] keys.	17
[11] SEARCH	Positions the tape at the address defined on the display with the SEL [8] and STEP [9] keys without overwriting the old content of the address locator (A-LOC) with the new address.	18
[12] RESET	Reset key, resets the counter to zero (00.00.00).	19
[13] Z-LOC	Zero locator, positions the tape at the address 00.00.00. PLAY mode can be preselected.	16
[14] A-LOC	Address locator, positions the tape at the address stored in the A-LOC with the TRANS [11] key. PLAY mode can be preselected.	17
[15] LOOP	Activates the LOOP mode. The recorder plays the tape section endlessly between the tape address 00.00.00 and the address stored in the A-LOC. The address in the A-LOC can also be negative. This function can be cancelled by pressing the LOOP key again or any tape transport key.	19
[16] T-DUMP	Switches the waste basket (tape dump) mode on or off. The right-hand spooling motor is switched off; the unwanted tape sections can be played into the "waste basket" by means of the PLAY [20] function.	20
[17] EDIT	Switches the edit mode on or off. By rotating the right-hand spindle or by means of the keys << [18] or >> [19] the tape can be shuttled backward and forward in order to find a specific segment.	21
[18] <<	Rewind key for fast rewinding of the tape. The tape is wound on the left-hand pancake.	9
[19] >>	Fast forward key for spooling the tape forward. The tape is wound on the right-hand pancake.	9



Element	Function	Page
[20] PLAY	Reproduces the tape. Is used in conjunction with the REC [22] key for activating the record mode.	9
[21] STOP	Pressing of this key stops all tape transport functions and all selected modes except dump edit mode.	9
[22] REC	To be pressed together with PLAY [20] for enabling the record mode. Recordings can only be made on channels switched to READY.	9
[23]	VU-meter for indicating the level of channel 1 (left) with three peak level LEDs for +6, +9, and +12 dB.	6
[24] READY	Readies channel 1 (left) for recording. The red LED above the key flashes. During a recording, i. e. after REC [22] and PLAY [20] have been pressed, this LED is continuously lit.	12
[25] INPUT	Output selector. The input signal is indicated on the VU-meter [23] and can be heard via the monitor outputs.	11
[26] SYNC	Output selector. The recording is reproduced via the record head with degraded frequency response. Permits recording of channel 2 in synchronism with an existing recording on channel 1.	6
[27] REPRO	Output selector. The recording is reproduced via the reproduce sound-head. This function can also be activated while a recording is in progress so that the quality of a recording can be continually checked (tape/source monitoring). The signal from the reproduce head is also available on the VU-meter [23] and the monitor outputs.	10
[28] INPUT CH 1	Input level control for channel 1. In the UNCAL [30] position it influences the recording level of channel 1.	11
[29] MIC	Input selector. Activates the record mode via microphone (both channels). This function can only be selected if the tape recorder is equipped with the optional MIC/LINE SWITCH BOARD.	11
[30] UNCAL	Activates the uncalibrated record mode. The record level can be adjusted via the INPUT CH 1 [28] and INPUT CH 2 [37] level potentiometers. This mode is automatically activated by the input selector [29].	10
[31] LINE	Input selector. Activates the recording path via the LINE INPUT CH 1 and LINE INPUT CH 2. Recording with calibrated or uncalibrated (UNCAL [30]) level is possible in this mode.	10
[32]	VU-meter for indicating the level of channel 2 (right) with three peak level LEDs for +6, +9, and +12 dB.	
[33] READY	Readies channel 2 (right) for recording. The red LED above the key flashes. During a recording, i. e. after REC [22] and PLAY [20] have been pressed, this LED is continuously lit.	12
[34] INPUT	Input selector. The input signal is indicated on the VU-meter [32] and can be heard via the monitor outputs.	11
[35] SYNC	Output selector. The recording is reproduced via the record head with degraded frequency response. Permits recording of channel 1 in synchronism with an existing recording on channel 2.	6

Element	Function	Page
[36] REPRO	Output selector. The recording is reproduced via the reproduce sound-head. This function can also be activated while a recording is in progress so that the quality of a recording can be continually checked (tape/source monitoring). The signal from the reproduce head is also available to the VU-meter [32] and the monitor outputs.	10
[37] INPUT CH 2	Input level control for channel 2. In the UNCAL [30] position it influences the recording level of channel 2.	11
[38] OUTPUT CH 1/2	Output level potentiometer for channel 1 (inner knob) and channel 2 (outer ring). In the UNCAL [39] position of the reproduce amplifier, the output level of the LINE OUTPUT CH 1 and LINE OUTPUT CH 2 can be influenced by means of these level potentiometers.	10
[39] UNCAL	Activates the uncalibrated reproduce mode. The output level can be adjusted by means of the level potentiometers OUTPUT CH 1 and OUTPUT CH 2 [38].	11
[40] SLOW	Switches to the slower of the two available tape speeds. If this key is pressed continuously, the nominal tape speed is shown as "ips" (inches per second) on the display [7].	8
[41] FAST	Switches to the faster of the two available tape speeds. If this key is pressed continuously, the nominal tape speed is shown as "ips" (inches per second) on the display [7].	8
[42] VARIABLE	Activates the varispeed mode (variable tape speed). The tape speed can be influenced with the SPEED DEVIATION [43] potentiometer.	15
[43] SPEED DEVIATION	Potentiometer for varying the tape speed steplessly in varispeed mode (VARIABLE [42] key) within the range of - 33 % to + 50 % of the selected nominal speed.	15
[44] SELECTOR	Monitor selector switch. Influences the reproduction via the monitor speaker and the monitor outputs. The outputs LINE OUTPUT CH 1 and LINE OUTPUT CH 2 are not affected.	14
[45] PHONES	Phones socket. The built-in monitor speaker is switched off when the headphones are plugged in.	13
[46] VOLUME	Volume control. Varies the volume of the built-in monitor speaker as well as the headphones output. The monitor speaker can be switched on by pulling out this knob and switched off by pushing it in.	13
[47]	Pinch roller. Presses the tape against the capstan shaft. Optimum tape transport is only ensured if this roller is in perfect condition (undamaged).	29
[48]	Tape scissors and splicing block. Permits convenient cutting and splicing of the tape.	22
[49]	Cutting mark. If the tape is held in this position and inserted into the splicing block [48] in such a way that the position on which the cutting mark was located is aligned with the right-hand side of the housing, that tape address will be located under the scissors which previously was located before the head gap of the reproduce head.	22
[50]	Fixing screws of the control panel.	32

---

**Rear panel:**

Element	Connection parts	Page
[51] LINE OUTPUT CH 2	Channel 2 output. The output level can be set with level controller OUTPUT CH 1/2 [38].	5
[52] LINE OUTPUT CH 1	Channel 1 output. The output level can be set with level controller OUTPUT CH 1/2 [38].	5
[53] MONITOR	Output for an auxiliary monitor amplifier with speakers.	13
[54] FADER/SYNC	TTL signal (0 V/+ 5 V) input for external control of tape speed within the range - 33% to + 50%. Control frequency for nominal speed: 9.6 kHz.	15
[55] RS-232	Socket for serial connection RS-232, 9600 Baud.	
[56] LINE INPUT CH 2	Channel 2 signal source (amplifier, mixing console) line input (XLR balanced).	5
[57] LINE INPUT CH 1	Channel 1 signal source (amplifier, mixing console) line input (XLR balanced).	5
[58] MIC INPUT CH 2	Channel 2 microphone line input (XLR, balanced).	11
[59] MIC INPUT CH 1	Channel 1 microphone line input (XLR, balanced).	11
[60] AC POWER	Power connection and voltage selector.	25

## Correct insertion of the tape

### General

The data are stored on the inner side of the tape, i. e. on the side which is facing the head. The tape, being wound onto the reel only loosely, is not well protected and may easily get damaged.

Therefore, it is recommended to load the tape into the machine in accordance with the following instructions:

### Insertion of the tape

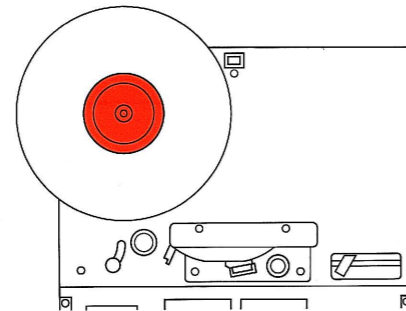

Place a full tape reel onto the left-hand spooling motor.

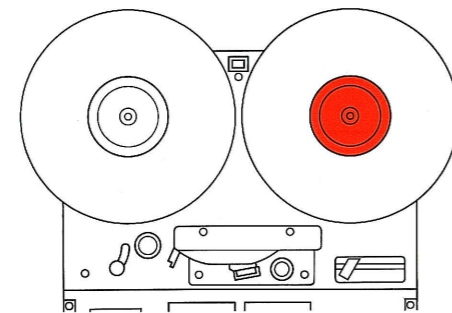

Place an empty reel onto the right-hand spooling motor.

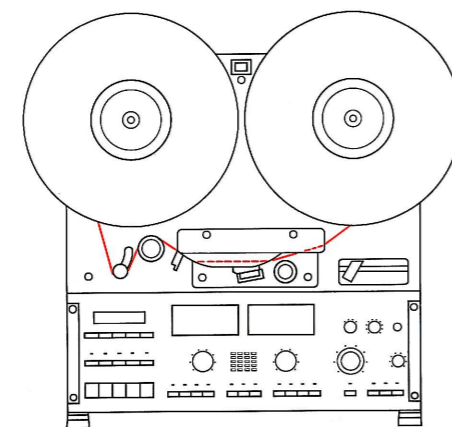

Both reels must be secured as per the adapter variants described on page 7.

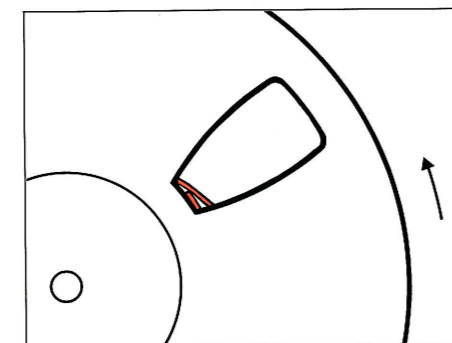

Put the head end of the tape against the hub of the right-hand tape reel and fix it to the hub by making one full turn.

### Fixation of the tape

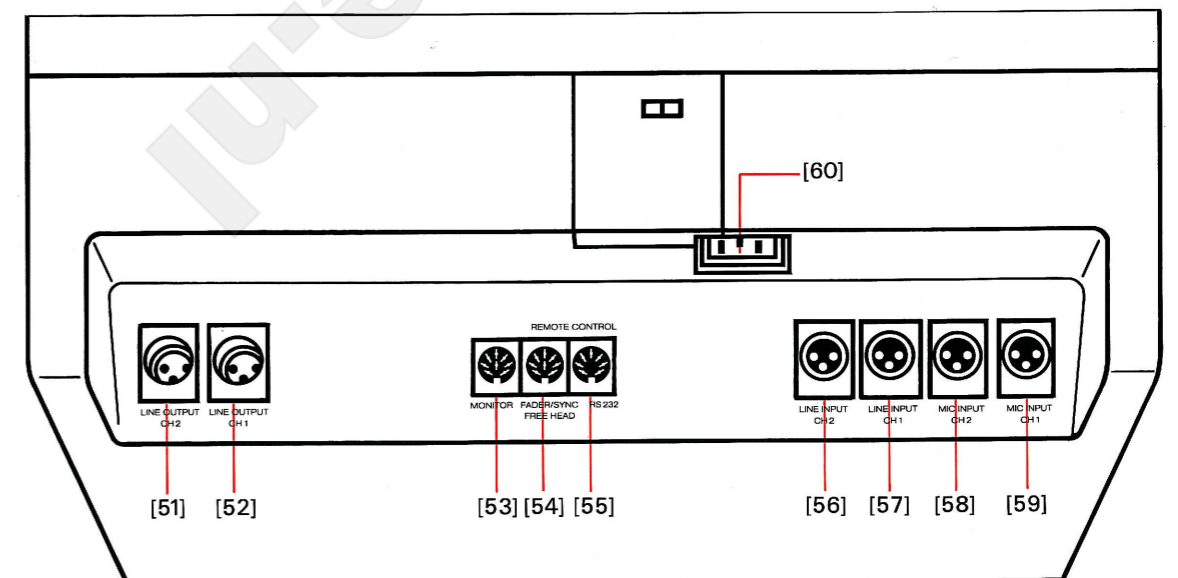
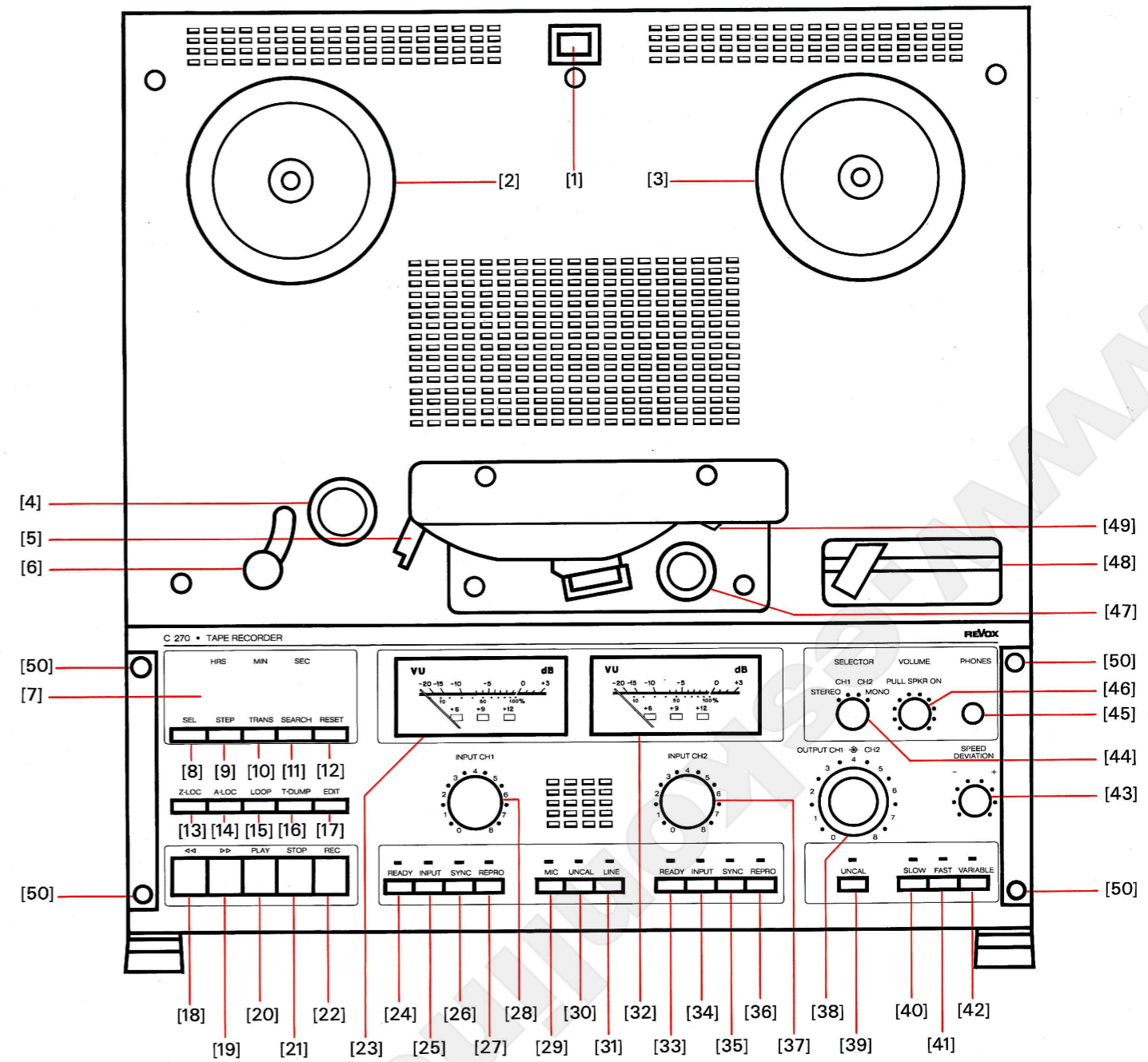

# Audio block diagram

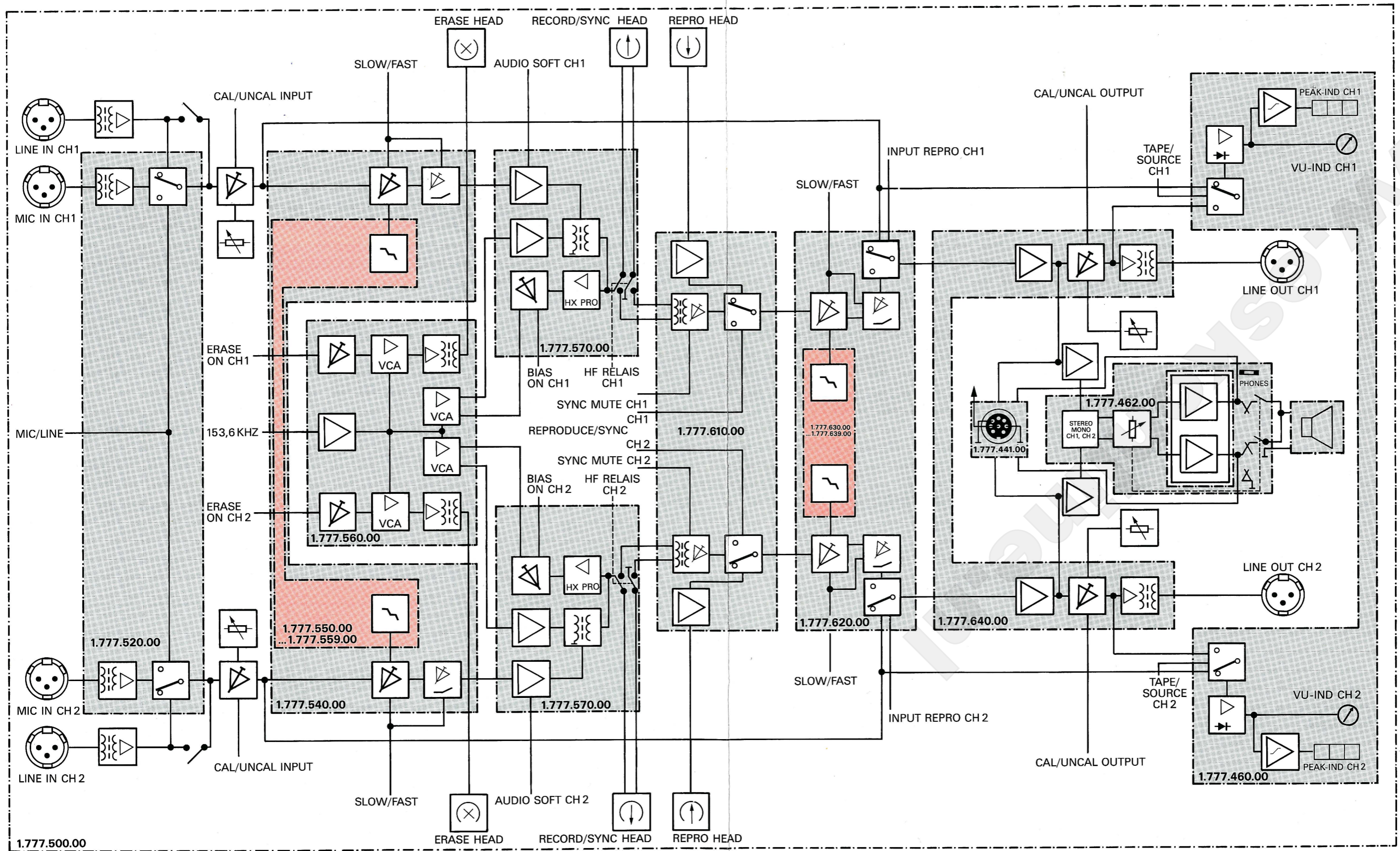

**Manufacturer**

Willi Studer AG  
CH-8105 Regensdorf/Switzerland  
Althardstrasse 30

Studer Revox GmbH  
D-7827 Löffingen/Germany  
Talstrasse 7

**Worldwide Distribution**

Revox Ela AG  
CH-8105 Regensdorf/Switzerland  
Althardstrasse 146

[www.eskonline.nl](http://www.eskonline.nl)