

ESL Series

USER MANUAL



ESL 2805

ESL 2905

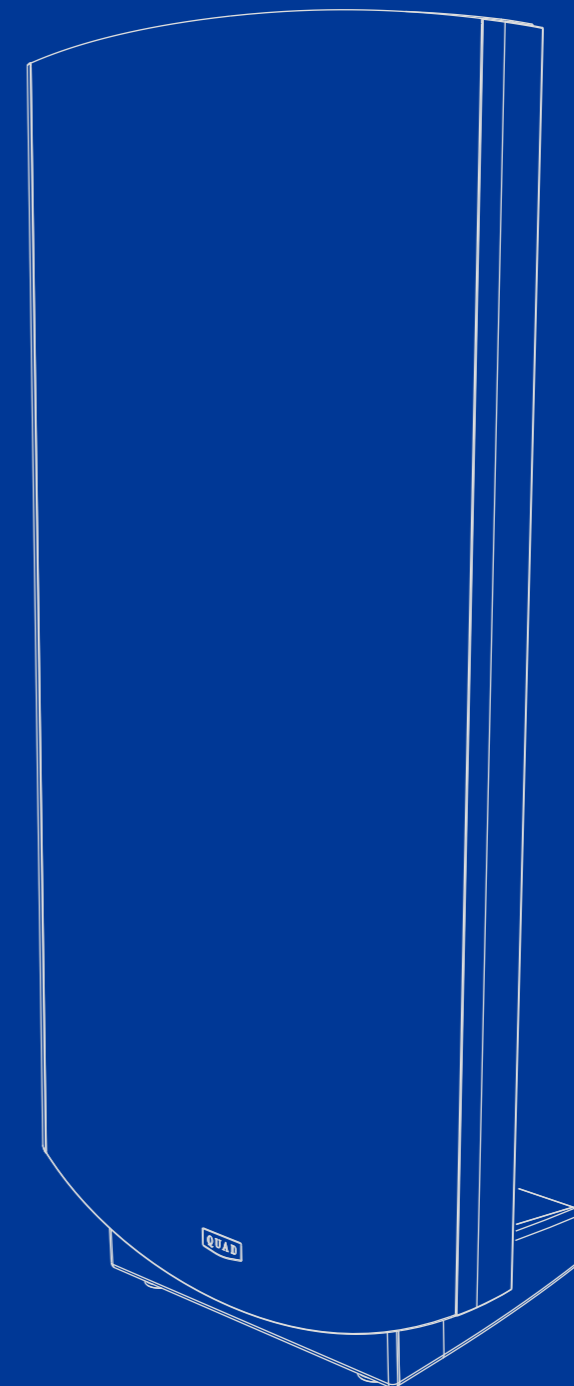

Quad Electroacoustics Ltd.
IAG House, Sovereign Court,
Ermine Business Park,
Huntingdon PE29 6XU. England.
Tel : 0845 458 0011 / +44 (0) 1480 447700
Fax : +44 (0) 1480 431767
www.quad-hifi.co.uk

User Cautions

 <div style="background-color: black; color: white; padding: 2px; font-weight: bold; font-size: 0.8em;">CAUTION!</div> <div style="border: 1px solid black; padding: 2px; font-size: 0.7em;">RISK OF ELECTRIC SHOCK DO NOT OPEN</div> 
<p>TO REDUCE THE RISK OF ELECTRIC SHOCK DO NOT REMOVE COVER (OR BACK) NO USER-REMOVEABLE PARTS INSIDE REFER SERVICING TO QUALIFIED PERSONNEL</p>
<p>ADVERTISSEMENT: RISQUE DE CHOC ELECTRIQUE- NE PAS OUVRIR</p>



This symbol indicates that there are important operating and maintenance instructions in the literature accompanying this unit.



This symbol indicates that dangerous voltage constituting a risk of electric shock is present within this unit.

IMPORTANT SAFETY INFORMATION

Read these instructions.

Keep these instructions.

Heed all warnings.

Follow all instructions.

Do not use this apparatus near water.

Clean only with dry cloth.

Do not block any ventilation openings.

Install in accordance with the manufacturer's instructions.

Do not install near any heat sources such as radiators, heat registers, stoves, or other apparatus (including amplifiers) that produce heat.

Do not defeat the safety purpose of the polarized or grounding type plug. A polarized plug has two blades with one wider than the other. A grounding type plug has two blades and a third grounding prong. The wider blade or the third prong are provided for your safety. If the provided plug does not fit into your outlet, consult an electrician for replacement of the obsolete outlet.

Protect the power cord from being walked on or pinched, particularly at plugs, convenience receptacles, and the point where they exit from the apparatus.

Use only attachments/accessories specified by the manufacturer.



Use only with a cart, stand, tripod, bracket, or table specified by the manufacturer, or sold with the apparatus. When a cart is used, use caution when moving the cart/apparatus combination to avoid injury from tip-over.

Unplug this apparatus during lightning storms or when unused for long periods of time.

Refer all servicing to qualified service personnel. Servicing is required when the apparatus has been damaged in any way, such as power-supply cord or plug is damaged, liquid has been spilled or objects have fallen into the apparatus, the apparatus has been exposed to rain or moisture, does not operate normally, or has been dropped.

Warning: To reduce the risk of fire or electrical shock, do not expose this product to rain or moisture. The product must not be exposed to dripping and splashing and no object filled with liquids - such as a vase of flowers - should be placed on the product.

No naked flame sources such as candles should be placed on

the product.

Caution: Changes or modifications not expressly approved by the manufacturer could void the user's authority to operate this device.

Warning: The mains power switch for this appliance is located on the rear panel. To permit free access to this switch, the apparatus must be located in an open area without any obstructions.

NOTE: This equipment generates, uses and can radiate radio frequency energy and, if not installed and used in accordance with the instructions, may cause harmful interference to radio communications. However, there is no guarantee that interference will not occur in a particular installation. If this equipment does cause harmful interference to radio or television reception, which can be determined by turning the equipment off and on, the user is encouraged to try to correct the interference by one or more of the following measures:

- Reorient or relocate the receiving antenna.
- Increase the separation between the equipment and receiver.
- Connect the equipment into an outlet on a circuit different from that to which the receiver is connected.
- Consult the dealer or an experienced radio/TV technician for help.

IMPORTANT NOTICE TO UK USERS

The appliance cord is terminated with a UK approved mains plug fitted with a 3A fuse. If the fuse needs to be replaced, an ASTA or BSI approved BS1362 fuse rated at 3A must be used. If you need to change the mains plug, remove the fuse and dispose of this plug safely *immediately* after cutting it from the cord.

Connecting a Mains Plug

The wires in the mains lead are coloured in accordance with the code: Blue: NEUTRAL, Brown: LIVE:

As these colours may not correspond to the coloured markings identifying the terminals in your plug, proceed as follows:

The BLUE wire must be connected to the terminal marked with the letter N or coloured BLUE or BLACK.

The BROWN wire must be connected to the terminal marked with the letter L or coloured BROWN or RED.

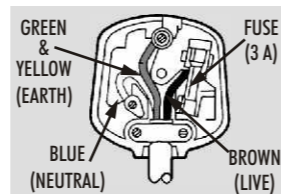

Warnings

The base stabiliser is a safety feature and must be securely attached to the product in accordance with the installation instructions. Alternatively the speaker may be securely attached to the floor. No other form of operation is permissible.

Quad ESL loudspeakers have very high internal voltages. No attempt should be made to remove the protective grilles or the baseplate. Amplifiers which are not short circuit protected may be damaged by the protection circuits in this loudspeaker and should not be used.

The Closest Approach

Quad - The Closest Approach by Ken Kessler

A 240 page hard-back, authoritative history with commentaries and contributions from every corner of the hi-fi industry. Technical chapters from Tim De Paravicini and Gordon Hill and interviews with Peter Walker, Ross Walker, Stan Curtis and Mike Albinson. Along with a series of stunning new photographs, fascinating historic documents and reproductions of AES and other technical papers, this is the definitive guide to the history and achievements of Quad.

Available through all good book retailers or any of our Dealers, from the Hi-Fi News Accessory Club, the Hi-Fi Collective, or the Quad Service Department

ISBN number 0-9545742-0-6

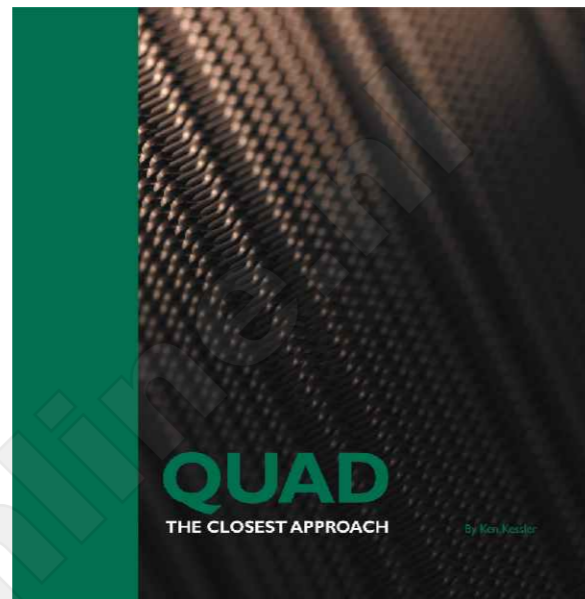

Introduction

Congratulations, you have become the owner of a pair of QUAD ESL loudspeakers.

For 50 years Quad Electroacoustics has produced the world's finest loudspeakers, considered by many to be the most accurate and neutral of all loudspeakers.

The ESL 2805 and 2905 represent the latest evolution of the unique Quad electrostatic concept. Radically redesigned using the most up to date materials and processes, these new evocations of our design philosophy achieve levels of detail, clarity and perspective that will be a revelation and source of continuing delight to all music lovers.

The ESL loudspeaker is a doublet or dipole, which produces a spherical sound field from a point source. All naturally created sounds emanate from a point source and the ESL speaker concept more nearly recreates this point source effect than any other speaker currently available. Another key feature of our unique linear motion design is very low distortion - your Quad ESLs are probably the lowest distortion loudspeakers ever made - and this includes the bass region where conventional speakers suffer from time related delays and associated distortions.

The result is a loudspeaker of unsurpassed accuracy and one which has stood the test of time. Major recording studios have ESLs amongst their reference monitoring loudspeakers and our loudspeakers are consistently in demand by audiophiles who value the clear natural sound that is uniquely the hallmark of all QUAD products.



Contents

CAUTIONS	IFC
INTRODUCTION	1
WHAT'S IN THE BOX	2
UNPACKING THE EQUIPMENT	3
POSITIONING THE LOUDSPEAKERS	4
CONNECTING THE LOUDSPEAKERS	5
OPERATION	6
FINAL ADJUSTMENTS	7
SPECIFICATIONS	8
MAINTENANCE AND SERVICE	11
QUALITY ASSURANCE	12
ABOUT YOUR LOUDSPEAKER	13
MAKING AN ELECTROSTATIC LOUDSPEAKER	14
THE CLOSEST APPROACH	16

The Making of a Quad Electrostatic Loudspeaker

At Quad we pride ourselves on our long tradition of impeccable craftsmanship.

Here are just some of the stages an ESL goes through on its long journey into your home. At every stage the most rigid standards of construction and inspection are applied, in clinically dust free conditions, to ensure that every loudspeaker maintains its performance over time.

This rigorous attention to minutiae is what makes Quad unique. In a world of near-instant obsolescence there is no junk-pile of Quad products - anywhere. Almost every product we have ever made is still in daily use - somewhere; some are now well over fifty years old, and still giving pleasure to their proud owners.

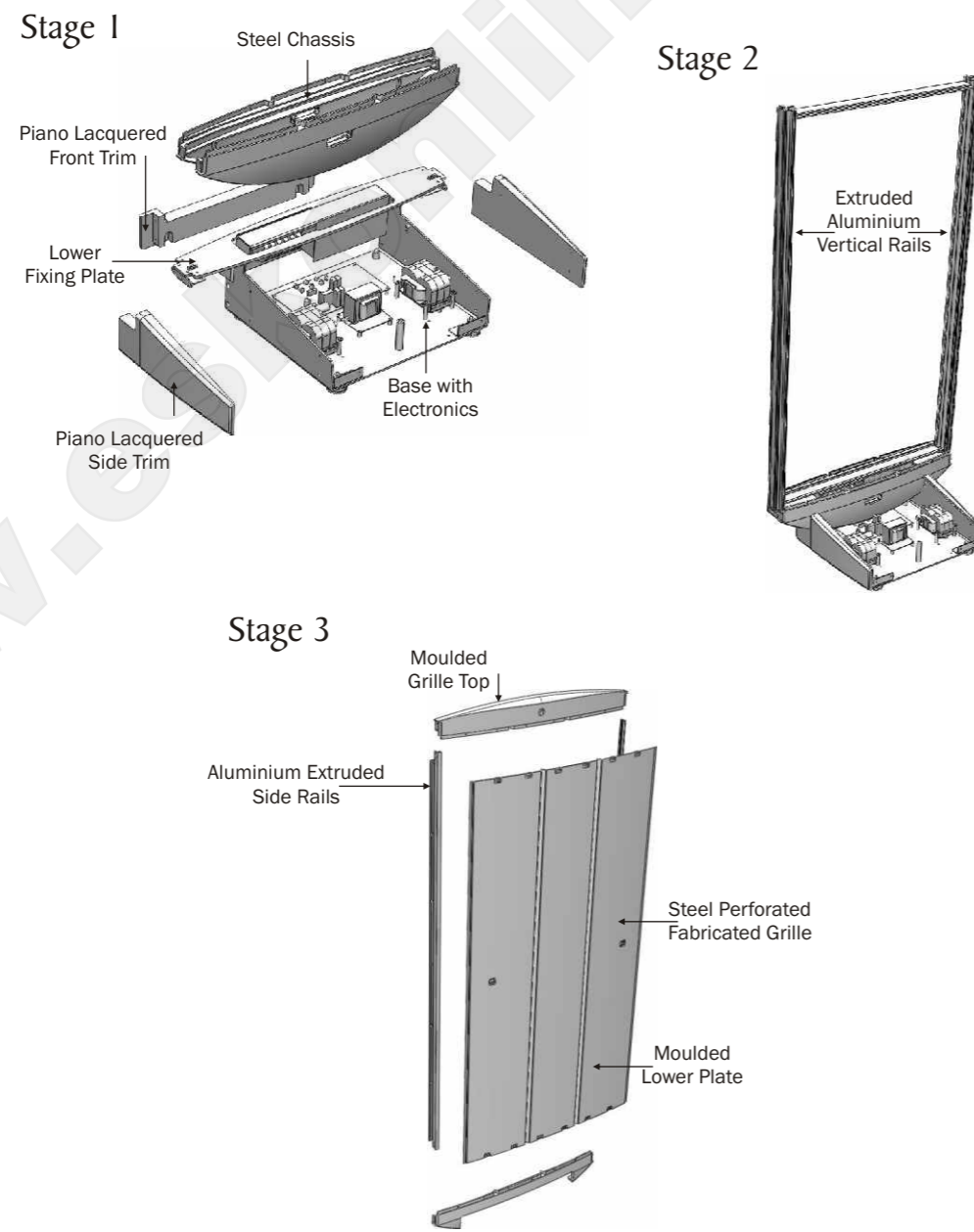

Unpacking and Assembly

These loudspeakers are heavy! It needs two people to lift and manoeuvre the loudspeakers into position. **DO NOT USE THE TENSIONING BRACE TO LIFT OR MANOEUVRE THE ESL OR YOU WILL DAMAGE THE LOUDSPEAKER!** WHEN MOVING THE LOUDSPEAKER HOLD IT BY THE SIDES OR THE SIDES AND BASE. Always use the supplied cotton gloves when handling exposed surfaces.

Before you unpack the loudspeakers, ensure that you have a large and completely clear area of floor on which to work. Remove or protect any fragile carpets, etc to avoid any damage.

Each ESL loudspeaker is packed in a cardboard outer carton and then packed on a pallet for safe transportation. The carton has a lidded top and a tabbed seam down one long edge which is taped over.

Place the speaker upright, standing on its wooden pallet. Open the top first, and then open the tabbed seam all the way down. Remove the top packing insert, and then remove the box containing the accessories. Remove the side packing pieces. The loudspeaker may now be lifted out of the base packing.

The stabiliser block is strapped to one of the side packing pieces. Cut the ties and remove the block.

Caution The block is heavy - exercise care.

The ESLs are provided with both spiked and standard feet which screw into the threaded holes in the baseplate. The heights of individual feet can be adjusted to ensure that the loudspeaker sits secure and level on the floor. Determine whether you will be using the spiked or the standard feet. Remember that spiked feet are only suitable for use with carpets as they will damage wood and stone floors. When using spikes take care to avoid the tips which are quite sharp.



Gently lay the loudspeaker down on its front. If the floor surface is hard place a soft cloth such as a towel under the speaker first. Spin one collar onto each foot all the way down but do not tighten.

Attaching the front feet: Insert the two front feet in the threaded inserts on the base and thread them fully in but only hand-tighten them at this stage. Refer to Illustration A below

Attaching the stabiliser and rear feet: It is essential that you attach the stabiliser as this is both a safety and operational feature. (As an alternative the speaker may be attached to the floor - see Page 7)

First, attach the two clamps to the block using the provided screws and shakeproof washers. Line up the assembly with the mounting holes in the base. Insert the feet through the support brackets and thread them into the base. Ensure that the feet protrude below the clamps by an equal distance. When the speaker is operational the weight/clamp assembly should be clear of the floor surface. Tighten both rear feet. Insert the collar locking bar into a hole in the clamping ring and tighten. Progressively move the bar from hole to hole until the feet are fully locked in place. Refer to Illustration B below

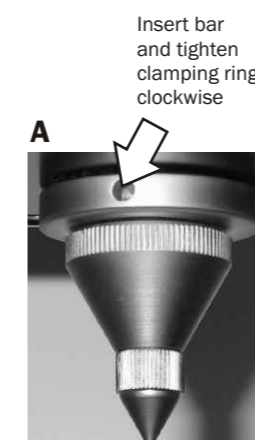

B Attaching the stabiliser and rear feet



Q is for Quality

Quad's attention to detail and standards of quality management are a byword in the hi-fi industry.

The finest C-core transformers are used in the audio path providing excellent linearity, wide bandwidth and very low phase shift.

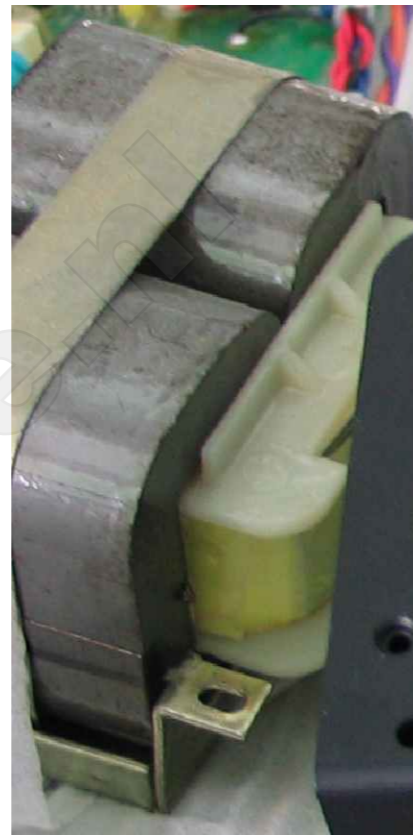

Inspecting a panel

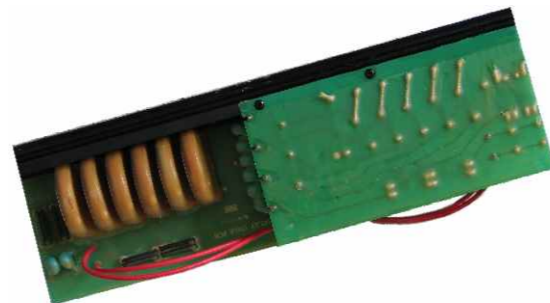

Section of a panel - note the concentric rings.

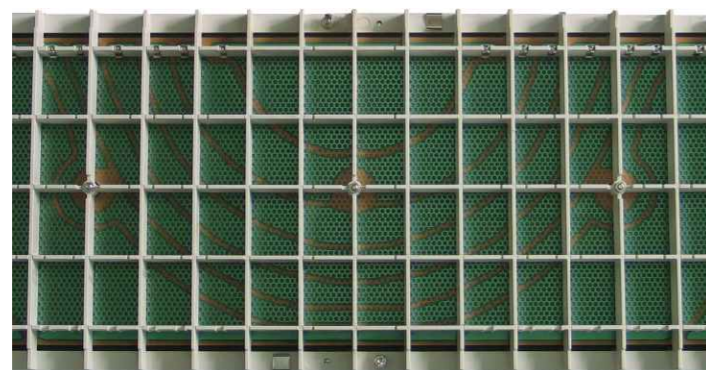

The delay line - the ingenious solution that gives the ESL its legendary point-source capability.

Choosing and Preparing Loudspeaker Cable

Specialist audio cable will usually offer better performance than general purpose 'bell' or 'zip' wire. Audio cable is polarised, with two cores of different colours, or often, in the case of twin cable, a coloured tracer or ridge along one wire to indicate polarity. Choose a cable of suitable diameter - cable that is too thin will limit the dynamics of the sound and may impair the bass response. Split the twin cores to a depth of about 25mm. Carefully strip the insulation from each end, leaving about 7mm of bare wire. If the cable is stranded, lightly twist to gather any loose strands.

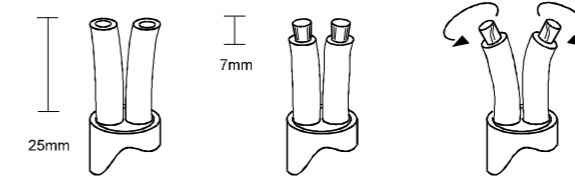

Connecting Your Loudspeakers

Lift the cover off the connections panel box and store it safely until you have finished connecting the speakers. The cover is magnetic for easy removal and replacement.

Choose an equal length of twin core speaker cable for each channel, and prepare the ends as described above. Unscrew each speaker terminal. Thread the bared end of each cable through the hole in the bottom of the terminal post. Ensure that there are no loose strands which may touch adjacent terminals. Retighten the terminal securely.



Connect the positive(+) terminal of the Left loudspeaker to the corresponding positive(+) amplifier terminal. Connect the negative(-) terminals similarly. Repeat this procedure for the Right Channel. Note that the positive(+) terminals are located on the right.

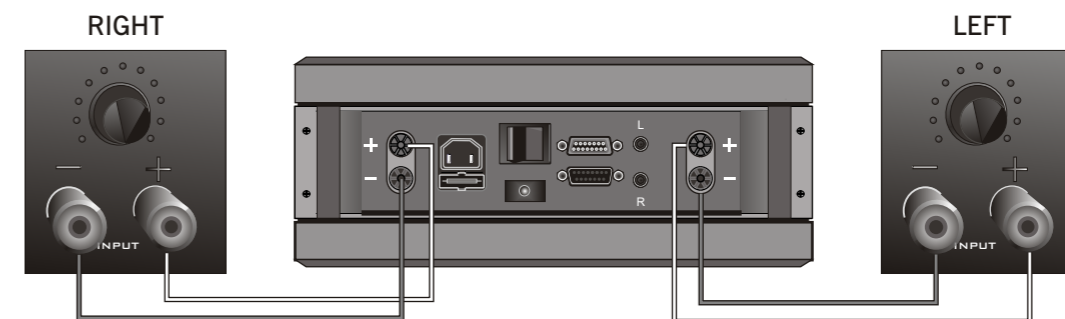

Phase

If there is any doubt about the way the loudspeakers are connected, their phasing can easily be checked by playing a mono source - the sound should appear to emanate from a point midway between the two loudspeakers. If this is indefinite, then the connections to one of the loudspeakers should be reversed. When correctly connected, the loudspeakers will give a definite centre sound source with more full bodied tenor and bass registers.

Horizontal Directivity

► Quad ESL-2905

Horizontal Directivity

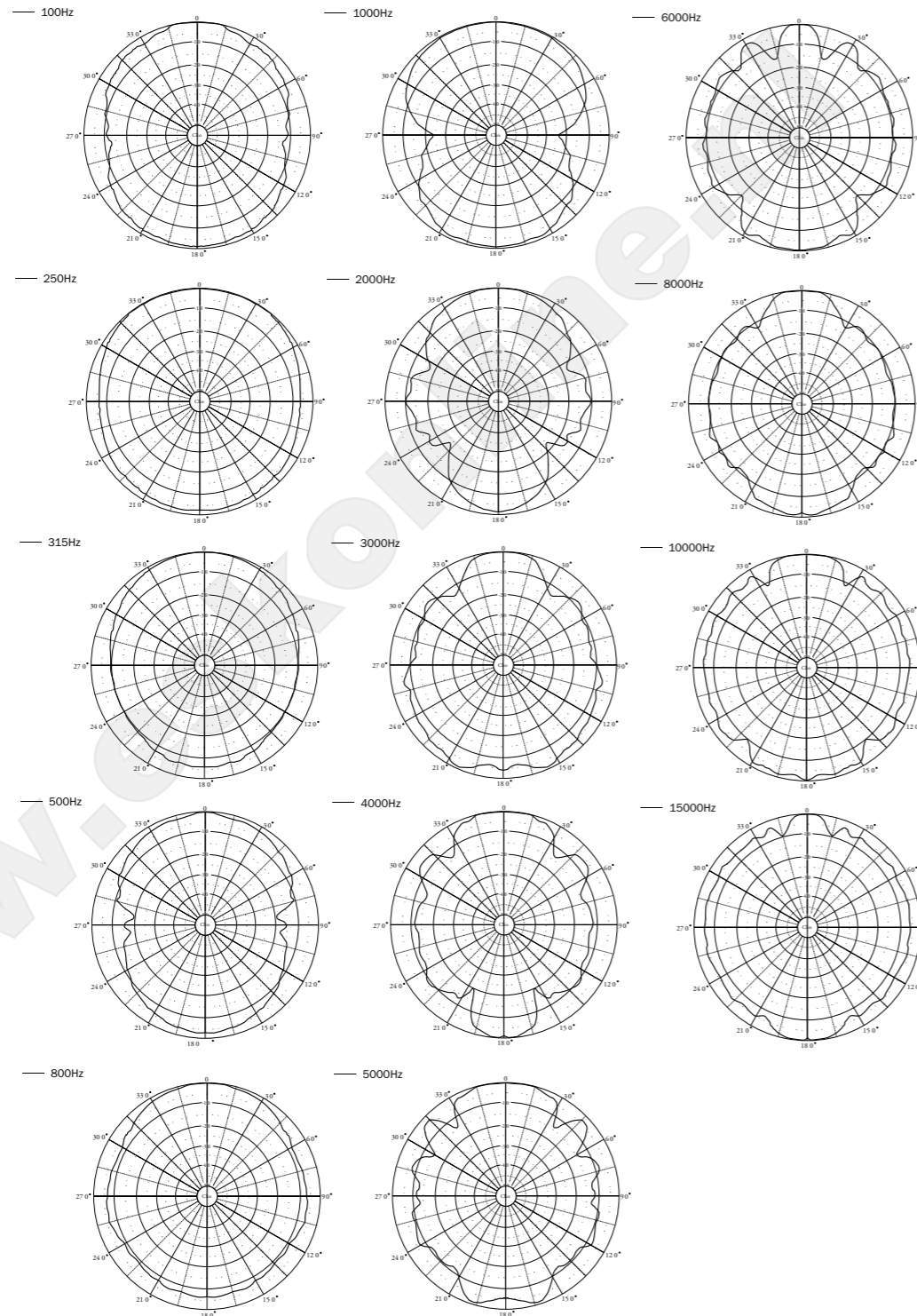

Final Adjustments

After you have finalised the position of the loudspeakers you should level the speaker by adjusting the feet.

Tensioning the Speaker

This is the final adjustment. Tighten the tensioner clockwise. This pulls the tensioning bar tight and makes the assembly rigid. As this significantly improves performance at high power levels, do not omit this stage. The tensioner should be periodically checked to ensure the speaker is fully rigid as temperature and humidity variations may cause the tension to slacken slightly.

After all the adjustments have been completed, gently drop the connection panel cover into place.



Mounting Alternatives

After finalising the position of the loudspeakers, for added safety and to improve the coupling with the floor still further, the loudspeakers may be screwed to the floor.

Disconnect each loudspeaker from the mains supply and the amplifier. Mark the position of all four feet with tape or chalk. Place a soft towel or similar item on the floor and lay the loudspeaker carefully on its front. Remove the stabilising block. Undo the collars on the rear feet half a turn to loosen the bracket and rotate each bracket so that it is facing the rear of the loudspeaker. Retighten the collars.

Floor Spikes on Carpet: The pointed foot should only be used with carpets. Adjust the rear feet so that the tapered section of the spike protrudes below the bottom of the bracket. When you screw the bracket into the floor through the carpet, the bracket will rest on the carpet thus avoiding damage to the carpet surface.

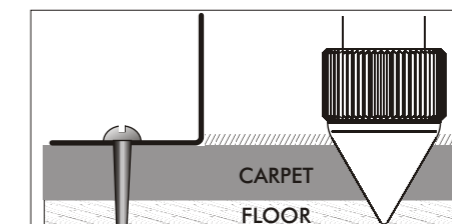

Standard Feet: The bottom of the floor clamp should be marginally above the bottom of the foot. Make sure the feet rest firmly on the floor and that the bracket is not supporting the weight of the loudspeaker.

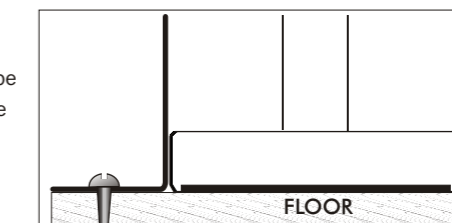

Stand the speaker upright. Carefully manoeuvre the loudspeaker so that the feet are standing on their marked locations. Now screw the clamps to the floor using suitable screws and fixings.

Check that both front feet support the speaker. Reconnect both loudspeakers to the amplifier and the mains supply.

Specifications

SPECIFICATION	ESL 2805	ESL 2905
---------------	----------	----------

CONSTRUCTION

Format:	Floor Standing Dipole With 3° Fixed Tilt Back	
Type:	Multiple Electrostatic Drive Membranes	
Membrane:	Ultra Low Mass (0.5gm) Tensioned Film	
Panel Elements:	4	6
Time Delay:	Progressive Concentric Rings	
Chassis Structure:	Heavy Duty Composite Aluminium / Steel	

ACOUSTIC PERFORMANCE

Maximum output:	2 N/m ² at 2m on axis	
Sensitivity:	1.5 mbar per volt referred to 1m. (86 dB/2.83V rms equivalent)	
Impedance:	8 Ohms nominal	
Impedance Variation:	4 - 15 Ohms	4 - 20 Ohms
Maximum Input:	Continuous input voltage (rms): 10V Programme peak for undistorted output: 40V Permitted peak input: 55V	
Frequency Response:	37Hz - 21KHz (-6dB) 33Hz - 23KHz (useable)	32Hz - 21KHz (-6dB) 28Hz - 21KHz (useable)
Directivity Index:	See Polar Diagrams	
Distortion: (100dB at 1 metre)	Above 1000Hz 0.15% Above 100Hz 0.5% Above 50Hz 1.0%	Above 1000Hz 0.15% Above 100Hz 0.5% Above 50Hz 1.0%

ELECTRICAL

AC Input:	220-240V or 110-120V	
Power fuse:	63 mA anti-surge, 200-240V 100 mA anti-surge, 100-120V	

GENERAL

Power consumption:	6W	
Dimensions: (HxWxD)	1040mm x 695mm x 385mm (add 25 - 55mm for feet)	1430mm x 695mm x 385mm (add 25 - 55mm for feet)
Weight:	Net 34.8 kg	Net 41.6 kg

All measurements made with a 230V AC supply

The right is reserved to alter performance and specification as required

This equipment complies with the radio interference requirements as laid down in EU regulations

Horizontal Directivity

These are actual measurements taken from our reference samples. The directivity pattern is exceptionally well maintained from very low frequencies to well beyond audibility. This consistent pattern ensures smooth spatial response with no peaks and troughs. In addition, the virtually massless diaphragms of the ESL ensure near-instantaneous starting and stopping with an almost total absence of hysteresis, providing lightning fast transients and phenomenal bass response.

► Quad ESL 2805

Horizontal Directivity

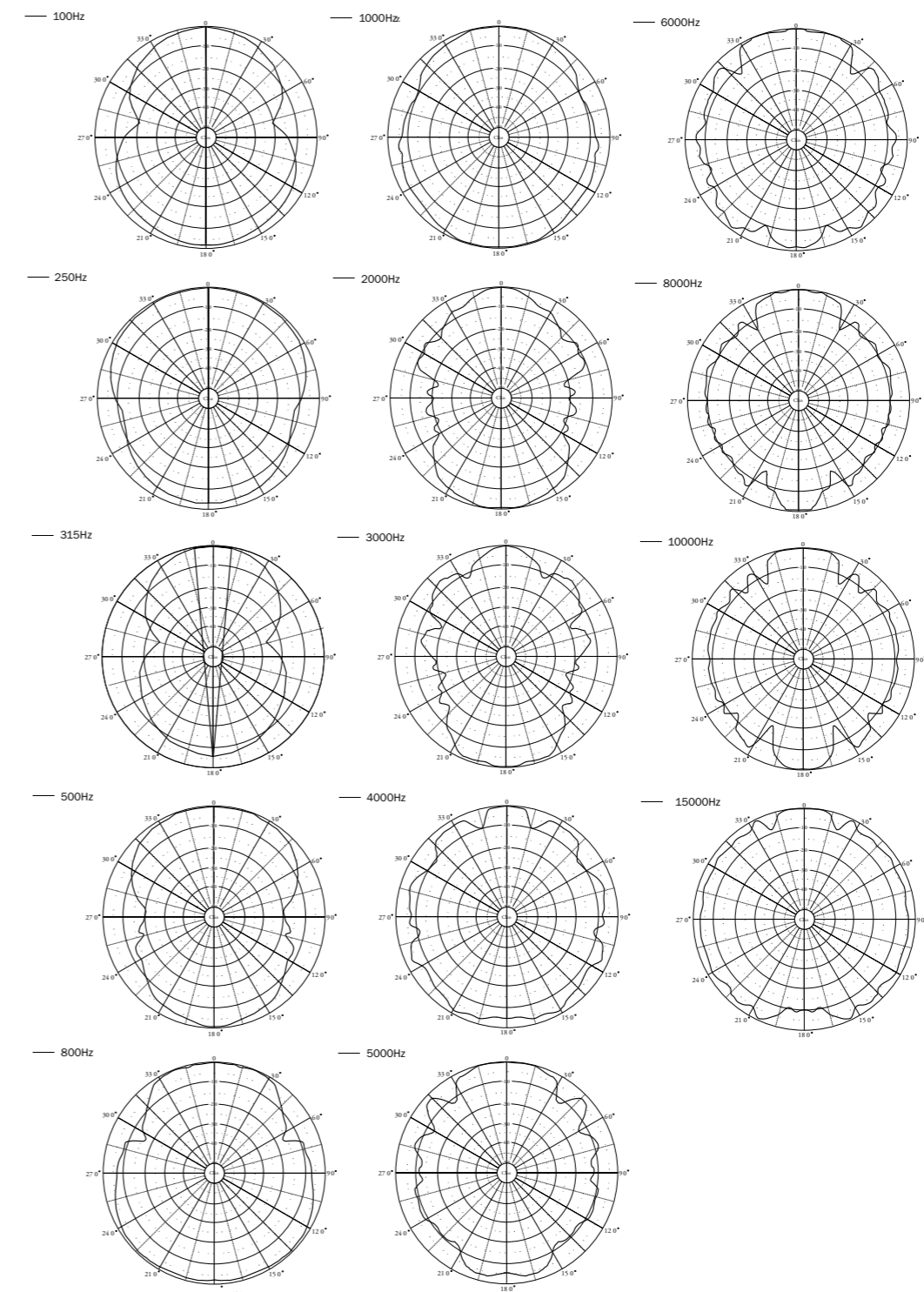

Operation

The ESL loudspeaker requires an energising voltage for operation and needs to be connected to an AC power supply. Before connecting to the AC power supply check that the voltage range marked on the base corresponds with that of the supply.

The on/off switch has a rocker action; press the bottom to switch the ESL on and the top to switch it off. An LED next to the on/off switch indicates that the speaker is on. As supplied, the Quad logo on the speaker bezel is switched off. To switch it on, turn the Front Light Control clockwise so that it clicks. The intensity of illumination may also be altered via this control.

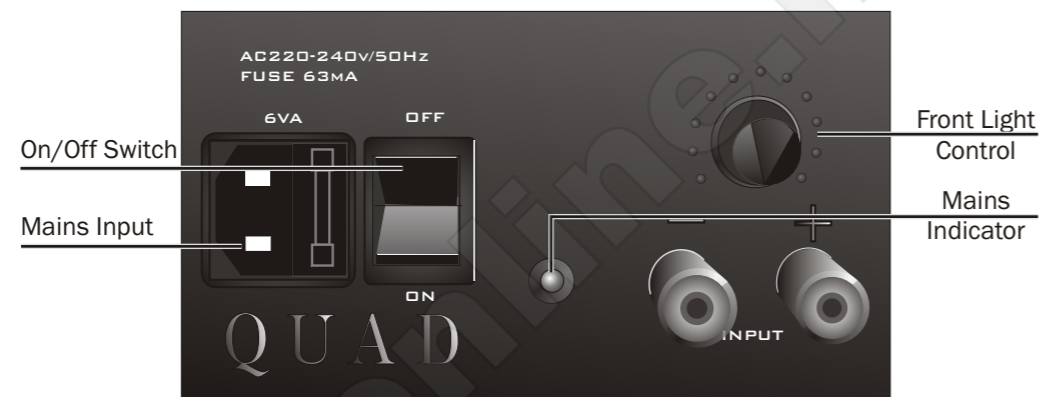

Amplifier Requirements

The ESL loudspeaker should be used with an amplifier of output capability of 20V - 30V rms (40-100W into 8 Ohms). The impedance characteristic presents no problems to the amplifier. Protection circuits limit the maximum input voltage to 40V and there is no benefit from using an amplifier with an output greater than 30V rms (100W into 8 Ohms). Amplifiers with an output capability in excess of 35V rms (150W into 8 Ohms approx) may be used but with caution – see Loudspeaker Protection.

If the Quad 405/2 power amplifier is used, the amplifier voltage limiters should not be fitted.

Loudspeaker Protection

The ESL loudspeaker is fitted with a protection circuit, incorporating a special device called a multifuse, which prevents damage from excessive programme input signals. Should the loudspeaker be severely overdriven for any length of time, the circuit will operate and effectively reduce the drive to the loudspeaker, causing a reduction in the volume level with some loss of quality. If this occurs, then the volume control of the amplifier should be turned down. After a delay of a few seconds to allow the circuit to reset, the volume can be increased, but only to a point below which the protection circuit initially functioned, otherwise the circuit may operate again.

Persistently overdriving the loudspeaker will cause the multifuse to completely fail, necessitating its replacement by a qualified engineer. The above conditions are unlikely to occur in normal use or with amplifiers with a power output rating of less than 100W. Steady state signals such as pure sine waves in excess of 10V rms should not be fed to the loudspeaker.

When the AC power to the loudspeaker is switched off or disconnected, the signal input protection circuit operates to prevent excessive signals being fed to the loudspeaker elements. Even so, care should be taken to ensure that the loudspeakers are not driven for long periods (minutes) with no AC power applied.

Care and Cleaning

SWITCH THE LOUDSPEAKERS OFF AND DISCONNECT THEM FROM THE MAINS BEFORE CLEANING.

The surfaces of the speaker should be wiped occasionally with a barely damp soft cloth. The grille cloth may be cleaned with a soft brush or a hand held vacuum cleaner. The loudspeakers are protected against the ingress of dust etc. Regular cleaning is recommended to keep your speakers in pristine condition. Great care has gone into the selection of materials to ensure long term stability under a wide range of temperatures and humidity. In countries where the relative humidity regularly exceeds 90% it is recommended that the listening room be air conditioned for optimum performance.

Servicing

If your Quad equipment requires servicing you should return it to the dealer from whom the equipment was purchased. If you are abroad and there is no suitable dealer in your area, please contact the distributor for the country in which it was purchased or Quad Electroacoustics Ltd. Equipment returned for service should use the original packing. You should enclose a brief note with your name and address and the reason for returning the equipment

Warranty

Your Quad equipment is guaranteed against any defect in material and workmanship for one year from the date of purchase (proof of purchase required). We ask you to complete and return the enclosed Warranty Registration Form (UK). This will also enable us to keep you informed of future Quad products. Within the guarantee period, Quad will undertake replacement of defective parts free of charge provided that the failure was not caused by misuse, accident or negligence. Your statutory rights within the territory in which you purchased the equipment are not affected by this guarantee. Quad carries out a regular review of its products and reserves the right to adjust the specifications and performance from time to time.

There are no user replaceable or serviceable parts inside this equipment. Unauthorised attempts to service or modify this product will invalidate the warranty.

Service Agents Worldwide

U.K.

QUAD Electroacoustics Ltd., IAG House, Sovereign Court, Ermine Business Park, Huntingdon, Cambs PE29 6XU, England
Tel: +44 (0)1480 447700 Fax: +44 (0)1480 431767 www.quad-hifi.co.uk

USA

IAG America, Inc., 15 Walpole Park South, Walpole, MA 02081
Tel: +1 508 850 3950 Fax: +1 508 850 3905 www.iagamerica.com

AUSTRALIA

IAG Australia Pty. Ltd., 30/398 The Boulevard, Kirrawee, NSW 2234, Australia.
Tel: +612 9540 2469 Fax: +612 9540 2855 Email: iagaus@bigpond.com.

CANADA

Korbon Trading Ltd., 6800 Kitimat Road, Units 19-20, Mississauga, Ontario
Tel: +1 905 567 1920 Fax: +1 905-567-1929 www.korbon.com

GERMANY

IAG Germany Ltd., IAG(Deutschland) GmbH Johann-Georg-Halske-Str. 11-41352 Korschenbroich.
Tel: +49(0)2161-61783-0 Fax: +49(0)2161-61783-50 Email: info@wharfedale.de

HONG KONG

Sanecore Limited., Room 2607, 26/F., ING Tower, 308 Des Voeux Road, C., Sheung Wan, Hong Kong.
Tel: +852 2581 9178 Fax: +852 2581 9717 Email: info@sanecore.com

R.O.C.

Sea Power Co. Ltd., 4/F, No.5 Wu Chung 2th Road, WuKu Industrial Area, Taipei County, Taiwan, R.O.C.
Tel: +886-2-2298-2688 Fax: +886-2-2298-2396 Email: haikuo@ms23.hinet.net

Positioning the Loudspeakers

However good the loudspeaker, the final results will depend on the acoustic characteristics of the listening room and the position of the loudspeakers in it. Do not be afraid to experiment with both position and orientation and make a point of trying some of the less obvious as well as the more obvious positions. The benefits obtained from the time spent doing this can be very rewarding. The subject of room acoustics is complex and beyond the scope of this manual. It is assumed that the loudspeakers will be used in a room with moderate reverberation, neither too bright nor over damped. Furnishings can alter the acoustic characteristics of the listening room, and here common sense is the best guide.

The loudspeakers have constant directivity over a wide angle in both horizontal and vertical planes, so the response does not vary with the height of the listener's ears from the floor.

When experimenting, it is preferable to use good recordings or works with which you are familiar in the concert hall or good quality speech.

The ESL loudspeaker, being a dipole source, has considerable advantages over conventional loudspeakers in terms of room placement. No energy is radiated in the plane of the diaphragm and as a consequence, the respective axial room modes are discriminated against. Normally the loudspeaker is placed at an angle to both horizontal room axes. This will excite both sets of horizontal axial modes although this excitation will be 3 dB less than with a conventional source and discriminate entirely against the vertical axial modes.

The loudspeakers should be placed at least 60cm (2 ft) from the rear wall of the listening room and angled towards the listener. Placing the ESLs too close to rear walls will adversely affect their dispersion characteristics. It is not advisable to operate the loudspeakers across corners, in alcoves or behind furniture. Because ESLs are a homogeneous sound source it will be found that they can be placed considerably further apart than normal, broadening the stereo sound stage. Close proximity to the side walls is not detrimental to performance. Simple geometry will show that if the ESL is placed at an angle to the side wall, there will be no audible reflection at the listening position.



About your ESL loudspeaker

Your ESL loudspeaker consists of a vertical multiple element or membrane line array mounted on top of an electronic matching circuit contained within the base structure.

In order to achieve the efficiency needed for full range audio operation a large moving diaphragm is required. This is achieved using several individual elements connected within a rigid frame. The smaller ESL 2805 features 4 elements, whilst the ESL 2905 features 6 elements.

The membrane (diaphragm) in each element is a highly charged ultra thin, immensely strong plastic film, pre-stretched and fixed to an open frame. To achieve constant-charge conditions this membrane is coated with a specially formulated high-resistivity coating. This membrane is one tenth of the thickness of a human hair and virtually massless compared to other types of loudspeaker. Again, unlike a conventional loudspeaker, the membrane when energised is driven simultaneously over its entire surface. This combination results in an extremely fast transient response - the diaphragm responds to alternating motion without introducing any time lag - completely unlike the sluggish, high-mass conventional loudspeaker.

The ESL is a dipole - the sound radiates equally from both sides of the diaphragm.

The centre two panels in each loudspeaker incorporate divisions in the diaphragm. These can be seen as concentric rings on the outer grid plates surrounding the diaphragm. Each ring is subjected to a minuscule time delay and attenuated by its own individual circuit, the sound spreading gradually from the centre outwards through each successive ring. This carefully structured delay line creates a near-perfect spherical wave front originating from an apparent point 400mm behind the loudspeaker. In the vertical plane the elements are line arrayed, the mid and high frequency elements being centrally sited to preserve the spherical shape.

In order to eliminate even the slightest cancellation effect caused by diaphragm motion interacting with the speaker frame, the base is weighted at the rear with a steel mass spaced away from the cabinet base. An adjustable strut further increases rigidity and improves cabinet coupling. The result is a structure of immense stability and rigidity.

The ultimate design goal of any high-fidelity loudspeaker is faithfully to preserve the illusion of a naturally occurring sonic event. That this is fully realised by the Quad ESL in practice can be seen from the loudspeakers' polar plots reproduced on Pages 9 and 10. These loudspeakers give a truly three dimensional sound stage like no other.

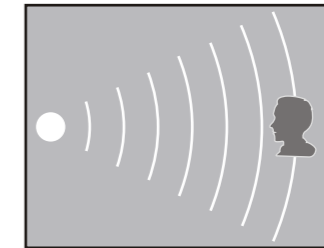

1: A perfect point source produces a spherical wave pattern

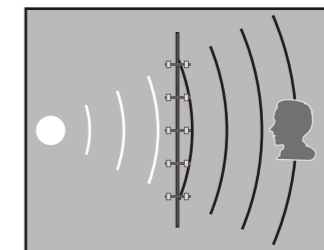

2: Air particle movement at a plane some distance from the source

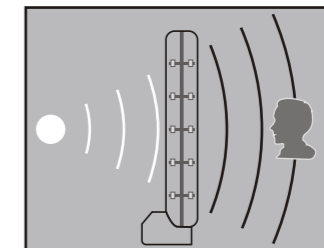

3: An identical movement in the ESL membrane produces an identical wave front

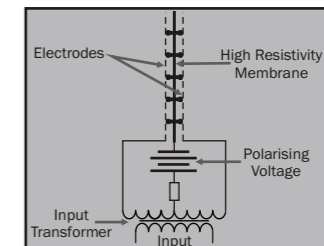

4: The membrane carries a constant charge. The charge on the electrodes fluctuates according to the music signal

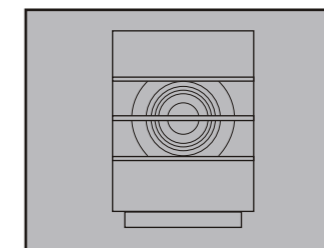

5: The music signal is fed first to the centre section, then to each ring in turn via delay coils

What's in the Box?

The packaging contains the following items:

- o The Quad ESL loudspeaker
- o AC power lead 3m with a mains connector suitable for your area
- o This Instruction Manual
- o Warranty Registration Form
- o A set of four spiked feet
- o A set of four standard feet
- o Four clamping collars
- o One collar locking bar
- o Base Stabiliser Weight
- o Two securing brackets, screws and shakeproof washers.
- o Two pairs of cotton gloves

Consult the dealer from whom you purchased the equipment if any of these items is not present.

Please retain the packing materials for future use or return them to your dealer. If you decide not to keep the packing, please dispose of it sensibly. The timber, paper and plastics components are recoverable and may be taken to an appropriate recovery service.

Please retain the user manual and the information concerning the date and place of purchase of this equipment for future reference. In the unlikely event that you pass this product on to a third party, please include all the accessories and this instruction manual.



Stage 4

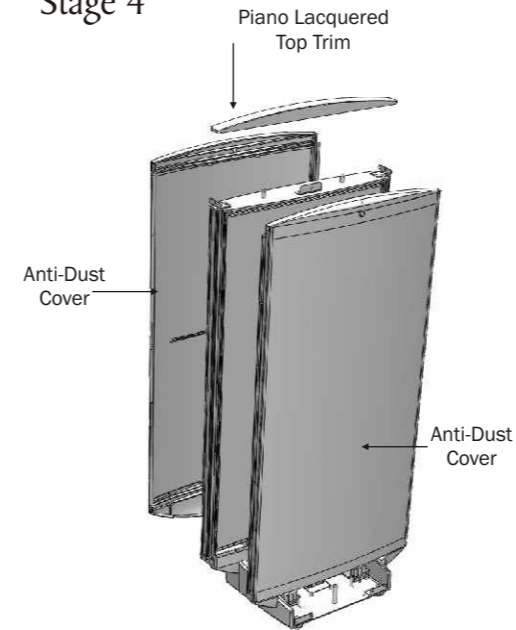

Stage 5

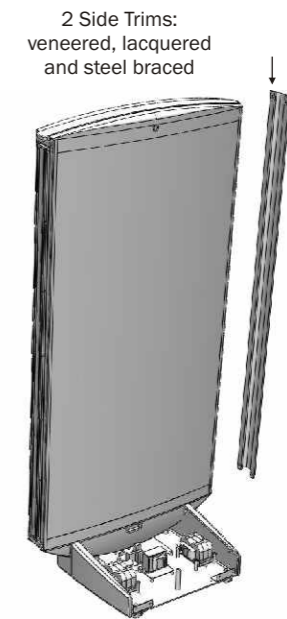

Stage 6

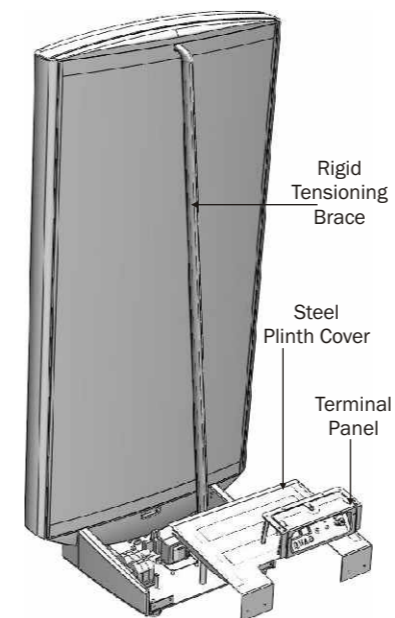

Stage 7



READING ORDER

	COVER		
CAUTIONS	IFC	1	INTRO/CONTENTS
WHATS IN THE BOX	2	3	UNPACKING
POSITIONING	4	5	CONNECTING
OPERATION	6	7	FINAL ADJUSTMENTS
SPECS	8	9	POLAR -1
POLAR -2	10	11	SERVICE AND WARRANTY ADDRESSES
ABOUT YOUR ELS	12	13	HOW IT WORKS
MAKING AN ELS-1	14	15	MAKING AN ELS-2
QUAD BOOK	16	IBC	

PRINTING ORDER

	COVER		
CAUTIONS	INSIDE COVER		
QUAD BOOK	16	1	INTRO/CONTENTS
MAKING AN ELS-1	14	3	UNPACKING
ABOUT YOUR ELS	12	5	CONNECTING
POLAR -2	10	7	FINAL ADJUSTMENTS
SPECS	8	9	POLAR -1
OPERATION	6	11	SERVICE AND WARRANTY ADDRESSES
POSITIONING	4	13	HOW IT WORKS
WHATS IN THE BOX	2	15	MAKING AN ELS-2