

Nakamichi

CR-7E/CR-5E

Discrete Head Cassette Decks



The Most Convenient... And Simple Recording Instruments Conceive



In cosmetics and design, the CR-7E and CR-5E mate with Nakamichi Series-7 and Series-5 electronics although either functions perfectly in any system. *Either* can be connected to the Nakamichi CA-7E Control Amplifier and operated via the CA-7E's System Remote Control, but neither *need* be operated that way. The CR-7E comes with a wireless remote control unit; the CR-5E is compatible with the optional RM-200 Remote Control.

Remote Control Of
Playback Azimuth

Sophisticated... Designed By Man.

The Unique Combination

Never before has cassette recording been so convenient—and so good! The CR-7E and CR-5E Discrete Head Cassette Decks combine the features you've been looking for with the crystal-clear sound that is a Nakamichi hallmark.

Both decks utilize Nakamichi's Microprocessor-Controlled Direct-Drive Asymmetrical-Dual-Capstan Transport, Discrete-Head Technology, and high-performance electronics to ensure unparalleled sonic accuracy—and *much* more!

If you're a casual recordist, you'll appreciate the ability of these decks to sense tape type and set bias and equalization automatically; if you're a serious audiophile, you'll appreciate the ability to *override* the automatic system and choose EQ manually for special situations. And, either way, you'll appreciate the central display that alerts you to every important switch setting.

The CR-5E lets you adjust bias for best recording. The CR-7E goes a giant step further with automatic adjustment of bias, recording level and playback azimuth for perfect recordings on virtually *any* tape formulation.

CR-7E Discrete Head Cassette Deck

The epitome of convenience and performance! Automatic calibration of playback azimuth, bias and recording level with independent memory banks for the three major tape types. Manual control of playback azimuth too—even from your armchair via a wireless remote control. An accurate real-time counter with Auto Fade at the end of side and a special 2-second peak-hold on its 50-dB level indicators.

CR-5E Discrete Head Cassette Deck

Traditional Nakamichi technologies such as Discrete Three-Head recording and playback, the Asymmetrical Dual-Capstan transport, and low-noise/low-distortion electronics make this deck a top performer. Automatic Tape/EQ setting with manual override and Bias Tune to match each tape for best performance. Remote control either via the CA-7E Control Amplifier or RM-200 Remote Control Unit.



CR-7E Auto Calibration More
Precise Than Manual Adjustment

Auto Calibration Azimuth/Bias/Level (CR-7E)

Even among cassettes of the *same type*, differences exist from one to the next; among brands, all bets are off! To realize any tape's *full* potential, the recorder's bias and Dolby calibration must be adjusted to match *that* tape's characteristics. Auto Calibration simplifies this task but *conventional auto-calibration decks are as likely to miscalibrate as they are to calibrate correctly!* The reason? Azimuth error!

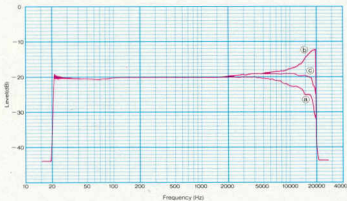

(a) Frequency response with proper bias and equalization. High-frequency loss due to azimuth misalignment.
(b) Frequency response after auto calibration on properly aligned deck. High-frequency rise due to miscalibrated bias and/or equalization.
(c) Frequency response after auto calibration on auto-calibrating deck. Response seems "flat" but deck has underbiased and/or over-equalized the tape to compensate for azimuth error.

Figure 1 Auto Calibration With Azimuth Error Of 10.4'
Deck: CR-7E/Level: -20dB/PB Eq: 70µs/Tape: ZX (Metal)

The causes of azimuth misalignment are explained below. Suffice it to say here that when azimuth error is ignored on an auto-calibrating deck, serious problems ensue. When a deck "auto calibrates," it tests response by recording and reproducing a series of tones. On playback, each tone is checked and bias, recording EQ or both are adjusted until the proper levels are achieved.

In principle, the procedure is fine: in practice, it results in *miscalibration unless the playback head is perfectly aligned with the recording head.* Figure 1 shows what happens with a 10.4' azimuth misalignment. Curve (a) is the response with *proper* bias; the high end rolls off because of the azimuth error. The

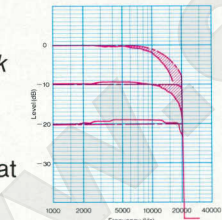

Dotted Line: Frequency response with proper calibration
Solid Line: Frequency response with excessive recording equalization (miscalibration)
Shaded Area: Loss in dynamic range due to miscalibration
Figure 2 Dynamic Range Loss Due To Equalization Miscalibration
Deck: CR-7E/PB Eq: 70µs/Tape: ZX (Metal)

auto-calibration circuit interprets the loss as a *bias or EQ error* which it should "fix." After calibration, the deck *seems* to have the response shown in (c) but, in actuality, it has underbiased the tape, used excessive recording EQ (or both) in order to compensate for *azimuth* error. When the tape is reproduced on a *properly* aligned deck, the response *rises* as in (b).

It would have been better *not* to have "auto-calibrated!" Not only does the response rise, but if the deck "did its thing" by underbiasing the tape, dropouts and distortion increase and dynamic range is reduced. If the deck "fixed" the error by boosting EQ, it runs out of headroom. Figure 2 shows what happens. The dotted curves show the response of a properly calibrated tape, the solid curves the response with excessive recording equalization, and the dynamic range between them *is lost!*

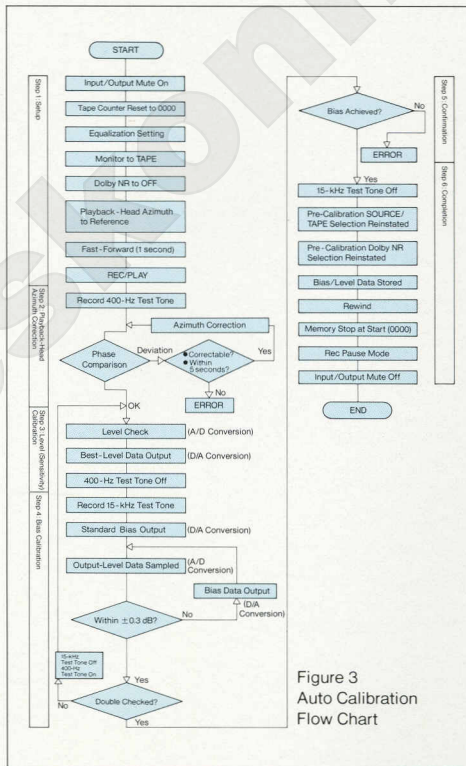

Figure 3 Auto Calibration Flow Chart

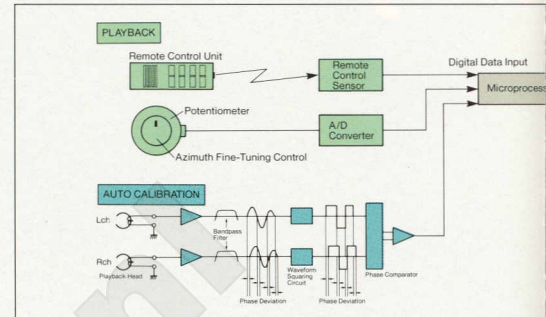

Figure 4 Playback-Head Azimuth-Alignment System Block Diagram

The CR-7E features a radically new and improved Auto-Calibration system that ensures accurate calibration by *aligning play-head azimuth as a first step.* The azimuth-alignment and auto-calibration procedure takes about 15 seconds to complete and is controlled by a new 6-bit/64-step microprocessor.

Nakamichi Auto Calibration

The procedure follows the flow chart of Figure 3. Azimuth alignment is first tested by the time-proven "phase-comparison" method outlined in Figure 4. If an interchannel phase error is detected, play-head azimuth is adjusted in 1.3' steps until the error is corrected and that correction is confirmed *10 times.*

Once the head is aligned, Dolby level is checked at 15 points, independently in the left and right channels, and the gain of each recording amplifier is adjusted to ensure Dolby tracking within 0.3 dB. Bias is adjusted by recording a 15 kHz tone and checking playback level at 15 points independently in the two channels. Bias is adjusted and the playback level rechecked until 15 kHz response is within 0.3 dB of nominal. Since bias and sensitivity are interrelated, the calibration procedure is repeated a second time.

Once the deck is calibrated, the microprocessor stores the bias and level data in memory. Separate memories are provided for each tape type (I, II, and IV) so the proper values are recalled the next

Azimuth misalignment... The Achilles' Heel of cassette recording.

As tape passes over the record-head gap, it receives a magnetic imprint that is roughly proportional to the current through the record-head winding. When the tape subsequently passes over the play-head gap, the pattern is sensed and generates a voltage across the play-head winding. However, unless the play-head gap is perfectly aligned with the recording, treble response is diminished. This, in a nutshell, is the "azimuth-alignment problem." It is especially severe in the cassette format because, at slow tape speed, each cycle of high-frequency signal occupies an extremely short length of tape.

Figure 6 graphs the loss as a function of frequency for various azimuth errors. Even with a tiny 5' error (1/12°), there is a 2-dB loss at 20 kHz. With a more typical error—10' or 1/6°—there's a 2-dB loss at 10 kHz and almost a 10-dB loss at 20 kHz. Companding noise-reduction systems such as Dolby-B and -C NR exacerbate the problem. Figure 7 compares the actual response curves of a recorder with and without Dolby-C NR, with two different azimuth errors. As you can see, Dolby-C NR more than doubles the loss in both cases!

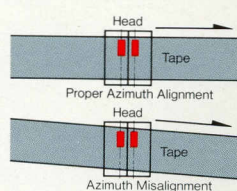

Figure 5 Azimuth Misalignment

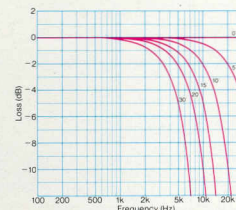

Figure 6 Azimuth Misalignment Loss vs Frequency

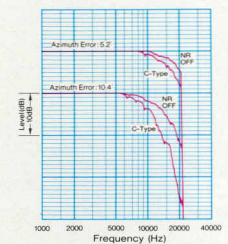

Figure 7 Frequency Response With 5.2' & 10.4' Azimuth Error With & Without Dolby-C NR
Deck: CR-7E/Level: -20dB/PB Eq: 70µs/Tape: ZX (Metal)

Nakamichi Technology Discrete-Head Recording/Asymmetrical-Dual

With the exception of Auto Calibration, Azimuth Alignment and a few special features found only on the CR-7E, the CR-5E and CR-7E are virtually identical. Both use the special technologies that make a Nakamichi cassette deck unique in the industry.

Discrete Three-Head Technology

Nakamichi invented the "3-Head" cassette deck more than a decade ago. From that day to this, to Nakamichi, a "3-Head" deck means three *discrete* heads—heads that are physically, electrically and magnetically independent. Only a Discrete-Head deck can extract *total* performance from a cassette because only *discrete* heads can be individually optimized and aligned for perfect results.

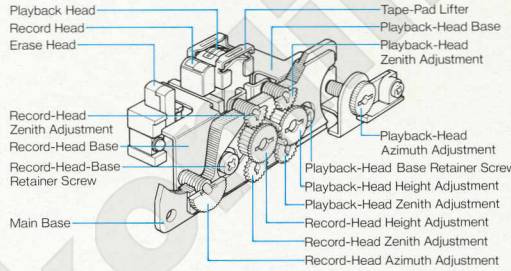
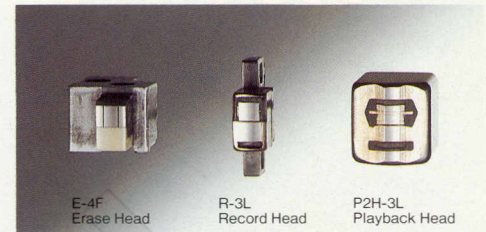

Figure 8 Discrete Three-Head Mounting Arrangement

Most 3-head decks use "sandwich" heads—separate record and play sections in the same housing. Once the head is made, there's no way to align the gaps (much less implement an auto azimuth-alignment system!) Even if the gaps are aligned mechanically during construction—no mean feat since they must be parallel within 0.1 micron (4 millionths of an inch!)—there's no guarantee that they will be *magnetically* aligned.

With both cores in the same structure, there's little room for shielding. Bias and signal leak into the playback gap and upset Dolby tracking when monitoring. If an auto-calibration system is used with such a head, this "crossfeed" *by itself* causes miscalibration!



With Nakamichi Discrete-Head Technology, these problems don't exist. Not only can the two gaps be individually optimized, but the heads can be shielded from each other to eliminate crossfeed and magnetically aligned to each other after the deck is fully assembled.

Figure 8 shows the mounting arrangement used in the CR-7E/CR-5E. Each head has its own height, azimuth and zenith (tilt) adjustments which are separately aligned to sub-micron tolerances to ensure ideal performance.

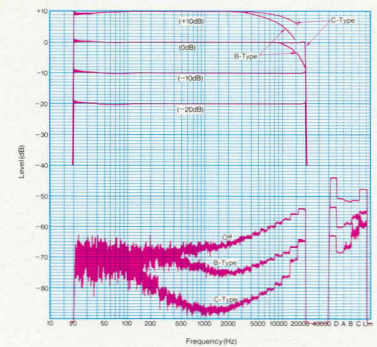
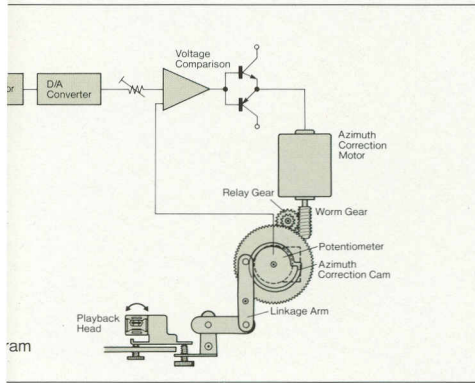

Figure 9 CR-7E Frequency Response/Noise Analysis
Deck: CR-7E/Tape: ZX (Metal)/PB Eq: 70µs/MPX Filter: Off

The record and play heads use the famous Nakamichi laminated-Crystalloy core—fabricated by an exclusive process that eliminates physical stress. Thus, the magnetic properties of the material are fully preserved, a fact proven in performance. As Figure 9 indicates, CR-7E response is within ± 3 dB from 18 Hz to 21,000 Hz at -20 dB and almost equally good at 0 dB with Dolby-C NR. Thanks to our special "relieved-surface" architecture and special poletip geometry, head life is over 10,000 hours and bass response is exceptionally smooth.



time a tape of that type is mounted and sensed by the Automatic Tape Selector. At the end of the procedure, the CR-7E rewinds the tape to the point at which it began auto calibrating and enters REC/PAUSE, ready to record.

As explained at the lower left, azimuth misalignment produces serious treble losses which are exacerbated by noise-reduction systems. Of course, the CR-7E reproduces tapes it recorded itself—and tapes recorded on a properly aligned deck—perfectly well. Thanks to its manual play-head azimuth-alignment system, it also can reproduce tapes recorded with *improper* azimuth and produce full-range response.

As shown in Figure 4, the azimuth-alignment mechanism can take commands from three sources: the Auto-Calibration system, a front-panel Playback Azimuth control or via the RM-7C Wireless Remote Control Unit supplied with the CR-7E. When playing a tape of questionable azimuth, you need only adjust the play-head azimuth via the front-panel control or the remote for best treble response. Once you have, you're assured of hearing *everything* recorded on that tape! During correction, one channel of the recording indicator converts to a "relative-azimuth" display to show you how far you've adjusted the head.

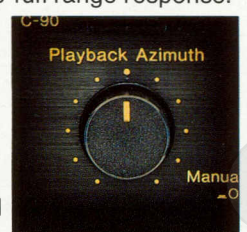

CR-7E
Discrete Head Cassette Deck

-Capstan Transport/High-Performance Electronics

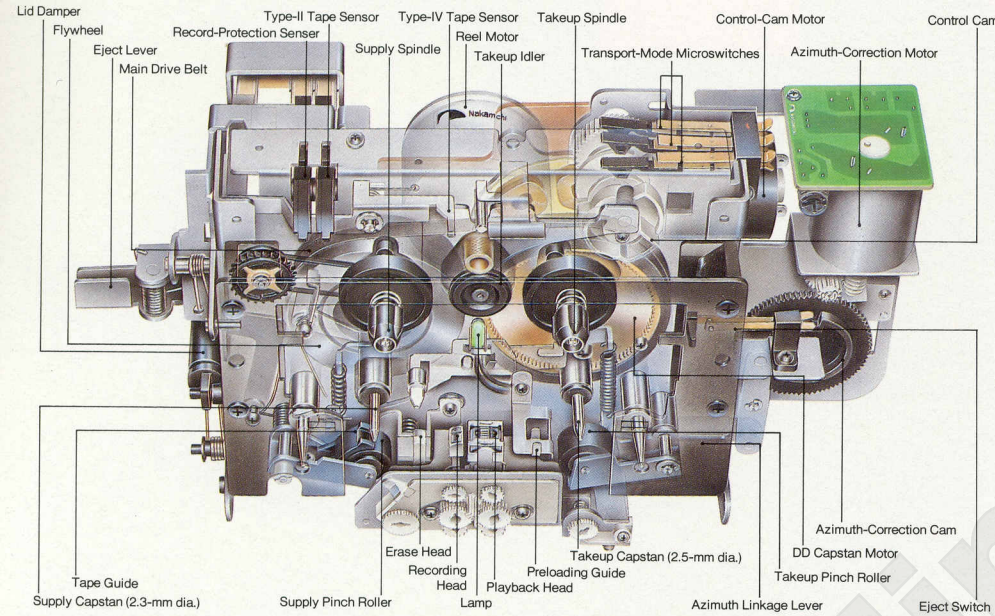

Asymmetrical Dual-Capstan Direct-Drive Transport

Dual-capstan transports differ radically but you wouldn't know it from "weighted" wow and flutter specifications which consider change in pitch (wow) more important than the sour sound produced by fast speed variations (flutter). And, "weighted" specifications entirely ignore scrape flutter and modulation noise—two transport-related problems that *dramatically* reduce clarity.

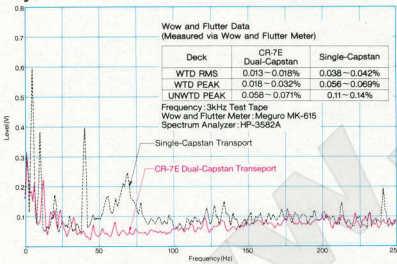

Figure 10 CR-7E Flutter Analysis

Nakamichi believes that pure sound is most important and we've designed the CR-7E/CR-5E transport to ensure just that! Unlike conventional dual-capstan transports, the CR-7E/CR-5E drive is "asymmetric." Capstans and flywheels have different diameters and rotate at different rates to prevent resonance. As a result, wow is reduced and randomized—not concentrated at specific frequencies where it is audible.

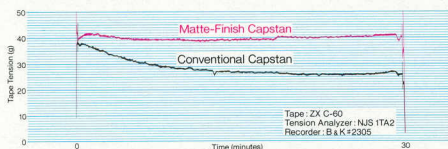
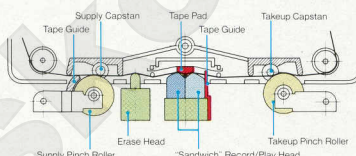

Figure 11 Tape Tension Comparison

Our capstans have a "matte" finish that give them a better grip on the tape.

This, together with a precision reel-drive system, ensures extremely uniform tension—so uniform that the pressure pad isn't needed to maintain tape-to-head contact. A unique "lifter" forces it out of the way. Without the pressure pad to

a) Conventional Dual-Capstan System



b) Nakamichi Dual-Capstan System

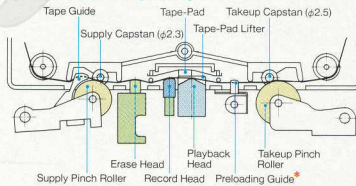

* The preloading guide positions the tape as the pinch roller pulls in. As the roller engages, it lifts the tape away from the guide and the dual-capstan system maintains tracking from then on.

Figure 12 Tape Path In A Dual-Capstan System

cause "skew," the tape tracks with exquisite accuracy so there's no need for a guide between the capstans. Eliminating the pad and guide—an exclusive Nakamichi technology—eliminates the flutter and modulation noise created as the tape scrapes by them and music emerges with the unique clarity called "Nakamichi Sound." The CR-7E/CR-5E Direct-Drive capstan motor is specially designed to suppress the "cogging" that plagues conventional DD transports. It's brushless,

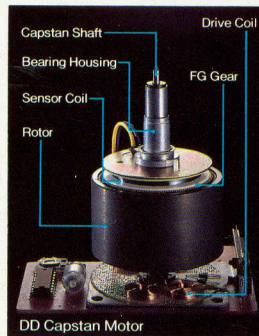

slotless and coreless so torque fluctuations are inherently low. More important, its rotor has an exceptionally high moment of inertia to create a flywheel effect. A 160-segment FG sensor determines motor speed every 2-1/4° of rotation and feeds a wide-bandwidth servo that corrects torque variations occurring at a 1-kHz rate!

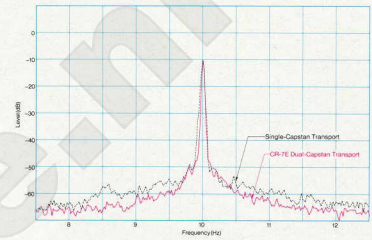
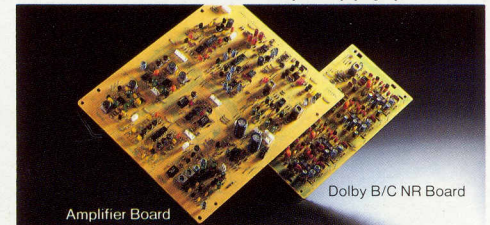

Figure 13 CR-7E Modulation-Noise Analysis
Eq: 70µs/Freq: 10kHz/Tape: ZX (Metal)

The Nakamichi "Silent Mechanism" has been proven in tens of thousands of transports. Its microprocessor-controlled motor engages heads and brakes more smoothly and precisely than a solenoid. There's no shock or vibration for the motor turns only to *change* functions. Cam operation permits the heads to approach the tape rapidly then slow down and ease into place to preserve alignment. Only *after* contact, do the pressure rollers engage thus ensuring stable tape tension from the outset. The transport senses the presence of slack tape as soon as a cassette is mounted and instantly takes up the slack to protect the tape.

High-Performance Electronics

CR-7E/CR-5E electronics are on a par with the finest preamps. Distortion is a mere 0.005%! Record, line and headphone amplifiers are direct coupled to minimize distortion and bipolar powered to maximize dynamic range. The playback preamp uses special FETs in a discrete non-differential configuration that has 3-dB less noise than a differential topology. Leakage current is so low that the play head can be directly coupled to the preamp for minimum noise and distortion. A multi-tap supply provides



independent regulated power to each circuit thus preventing interference between them. Internal shields are strategically placed to prevent noise pickup and Dolby ICs are hand matched to ensure that tracking error is less than 1/4 dB.

A Wide Range Of Features Make The CR-7E/CR-5E Exceptionally Easy To Use

Real-Time Counter (CR-7E) 4-Digit Tape Counter With Memory Stop & Auto Repeat (CR-7E/CR-5E)

The CR-7E real-time counter uses a new microprocessor that operates quite differently from a stopwatch. It indicates elapsed or remaining time, anywhere in the tape pack, *even if you haven't begun counting from the start of tape* and it maintains time during fast winding.

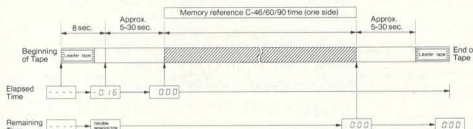

Figure 14 Real-Time Counter Operation

There's no need to wind to the end to "calibrate" the counter. Press TAPE LENGTH until the proper legend (C-46, C-60 or C-90) appears and, when a tape is mounted and run for 8 seconds, the system will indicate either elapsed or remaining time. You choose which by pressing COUNTER MODE to change the display from a conventional tape counter, to the elapsed-time mode, to the remaining-time mode and back. In both time modes, the word "Time" and minute/second indicators appear; in the remaining-time mode, "Remaining" also appears.



CR-7E Tape Counter Display

The CR-7E/CR-5E 4-digit tape counter produces a reading more proportional to the length of tape than is the case with ordinary tape counters. In these decks, the angular speeds of *both* the takeup *and* the supply hubs are measured and fed to a microprocessor that computes the length of tape that has passed.

Both decks feature Memory Stop and Auto

Repeat. With Auto Repeat, the decks rewind the tape at the end (in either RECORD or PLAY) and reinitiate playback. Memory Stop causes the tape to stop at counter "0000" during FAST FORWARD and REWIND.

Auto Fade (CR-7E)

The Nakamichi Auto Fade system featured on the CR-7E eliminates abrupt breaks in the program by automatically fading out the recording shortly before the tape runs out. Pressing AUTO FADE activates the system. Although Auto Fade monitors remaining time via the CR-7E's real-time counter, it functions correctly no matter which counter mode you've chosen.

Auto/Manual Tape/EQ Selection

The CR-7E and CR-5E automatically sense tape type via the keyways molded into modern Type-I, -II, and -IV cassette housings and set standard bias and equalization accordingly. However, unlike other "auto-setting" decks, the CR-7E and CR-5E give you a *choice*.

Pressing MANUAL TAPE EQ, overrides the automatic system so you can choose bias and equalization for yourself. Not only does this permit you to use older cassettes that lack keyways, it gives you the opportunity to use 120- μ s (Type-I) equalization with a Type-II or -IV tape (to increase high-frequency headroom) or 70- μ s equalization with a Type-I tape (to reduce background noise). In either case, the tape and EQ settings in actual use are indicated in the Central Panel. You have the best of both worlds: the convenience of automatic setting, the flexibility of optimizing equalization for special recording situations!

If automatic tape selection is in use, the CR-7E uses the data accumulated by its Auto Calibration system and stored in its memory bank for that tape type; the CR-5E uses standard



values modified by the setting of its Bias Tune control.

Bias Tune (CR-5E)

Although the CR-5E does not have the CR-7E's Auto-Calibration system, it does give you a convenient means of adjusting bias to optimize recordings via its front-panel BIAS TUNE control. Since the CR-5E features off-tape monitoring, you can adjust bias quite accurately by comparing the sound quality of the recording while switching between SOURCE and TAPE. Figure 15 depicts the response range that can be achieved with SX tape.

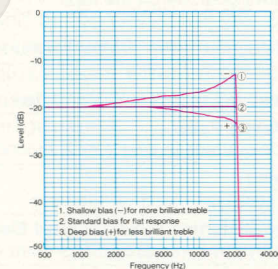

Figure 15 Frequency Response With Bias Fine Tuning
Deck: CR-5E/Level: -20dB/Eq: 70 μ s/Tape: SX

FL Central Display

The CR-7E/CR-5E FL Central Display keeps you advised of every important setting. Of course, there are wide-range (50-dB) peak-responding level meters—with a 2-second "peak-hold" on the CR-7E. The CR-7E meter also converts to a "relative azimuth" indicator whenever you're adjusting azimuth. AZIMUTH/LEVEL/BIAS/READY legends monitor progress during Auto Calibration and blink if Auto Calibration cannot be achieved.

Both displays indicate the MONITOR (Source/Tape), DOLBY (B/C or nothing), TAPE (EX/SX/ZX) and EQUALIZATION (120/70) settings. And both decks show the "MPX Filter" legend when the multiplex filter is engaged. The CR-7E also indicates when its "Subsonic Filter" is active, when "Auto Fade" is on and when the level meters are in the "Peak Hold" mode.



CR-5E

Discrete Head Cassette Deck

CR-7E/CR-5E Feature-Comparison Chart

FEATURE	CR-7E	CR-5E
Auto Calibration Adjusts azimuth, level and bias for optimum recording	•	
Playback Head Azimuth Fine Tuning Control Ensures full-range reproduction of any tape	•	
Discrete Three-Head Technology For maximum dynamic range and most extended response	•	•
Asymmetrical Dual-Capstan Diffused-Resonance Transport Prevents common-mode resonance and maintains constant tension	•	•
Brushless/Slotless/Coreless DD Capstan Motor & FG Servo Reduce wow and flutter to 0.027% (WTD RMS)	•	•
Pressure-Pad Lifter Reduces scrape flutter and modulation noise	•	•
Automatic Slack-Tape Takeup Protects precious tapes	•	•
Auto/Manual Tape & Equalization Selection Auto setting for convenience; manual for special situations	•	•
Real-Time Tape Counter Displays elapsed or remaining time	•	
Auto Fade Fades out recording before end to avoid abrupt transitions	•	
4-Digit Electronic Tape Counter Indicates relative position on the tape	•	•
Memory Stop Stops tape at counter "0000" in fast forward or rewind	•	•
Auto Repeat Rewinds tape at end of side and reinitiates playback	•	
Dual-Speed Master Fader One-touch fade-out/fade-in over 4 or 2 seconds	•	•
Bias Fine Tuning Helps obtain best bias match to the tape	•	•
Low-Noise/Low-Distortion Direct-Coupled Electronics For maximum dynamic range and minimum distortion	•	•
Dolby B/C Noise Reduction Reduces tape hiss by 10 to 20 dB	•	•
FL Central Display Accurate 50-dB peak-level meters with 2-second peak hold (CR-7E only) plus Tape/EQ/Dolby/Filter/Monitor indicators	•	•
One-Touch Rec/Pause Press RECORD to enter Rec Standby, then PLAY to record	•	•
Rec Mute Mutes recording for as long as button is pressed	•	•
MPX Filter Prevents Dolby mistracking when recording FM-Stereo	•	•
Subsonic Filter Prevents tape overload when recording warped discs	•	
Timer Rec/Play Unattended recording or playback via accessory timer	•	•
Wireless Remote Control Permits remote control of transport, REC/PLAY and azimuth	•	
Wired Remote Control Optional RM-200 for remote control of transport and REC/PLAY		•
System Remote Control Remote operation via the CA-7E System Remote Control	•	•
Individual Left, Right & Master Level Controls Establish channel balance and permit manual fades	•	•
Output Level Control & Headphone Jack Matches level to other sources; permits private listening	•	•

CR-7E/CR-5E Specifications

Main Unit	
Track Configuration	4-track/2-channel stereo
Heads	3 (erase head x 1, record head x 1, playback head x 1)
Motors	Tape Transport FG-servo, brushless, slotless, coreless DD motor (capstan drive) x 1 DC motor (reel drive) x 1 Mechanism DC motor (cam drive) x 1 DC motor (azimuth control) x 1 (CR-7E only)
Power Source	220 or 240 V AC; 50/60 Hz (according to country of sale)
Power Consumption	CR-7E: 55 W max. CR-5E: 45 W max.
Tape Speed	1-7/8 ips (4.8 cm/s) ± 0.5%
Wow and Flutter	Less than ± 0.048% WTD Peak Less than 0.027% WTD rms
Frequency Response	CR-7E: 20—20,000 Hz ± 2 dB (ZX, SX, EXII tape) 18—21,000 Hz ± 3 dB (—20 dB recording level) CR-5E: 20—20,000 Hz ± 3 dB
S/N Ratio (A-WTD rms)	Dolby-C NR: Better than 72 dB Dolby-B NR: Better than 66 dB
Total Harmonic Distortion (400 Hz, 0 dB)	Less than 0.8% (ZX tape) Less than 1.0% (SX, EXII tape)
Erasure	Better than 60 dB (100 Hz, + 10 dB)
Separation	Better than 37 dB (1 kHz, 0 dB)
Crosstalk	Better than 60 dB (1 kHz, 0 dB)
Bias Frequency	105 kHz
Input (Line)	50 mV/40k ohms
Output (Line)	1.0 V (400 Hz, 0 dB, Output Level at max.) 2.2k ohms 12 mW into 8 ohms (400 Hz, 0 dB, Output Level at max.)
Fast-Wind Time	Approx. 80 seconds (C-60 cassette)
Dimensions	435(W) x 135(H) x 306(D) millimeters 17-1/8(W) x 5-5/16(H) x 12(D) inches
Approximate Weight	CR-7E: 9.0 kg; 19 lb 13 oz CR-5E: 8.5 kg; 18 lb 12 oz
RM-7C Remote Control Unit (Supplied with CR-7E)	
System	Infrared pulse system
Power Supply	DC 3 V (1.5 V x 2)
Dimensions	57(W) x 19(H) x 175(D) millimeters 2-1/4(W) x 3/4(H) x 6-7/8(D) inches
Approximate Weight	140 g; 5 oz

- Specifications and appearance subject to change for further improvement without notice.
- Noise Reduction System manufactured under license from Dolby Laboratories Licensing Corporation
- The word "DOLBY" and the Double-D Symbol are trademarks of Dolby Laboratories Licensing Corporation.

NOTE: Model Name with "E"

Many countries have safety regulations to which Nakamichi has to comply during production.

The additional mentioning of "E" on the model means that this product has been produced according to the radio interference regulations of the EEC, as well as in compliance to the European safety standards.

Within Europe, Nakamichi only offers guarantee for those products which have been specially produced for the European market.



Tapes
ZX Metalloy Cassette Tape
(70 μ s, metal bias)
ZX C-60 ZX C-90

SX Ferricobalt Cassette Tape
(70 μ s, CrO₂ bias)
SX C-60 SX C-90

SX II Super Ferricobalt Tape
(70 μ s, CrO₂ bias)
SX II C-60 SX II C-90

EX II Ferricrystal Cassette Tape
(120 μ s, normal bias)
EX II C-60 EX II C-90



RM-200 Remote Control Unit

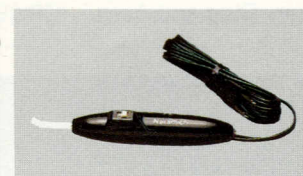

DM-10 Head Demagnetizer



SP-7 Stereo Headphones

Nakamichi Corporation
Tokyo Office
Nakamichi U.S.A. Corporation
Nakamichi GmbH

Shinjuku Daiichi Seimei Bldg., 2-7-1 Nishishinjuku, Shinjuku-ku, Tokyo
Phone: (03) 342-4461 Telex: 2324721 (NAKAMJ)
19701 South Vermont Avenue, Torrance, California 90502 Phone: (213) 538-8150
Stephanienstrasse 6, 4000 Düsseldorf 1 Phone: (0211) 359036